



*PineCar*



*Woodland Scenics*



*Scene-A-Rama*



**WOODLAND SCENICS®**

Quality Brands

2010

# Welcome to the Distinctive World of Woodland Scenics Quality Brands

A rewarding and creative experience awaits you. Simple, fail-safe products for any age and skill level ensure your success. Our commitment to your satisfaction inspires our innovation and fuels our determination to offer the best in quality-tested products.

Thanks to our creative customers who live in the dark-blue areas on the map, we continue to offer the most comprehensive collection of versatile, realistic and easy-to-use products on the worldwide market.

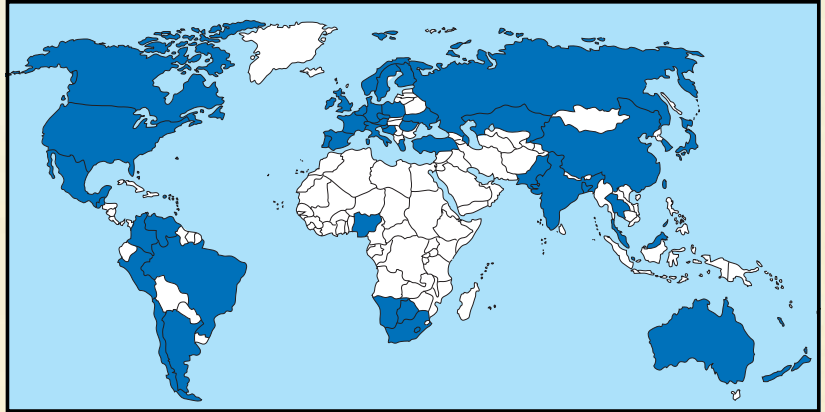

Visit our Web site to locate a retailer near you.

	<b>4-104</b>	<b>Figures &amp; Accents</b>	<b>42-57</b>
<b>Learning Aids</b>	<b>4-5</b>	Bring your layout to life with colorful scenes and tell its story with people, animals and detailed accessories.	
Learn to build a layout from start to finish! Manuals, videos and kits teach you all the easy techniques you need to make terrain and scenery.			
<b>Layout System</b>	<b>6-11</b>	<b>Vehicles</b>	<b>58-62</b>
Use the revolutionary lightweight foam layout system to easily design and create any layout.		Set a realistic stage with a wide selection of vehicle scenes..	
<b>Roadbed</b>	<b>12-13</b>	<b>Buildings</b>	<b>63-90</b>
Create the quietest, smoothest train operation for your layout.		Select from a wide range of structure options to satisfy your modeling preference.	
<b>Terrain &amp; Landscape</b>	<b>14-29</b>	<b>Scene Kits</b>	<b>91-93</b>
Easily create the most realistic scenery available! Everything mixes, blends and works together with natural colors, textures and dimensions.		Model a complete, detailed scene full of life, humor and interest.	
<b>Trees</b>	<b>30-40</b>	<b>Layout Kits</b>	<b>94-99</b>
Add color, texture, geographic perspective and realism to your project. Trees and tree-making products provide limitless possibilities.		Build an amazing layout. These complete kits apply easy techniques for professional results.	
<b>Ready-To-Go Products</b>	<b>41</b>	<b>Decals &amp; Graphics</b>	<b>100-103</b>
Take them home...out of the box...and set them directly on your layout! You will love these ready-to-go landforms, trees, buildings, figures, vehicles and more.		Choose from a variety of easy-to-apply dry transfer decals that include artwork, logos, railroad regalia, numbers and letters.	
		<b>Fasteners &amp; Lubricants</b>	<b>104</b>
		Build, maintain and fine-tune your model railroads, R/C cars and planes, and small household items with quality lubricants and machine fasteners.	

**SCENEARAMA®** **105-116**  
 Spark imagination and make learning fun with this line of products designed to help students create dioramas, displays and other A+ projects.

**PINECAR®** **117-134**  
 Build the fastest racer on the track with this line of easy-to-build car kits, weights, decals, tools and accessories.

**Merchandisers & Assortments** **135-146**  
 Increase product visibility and display appeal with these eye-catching merchandisers, assortments and marketing tools

**Index** **147**

**Catalog pricing is manufacturer's suggested retail and subject to change.**

 **SAFETY INFORMATION**  
 Choking Hazard! Small parts. Not intended for children under 3 yrs.

All products in this catalog conform to Health Requirements of ASTM D4236

Look for these icons adjacent to specific products. They let you know that there is a how-to demonstration of that product on our Web sites. While you're there, learn tips and techniques, print out product instructions, read customer reviews and much more!

**HOW-TO VIDEOS**  
woodlandscenics.com

**HOW-TO VIDEOS**  
scenearama.com

**HOW-TO VIDEOS**  
pinecar.com



*The World Leader in Model Scenery*



**WOODLAND SCENICS®**

2010



## See The Videos...Read The Books

Create your dream layout, diorama or display. There is no need for artistic talent. Our modeling systems are easy and fail-safe. From lightweight layout bases to sculpting any type of terrain and modeling realistic scenery, learning aids teach you everything you need to know about the modeling process and easily walk you through each and every step.

### **SubTerrain: Build a Layout Fast and Easy**

VHS ST1401 - DVD ST1400

**\$24.99**

See how to easily build a model railroad layout in five easy steps with the revolutionary SubTerrain Lightweight Layout System.  
*58 minutes*



### **The Clinic**

VHS R990 - DVD R970

**\$24.99**

Some of the best professionals in the model railroading business demonstrate terrain and landscape techniques to a standing-room-only crowd at a National Model Railroad Association convention.  
*75 minutes*



### **Model Scenery Made Easy**

VHS R993 - DVD R973

**\$24.99**

Watch and learn! This comprehensive video was produced to teach all modelers, from beginner to expert, the simple secrets of creating realistic model scenery.  
*60 minutes*



### **Build a Display for Collectible Houses**

VHS CH1056 - DVD CH1055

**\$19.99**

Learn step-by-step landscape and terrain modeling techniques to build collectible house showpieces to fit in any display area. One-hour video includes complete instructions.  
*60 minutes*



### **SubTerrain Manual** ST1402

**\$8.99**

This illustrated, how-to manual teaches you how to create the ideal lightweight layout for model trains using five easy steps. Over 200 illustrations and photos.  
*80 pages*



### **The Scenery Manual** C1207

**\$11.99**

The most popular model scenery resource in the industry! From the layout base to scenery to the final details, learn the secrets to using more than 600 products to model realistic layouts.  
*142 pages*



This warning applies to all products on this page.



**WARNING:** Choking Hazard! Small parts. Not intended for children under 3 yrs.

## Learning Kits

These value packed tools are specifically developed to teach beginning modelers and other hobbyists how to use Terrain and Landscape Systems. Learn to sculpt terrain, cast, color and install rocks, landscape various scenes, create paved areas, make trees, model water areas and add those crucial finishing touches. These kits are packaged in see-through plastic for easy product visibility and can be resealed to use as storage.



Learning Aids

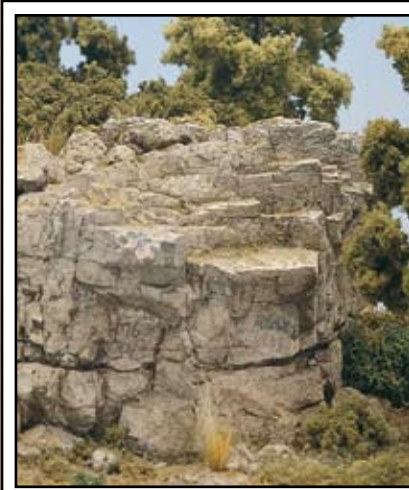

### Rock Faces

**LK951 \$14.99**

Modelers learn to cast, install and color realistic rock formations. The kit contains illustrated instructions, a heavy-duty rubber rock mold and enough of the following products to cast, paint and install four to five rocks: Lightweight Hydrocal\*, Plaster Cloth and Earth Colors Liquid Pigments.

*\*Hydrocal is a product of US Gypsum*



### Road System

**LK952 \$14.99**

Modelers learn to easily add roads and other paved areas to any layout. The kit contains illustrated instructions and enough of the following products to build a roadway approximately 3 in. x 4 ft. long: Smooth-It, Paving Tape & Spreader, Asphalt Top Coat and Top Coat with Applicator.

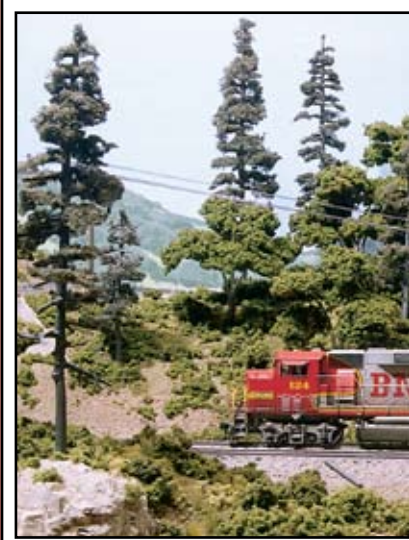

### Trees

**LK953 \$14.99**

Modelers learn to easily add trees to any layout. The kit contains illustrated instructions and enough of the following products to make 18 trees ranging in height from 3/4" to 8": Tree Armatures, Hob-e-Tac Adhesive and Clump-Foliage.

*Kit includes Patented Products*

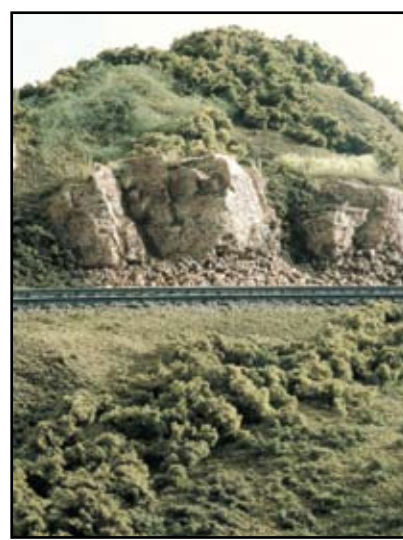

### Landscape

**LK954 \$14.99**

Modelers learn to create beautiful scenery by blending and texturing various types and colors of scenery products. The kit includes illustrated instructions and enough of the following materials to landscape a 2 x 2-foot surface: Earth Undercoat, Scenic Cement, Fine Turf, Clump-Foliage and Coarse Turf.

*Kit includes Patented Products*

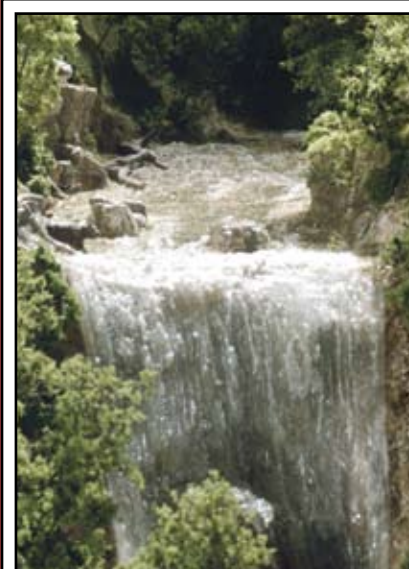

### River/Waterfall

**LK955 \$14.99**

Modelers learn to create the illusion of water depth, make a river and a waterfall. The kit contains illustrated instructions and enough of the following products to model 2 1/2" x 9" river and a 2 1/2" x 4" waterfall: Earth Color Liquid Pigments, Realistic Water, Water Effects, Talus, Plaster Cloth, Green Blend Blended Turf, Scenic Glue and an applicator.

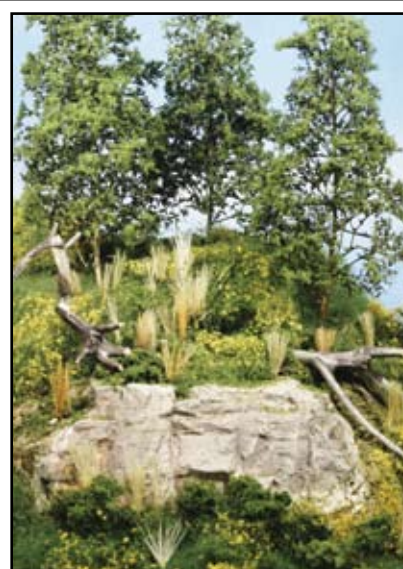

### Scenery Details

**LK956 \$14.99**

Modelers learn simple techniques to create detail on any layout. The kit contains illustrated instructions and enough of the following products to cover a 2 x 2-foot area: Dead Fall, Fine Turf, Bushes, Underbrush, Fine-Leaf Foliage, Field Grass, Flowering Foliage, Poly Fiber and Scenic Glue.

*Kit includes Patented Products*

# SubTerrain Lightweight Layout System

The layout building process has been revolutionized! Easily construct your model train layout using the most advanced foam system available. The innovative, high-density SubTerrain foam components are extremely lightweight and simple to use. Modeling with the SubTerrain system leaves no dusty mess and requires no previous experience, complicated calculations or expensive power tools.



- **No Experience Necessary**
- **No Complicated Calculations**
- **No Expensive Power Tools**
- **No Dusty Mess**

## Risers

High-density foam Risers are used to elevate track. With the surrounding areas now lower, modelers can quickly and easily create creek beds, ravines and other low-lying areas without the mess and inconvenience of expensive power tools.

### Without Risers

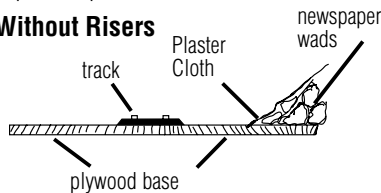

### With Risers

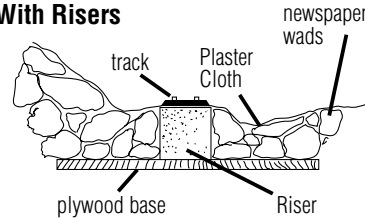

### What Size Do I Need?

Risers are available in 1/2", 3/4", 1", 2" and 4" heights. We recommend using at least a 2" Riser to elevate your track. This will provide moderate elevation for gradual relief, hills and creek beds. For a more dramatic landscape, use a 4" Riser to give you maximum elevation for steep relief, rivers and valleys.

Generally, 1/2", 3/4" and 1" Risers are used in conjunction with Incline Starters.

## Incline Sets

change elevation

### 4% Incline Sets (4 pieces)

Changes elevation from 0"-4" in 8'.

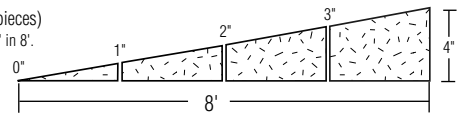

Sets allow a smooth transition from one height to another.

### 3% Incline Sets (6 pieces)

Changes elevation from 0"-4 1/2" in 12'.

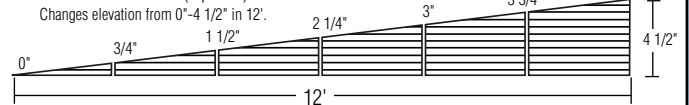

### 2% Incline Sets (8 pieces)

Changes elevation from 0"-4" in 16'.

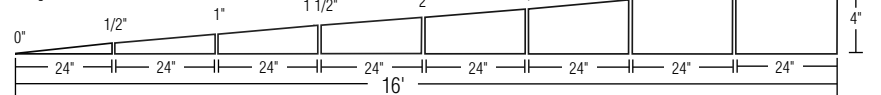

## Incline Starters

add versatility

### 2% Starter

(Package includes 8 identical 2' sections)

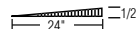

### 3% Starter

(Package includes 6 identical 2' sections)



### 4% Starter

(Package includes 4 identical 2' sections)

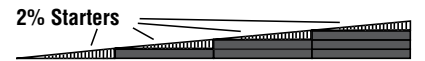

Starters can be used with Risers to build smooth inclines.

## Use Risers and Inclines for Unlimited Possibilities

Optional combinations make any situation possible.

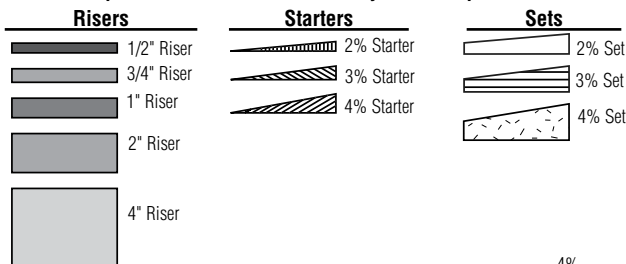

The following illustration shows how using Sets, Starters and Risers in combination give you the flexibility to make the most complex layouts simple.

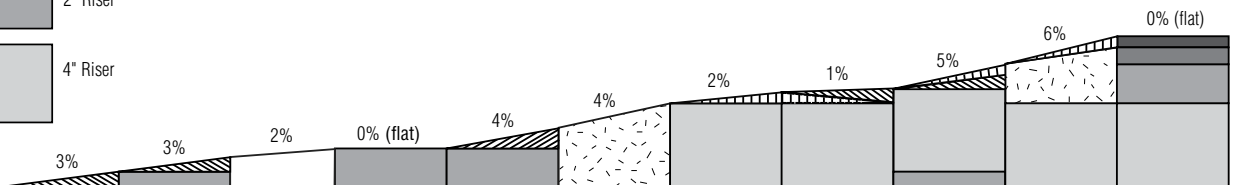

### Risers

Patented Product



Risers are easily flexed to form curves and can be used on a plywood or foam base. Use at least 2" Risers to elevate your track. To install, butt sections tightly, pin in place with Foam Nails and attach with Low Temp Foam Glue or Foam Tack Glue. Each piece is 2 1/2" wide x 24" long.

1/2" (4 per pkg.)	ST1406	\$6.49
3/4" (4 per pkg.)	ST1414	\$7.49
1" (4 per pkg.)	ST1407	\$7.99
2" (4 per pkg.)	ST1408	\$9.99
4" (2 per pkg.)	ST1409	\$9.99

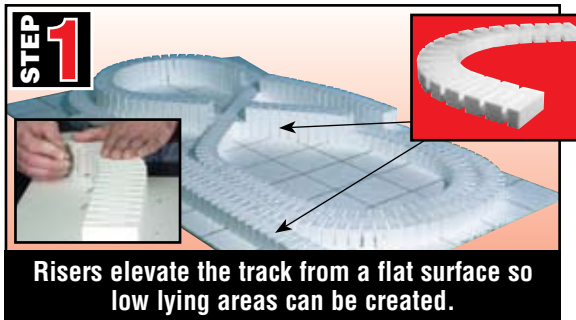

Risers elevate the track from a flat surface so low lying areas can be created.

### Incline Sets and Starters

Patented Product



Inclines are flexible and allow a smooth transition from one height to another. To install, center the Incline on the Riser, butt sections tightly, pin in place and attach with Low Temp Foam Glue or Foam Tack Glue. Starters are identical pieces that can be used alone, or with Sets to start your track on an incline. Each piece is 2 1/2" wide x 24" long.

2% SET (8 per set) Elevates track 4" in 16'	ST1410	\$19.99
3% SET (6 per set) Elevates track 4 1/2" in 12'	ST1416	\$19.99
4% SET (4 per set) Elevates track 4" in 8'	ST1411	\$13.99
2% STARTER (8 per pkg.) Raises the elevation 1/2"	ST1412	\$6.49
3% STARTER (6 per pkg.) Raises the elevation 3/4"	ST1415	\$6.49
4% STARTER (4 per pkg.) Raises the elevation 1"	ST1413	\$6.49

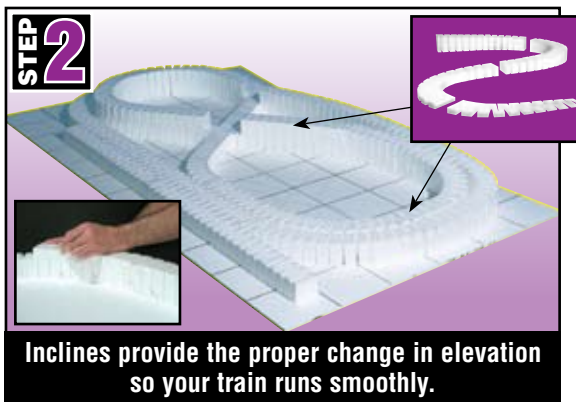

Inclines provide the proper change in elevation so your train runs smoothly.

### Profile Boards™

Profile Boards create the perimeter of your layout to define the contours. Their special interlocking design makes them easy to join together with the use of matching Connectors. They can be placed end-to-end, or stacked and locked together, then trimmed with a Hot Wire Foam Cutter to create mountain profiles.



Each Profile Board is 8" tall x 24" long.

2 Boards and 2 Connectors	ST1419	\$9.99
---------------------------	--------	--------

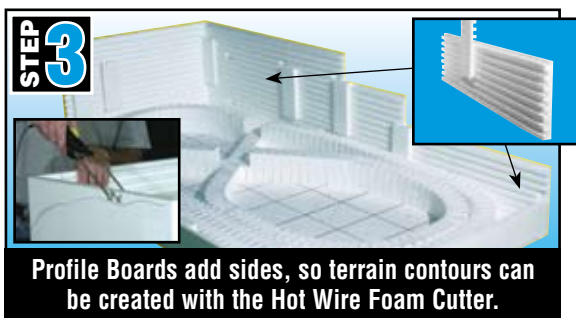

Profile Boards add sides, so terrain contours can be created with the Hot Wire Foam Cutter.

### Foam Sheets

Use Foam Sheets to create flat areas for towns. Also use for tunnels, contour supports, plus layout and diorama bases.



Build supports with scrap foam to elevate the Foam Sheets and attach with Low Temp Foam Glue or Foam Tack Glue. The 1/4" sheet can be bent into a radius. Each piece is 12" wide x 24" long.

1/4" (1 pc.)	ST1422	\$3.99
1/2" (1 pc.)	ST1423	\$4.49
1" (1 pc.)	ST1424	\$5.99
2" (1 pc.)	ST1425	\$12.99
3" (1 pc.)	ST1426	\$15.99
4" (1 pc.)	ST1427	\$18.99

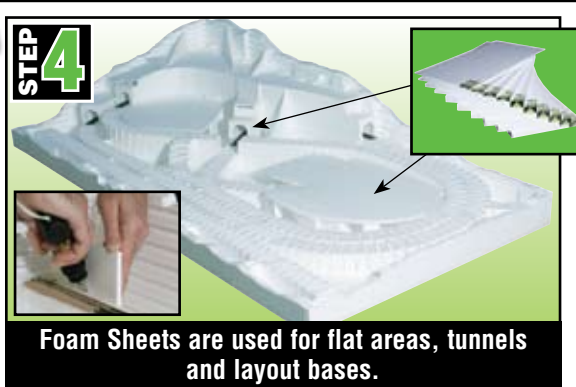

Foam Sheets are used for flat areas, tunnels and layout bases.

### Plaster Cloth C1203

\$8.99



A simple, convenient and lightweight way to create a durable terrain shell. Just wad newspaper and stack to form desired terrain areas. Hold the wads in place with masking tape. Dip Plaster Cloth in water and smooth over terrain areas. The Plaster Cloth will dry to a hard shell.

8" wide x 15' long roll, 10 sq. ft.



Plaster Cloth covers newspaper wads to create a hard shell for landscaping.

**Foam Pencils ST1431 \$4.99**

Foam Pencils have a special lead designed to draw on foam without causing damage. The colors will not bleed through paint or other coverings.  
2 red, 2 black

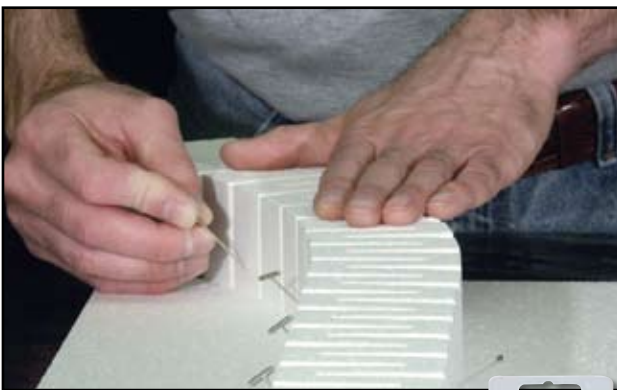

**Foam Nails ST1432 \$5.99**

Use Foam Nails to temporarily pin Track-Bed, track, foam or other products to your layout. 2"- 75/pkg.



**Foam Knife ST1433 \$7.99**

The Foam Knife comes with a 2-inch replaceable blade that is ideal for cutting thick pieces of foam.  
1 knife/pkg.



**Foam Knife Blades ST1434 \$6.49**

Replacement blades for Foam Knife.  
4 blades/pkg.



**Foam Tack Glue™ ST1444 \$11.99**

This specially formulated glue is high tack and effective on most materials, especially foam. Use as a contact cement whenever bonding two large surfaces.  
12 fl. oz.

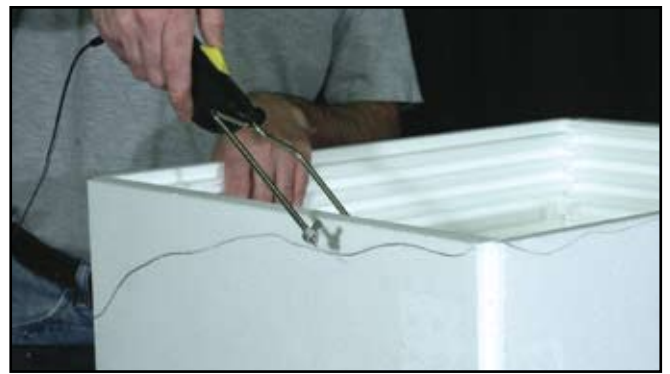

**Hot Wire Foam Cutter ST1435 \$39.99**

The Hot Wire Foam Cutter has adjustable collars, for clean, accurate cuts. The cutting path is 4 1/2" w x 6" d. Woodland Scenics recommends using this cutter only on SubTerrain white foam. Only use the special Nichrome replacement wire.

Add versatility to your Foam Cutter with the Bow & Guide.  
Input: 120 VAC  
Output: 9 VAC  
1300mA



**International Hot Wire Foam Cutter \$39.99**

**230V Hot Wire Foam Cutter**..... ST14401  
(Transformer/Plug Europe)

**230V Hot Wire Foam Cutter**..... ST14402  
(Transformer/Plug UK)

**240V Hot Wire Foam Cutter**..... ST14403  
(Transformer/Plug Australia/New Zealand)

**Hot Wire Foam Cutter Replacement Wire ST1436 \$2.49**

Special Nichrome wire retains an even temperature needed to cut our foam products.  
4 feet



**Foam Cutter Bow & Guide ST1437 \$7.99**

The Bow attachment adds versatility to the Hot Wire Foam Cutter. Attach the Guide for precise angled cuts (handle not included).







**Low Temp Foam Glue Gun** ST1445 **\$16.99**  
**Low Temp Foam Glue Sticks** ST1446 **\$6.49**

This low temp glue will not damage foam and bonds instantly. Load the glue sticks in the barrel, then use the trigger to dispense.



110V  
 10 sticks/pkg. (10" long)



**Foam Putty™** ST1447 **\$8.99**

Foam putty is non-shrinking, lightweight filling material that has the same characteristics as foam, and is used to fill cracks and gaps.  
 16 oz. vol./28 cu. in.



**Flex Paste™** C1205 **\$19.99**

This flexible, non-cracking modeling paste can be used to create a hard surface or as a filler or primer on foam. It can also be used as a road base or sealer under model water. Excellent for modeling heavy snow drifts. Apply Flex Paste and sprinkle Soft Flake Snow on top.  
 16 fl. oz.



## Road System

Use to make any asphalt or concrete surface, such as roads, streets, sidewalks or parking lots. Accomplish in three easy steps. Refer to page 5 for the Road System Learning Kit (LK952).



**1** Apply Paving Tape.

**Paving Tape™** ST1455 **\$7.99**

This adhesive-backed foam tape is used to create a form for making streets, roads, sidewalks and parking lots. A 5 1/4" wide smoothing spreader is included. Thirty feet of tape makes a road approximately 15 feet long.  
 1/4" x 30'



**2** Spread Smooth-It.

**Smooth-It™** ST1452 **\$5.99**

This plaster material is used to fill the forms created from the Paving Tape. It can also be used to fill rough areas on streets and roads.  
 1 qt./55 cu. in.



**3** Paint with Top Coat.

**Top Coat™ Asphalt** ST1453 **\$4.99**  
**Top Coat™ Concrete** ST1454 **\$4.99**

Use full-strength or dilute with water. For blacktop surfaces use Asphalt Top Coat. Color highways, streets and sidewalks with Concrete Top Coat.  
 4 fl. oz.

This warning applies to all products on this page.  **WARNING:** Choking Hazard! Small parts. Not intended for children under 3 yrs.

## Mod-U-Rail System

**MOD-U-RAIL**  
**SYSTEM**

Use the Modu-U-Rail System to design, build and landscape a layout customized to your specific space requirements. It is the easy, lightweight and durable alternative to traditional bench work and includes the landscape materials for the finishing touch. Mod-U-Rail is for scales from O through Z.



- No complicated calculations
- No expensive power tools
- No mess
- Cost savings over purchasing items separately

**HOW-TO VIDEOS**  
woodlandscenics.com

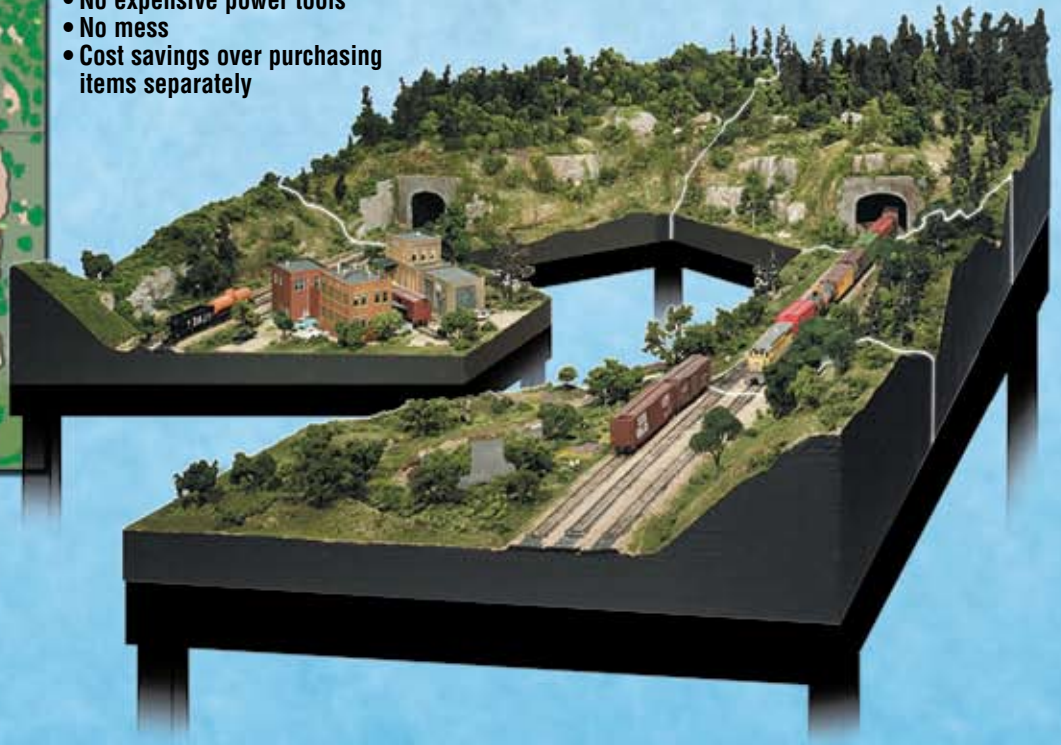

**Design**—Designing your layout is easy. Visit our Web site to use the free, interactive design program. The program leads you through a simple, visual process to design a customized layout to fit your personal space requirements. Design your layout with an endless number of configuration possibilities, track-planning patterns and techniques.

**Build**—Simply construct modules for the layout base with the patented SubTerrain Lightweight Layout System components. Bolt modules together in the customized prearranged plan you designed.

**Landscape**—Each module kit includes Woodland Scenics realistic and high quality scenery materials. Bring your layout to life with a variety of pigments, turfs, foliages, talus, ballast, rocks and more!

**FREE Module Kit**—Purchase any five Straight and (or) Corner Kits to receive a Free Straight Module Kit (ST4801).

### Straight Module Kit\* ST4801

\$135.99

- 18 x 36-inch module



\*Track not included.

### Corner Module Kit\* ST4802

\$155.99

- 36 x 36-inch module
- Can also be built as a square



### N SCALE TRACK PLANS INCLUDED IN KITS

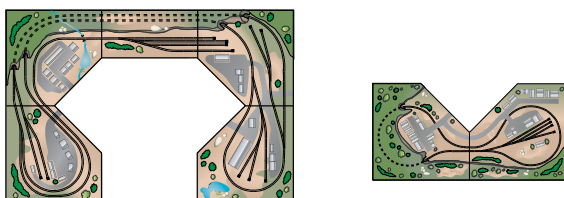

### HO SCALE TRACK PLANS INCLUDED IN KITS

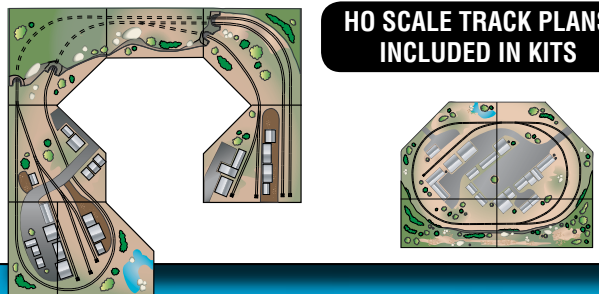

This warning applies to all products on this page.



**WARNING:** Choking Hazard! Small parts. Not intended for children under 3 yrs.

### Connector Plate Set ST4780

**\$12.99**

The Connector Plate Set was developed to expand Mod-U-Rail layout possibilities. In addition to bolting the individual modules end-to-end, you can bolt them side-by-side.

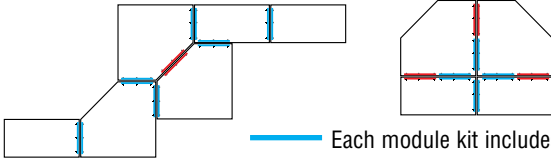

— Each module kit includes two connector plates with hardware for bolting end-to-end.  
— The Connector Plate Set gives you additional connectors for unlimited possibilities in your layout design.

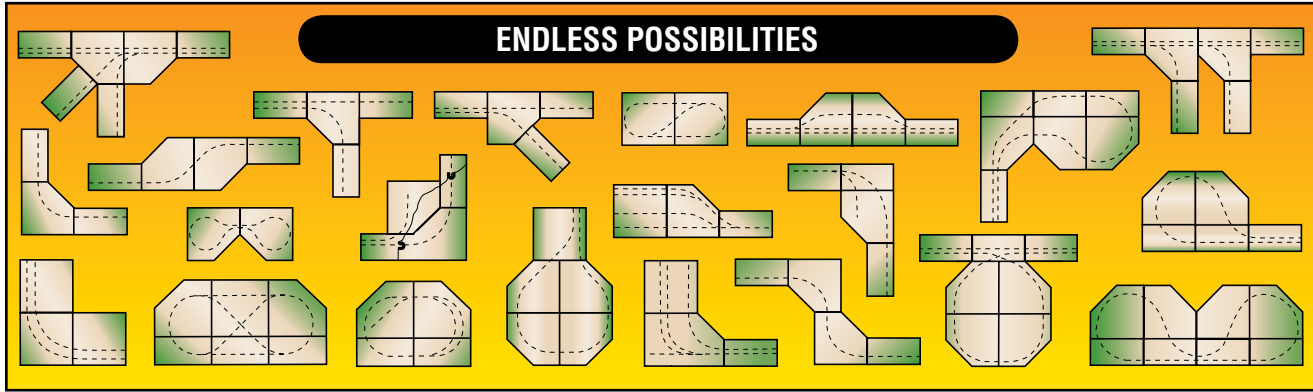

### Mod-U-Rail Kit Stands

Pre-measured, pre-cut and pre-drilled, these wood stands form fit your layout modules. They are lightweight, durable, sturdy and easy to assemble. All the necessary hardware is included. Each stand is 35 1/2" tall with adjustable feet to simplify leveling. Bolt stands in any configuration to match your custom layout design, and paint if desired.

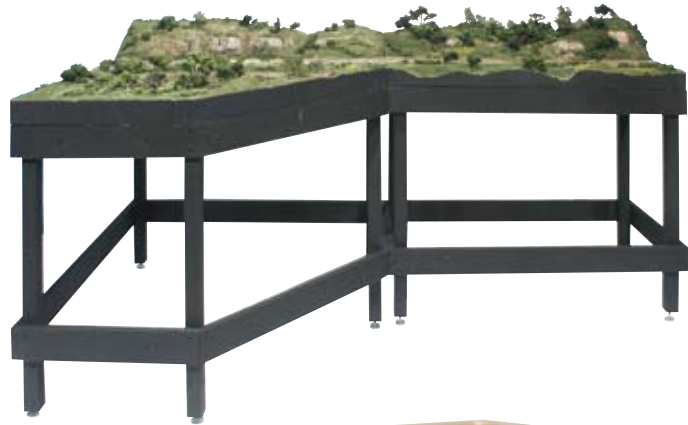

#### Straight Module Kit Stand

ST4790 **\$29.99**

18" x 36" x 35 1/2" - 22 lbs.



#### Corner Module Kit Stand

ST4791 **\$34.99**

36" x 36" x 35 1/2" - 27 lbs.



#### Square Module Kit Stand

ST4792 **\$34.99**

36" x 36" x 35 1/2" - 26 lbs.

### Mod-U-Rail DVD ST4799

View this introductory DVD on our Web site or for a copy, send us your name and address along with \$5.00 for shipping and handling.



# Track-Bed



This roadbed product is a high-quality, economical alternative to other roadbeds, provides a quiet, smooth train operation and absorbs irregularities on your layout. It aligns well with cork on any layout, but unlike cork, requires no pre-soaking, remains flexible and won't dry out or become brittle. Track-Bed is available in Rolls, Strips, Sheets and Super Sheets. Available in N, HO and O Scales.

Patented Product

## Rolls

Track-Bed Rolls offer a smooth, almost seamless application.

- N Scale** (3mm x 1 1/4" x 24' - Seamless Roll) .....ST1475 **\$7.29**
- HO Scale** (5mm x 1 3/4" x 24' - Seamless Roll) .....ST1474 **\$9.99**
- O Scale** (5mm x 2 3/4" x 24' - Seamless Roll) .....ST1476 **\$14.49**



## Strips

Use Track-Bed Strips for easy application. They are especially good for tight areas.

### Standard Pack

- N Scale** (3mm x 1 1/4" x 24" - 12 pieces per pkg.) .....ST1472 **\$7.29**
- HO Scale** (5mm x 1 3/4" x 24" - 12 pieces per pkg.) .....ST1471 **\$9.99**
- O Scale** (5mm x 2 3/4" x 24" - 12 pieces per pkg.) .....ST1473 **\$14.49**

### Bulk Pack

- N Scale** (3mm x 1 1/4" x 24" - 36 pieces per pkg.) .....ST1462 **\$19.59**
- HO Scale** (5mm x 1 3/4" x 24" - 36 pieces per pkg.) .....ST1461 **\$29.59**
- O Scale** (5mm x 2 3/4" x 24" - 36 pieces per pkg.) .....ST1463 **\$42.69**

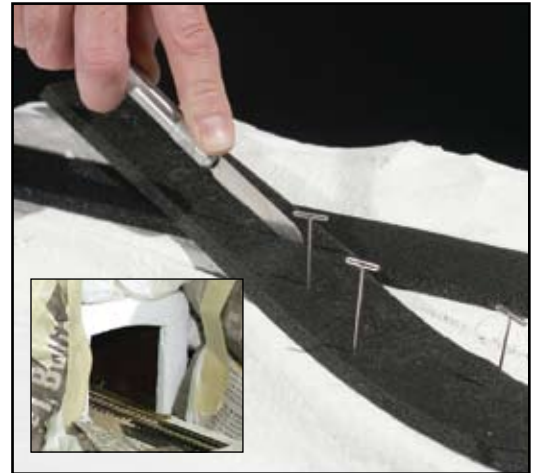

## Sheets

Use Track-Bed Sheets for rail yards or sidings.

- N Scale** (3mm x 3 1/4" x 24" - 6 pieces per pkg.) .....ST1460 **\$7.99**
- HO/O Scale** (5mm x 5" x 24" - 6 pieces per pkg.) .....ST1470 **\$13.99**



## Super Sheets

Track-Bed Super Sheets are great for rail yards or sidings.

- N Scale** (3mm x 12" x 24" - 1 each) .....ST1478 **\$3.69**
- HO/O Scale** (5mm x 12" x 24" - 1 each) .....ST1477 **\$4.59**



This warning applies to all products on this page.



**WARNING: Choking Hazard! Small parts. Not intended for children under 3 yrs.**



Roadbed

**Ballast**

Bag - \$3.99, Bag (45 cu. in.) - \$8.99, Shaker - \$10.99

In the real railroad world, ballast forms the rail's track-bed and holds the track in place. Our Ballast realistically models this effect and is available in a variety of grades and colors. Mix and match for authentic reproductions. Ballast is lightweight and easy to use. Attach with Scenic Cement. *Bags 18 cu. in. (Gray Blend 45 cu. in.)/Shaker 50 cu. in.*

**GRADES**

*Shown actual size*



**Fine**



**Medium**



**Coarse**



**COLORS**



**Iron Ore**

**Fine** B70 (Bag)  
**Med.** B77 (Bag)  
**Coarse** B84 (Bag)



**Dark Brown**

**Fine** B71 (Bag)  
**Med.** B78 (Bag)  
**Coarse** B85 (Bag)



**Brown**

**Fine** B72 (Bag)  
B1372 (Shaker)  
**Med.** B79 (Bag)  
B1379 (Shaker)  
**Coarse** B86 (Bag)  
B1386 (Shaker)



**Buff**

**Fine** B73 (Bag)  
B1373 (Shaker)  
**Med.** B80 (Bag)  
B1380 (Shaker)  
**Coarse** B87 (Bag)  
B1387 (Shaker)



**Light Gray**

**Fine** B74 (Bag)  
B1374 (Shaker)  
**Med.** B81 (Bag)  
B1381 (Shaker)  
**Coarse** B88 (Bag)  
B1388 (Shaker)



**Gray**

**Fine** B75 (Bag)  
B1375 (Shaker)  
**Med.** B82 (Bag)  
B1382 (Shaker)  
**Coarse** B89 (Bag)  
B1389 (Shaker)

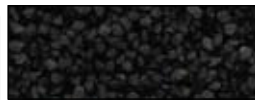

**Cinders**

**Fine** B76 (Bag)  
B1376 (Shaker)  
**Med.** B83 (Bag)  
B1383 (Shaker)  
**Coarse** B90 (Bag)  
B1390 (Shaker)



**Gray Blend**

**Fine** B1393 (Shaker)  
**Med.** B94 (Bag, 45 cu. in.)  
B1394 (Shaker)  
**Coarse** B1395 (Shaker)

**SCALE REFERENCE CHART: BALLAST**

SCALE	FINE	MEDIUM	COARSE
Z	2.2"-7.3"	7.3"-11"	11"-18.3"
N	1.6"-5.3"	5.3"-8"	8"-13.3"
HO	.9"-2.9"	2.9"-4.3"	4.4"-7.2"
S	.6"-2.1"	2.1"-3.2"	3.2"-5.3"
O	.5"-1.6"	1.6"-2.4"	2.4"-3.9"
1	.3"-1"	1.1"-1.6"	1.6"-2.6"
G	.24"-.8"	.8"-1.2"	1.2"-1.9"

**Coal**

\$3.99

To model realistic-looking coal, use Coal in piles or in wagons and freight cars to model. *9 cu. in.*



**Mine Run**

B92



**Lump**

B93



**SCALE REFERENCE CHART: COAL**

SCALE	N	HO	O
B92	0"-12"	0"-6"	0"-3"
B93	8"-20"	4"-10"	2"-5"



## Terrain System

Model any type of landscape and produce spectacular results with the complete Terrain System. Each product includes easy-to-follow instructions and our Web site is loaded with how-to videos, tips and modeling techniques.

### Plaster Cloth C1203 \$8.99

Sculpting with Plaster Cloth is the easiest, most convenient method of modeling lightweight landforms and terrain base. This versatile plaster-coated cloth creates a hard durable shell. Plaster Cloth is designed to accept paints and pigments, plaster castings and landscape materials with realistic effects. Also, use to fill in terrain gaps and sculpt around terrain features.

8" wide x 15' long roll, 10 sq. ft.



### Flex Paste™ C1205 \$19.99

This flexible, non-cracking modeling paste can be used to create a hard surface or as a filler or primer on foam. It can also be used as a road base or sealer under modeled water. Excellent for modeling heavy snow drifts. Apply Flex Paste and sprinkle Soft Flake Snow on top. 16 fl. oz.



### Mold-A-Scene Plaster™ C1202 \$9.99

A versatile amazing material that can be shaped like modeling clay, sets like plaster and also works as a texturing compound! It allows modelers to add terrain contours to new, as well as existing scenery.

1/2 gal./104 cu. in.



### Culverts

HO Scale - \$8.49, N Scale - \$6.99

Where there are embankments, there is water run-off to control. Our Culverts are extremely realistic plaster castings that are easy to color. No serious railroad scene would be complete without a detailed Culvert or two to add realism.



#### Concrete

C1262 - HO Scale (2 each)  
C1162 - N Scale (2 each)



#### Masonry Arch

C1263 - HO Scale (2 each)  
C1163 - N Scale (2 each)



#### Random Stone

C1264 - HO Scale (2 each)  
C1164 - N Scale (2 each)



#### Timber

C1265 - HO Scale (2 each)  
C1165 - N Scale (2 each)

## Retaining Walls\*

HO Scale - \$9.49, N Scale - \$10.99

Retaining Walls are plaster castings that are easy to color. They can be used alone, installed adjacent to each other to create straight or curved walls or used with Tunnel Portals. They can be cut to varying heights to create stepped winged walls.

\*Scale lengths may vary depending on installation.

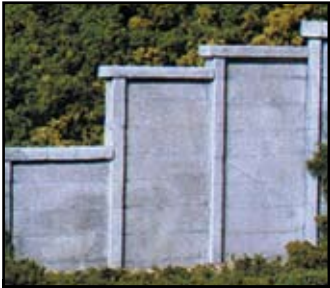

### Concrete

C1258 - HO Scale (3 each)  
2 11/16" x 4 15/16" (58 1/2' scale length)  
C1158 - N Scale (6 each)  
1 5/16" x 2 11/16" (105' scale length)



### Cut Stone

C1259 - HO Scale (3 each)  
3 3/16" x 5 3/8" (69 1/3' scale length)  
C1159 - N Scale (6 each)  
1 11/16" x 2 11/16" (135' scale length)



### Timber

C1260 - HO Scale (3 each)  
2 7/16" x 5 1/16" (53' scale length)  
C1160 - N Scale (6 each)  
1 1/4" x 2 11/16" (100' scale length)



### Random Stone

C1261 - HO Scale (3 each)  
3" x 5" (65 1/4' scale length)  
C1161 - N Scale (6 each)  
1 11/16" x 2 3/4" (135' scale length)

## Tunnel Portals

HO Single - \$8.99 /Double - \$9.99, N Single - \$9.99 /Double - \$10.99

Tunnel Portals are plaster castings that are easy to color with Earth Colors Liquid Pigment. Portals come in single or double track widths.



### Concrete Single

C1252 - HO Scale (1 each)  
Outside: 5 3/8" x 4 7/8" - Inside: 2 11/16" x 3 11/16"  
C1152 - N Scale (2 each)  
Outside: 2 7/8" x 2 1/2" - Inside: 1 7/16" x 1 7/8"



### Cut Stone Single

C1253 - HO Scale (1 each)  
Outside: 5 5/16" x 6 1/16" - Inside: 2 3/4" x 3 3/4"  
C1153 - N Scale (2 each)  
Outside: 3 1/4" x 2 11/16" - Inside: 1 7/16" x 1 7/8"



### Timber Single

C1254 - HO Scale (1 each)  
Outside: 4 7/8" x 5 1/8" - Inside: 2 5/8" x 3 3/4"  
C1154 - N Scale (2 each)  
Outside: 2 5/8" x 2 11/16" - Inside: 1 5/16" x 2"



### Random Stone Single

C1255 - HO Scale (1 each)  
Outside: 5 11/16" x 5 1/8" - Inside: 2 13/16" x 3 3/4"  
C1155 - N Scale (2 each)  
Outside: 3" x 2 11/16" - Inside: 1 5/8" x 1 15/16"



### Concrete Double

C1256 - HO Scale (1 each)  
Outside: 7 3/8" x 4 7/8" - Inside: 4 5/8" x 3 13/16"  
C1156 - N Scale (2 each)  
Outside: 3 7/8" x 2 1/2" - Inside: 2 7/16" x 2 1/16"



### Cut Stone Double

C1257 - HO Scale (1 each)  
Outside: 8 1/16" x 5 1/4" - Inside: 4 3/4" x 3 7/8"  
C1157 - N Scale (2 each)  
Outside: 4" x 2 13/16" - Inside: 2 9/16" x 2"



**Lightweight Hydrocal C1201** **\$9.99**  
**Bulk C1201-B** **\$27.99**

A rock quarry in a box! Lightweight Hydrocal is half the weight of Hydrocal\* and specially formulated for terrain modeling. Mix according to instructions and pour into rock molds to create a limitless variety of rocks and formations. Also perfect for sculpting hard shell terrain and filling in around rocks and other castings. Available in two sizes.

1/2 gal./104 cu. in.  
 5 gal. (C1201-B)/1344 cu. in.

\*Hydrocal is a product of US Gypsum



**Rock Molds** 5" x 7" - **\$7.99**, 10 1/2" x 5" - **\$8.99**

Woodland Scenics Rock Molds are durable, flexible, reusable and well detailed. Use Lightweight Hydrocal to cast small boulders, rock outcroppings, rocks for fields and creeks or entire rock faces. Color with Earth Colors Liquid Pigment.

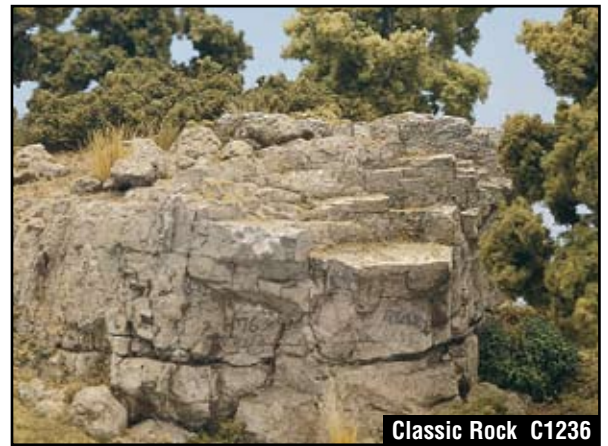

**Classic Rock C1236**



**Outcroppings**  
C1230 (5" x 7")



**Surface Rocks**  
C1231 (5" x 7")



**Boulders**  
C1232 (5" x 7")

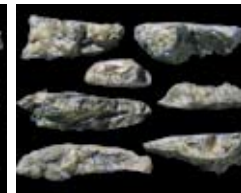

**Embankments**  
C1233 (5" x 7")



**Washed Rock**  
C1242 (10 1/2" x 5")



**Random Rock**  
C1234 (5" x 7")



**Laced Face Rock**  
C1235 (5" x 7")

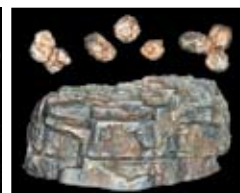

**Classic Rock**  
C1236 (5" x 7")



**Wind Rock**  
C1237 (5" x 7")



**Base Rock**  
C1243 (10 1/2" x 5")



**Weathered Rock**  
C1238 (5" x 7")



**Strata Stone**  
C1239 (5" x 7")



**Rock Mass**  
C1240 (5" x 7")



**Layered Rock**  
C1241 (5" x 7")



**Facet Rock**  
C1244 (10 1/2" x 5")



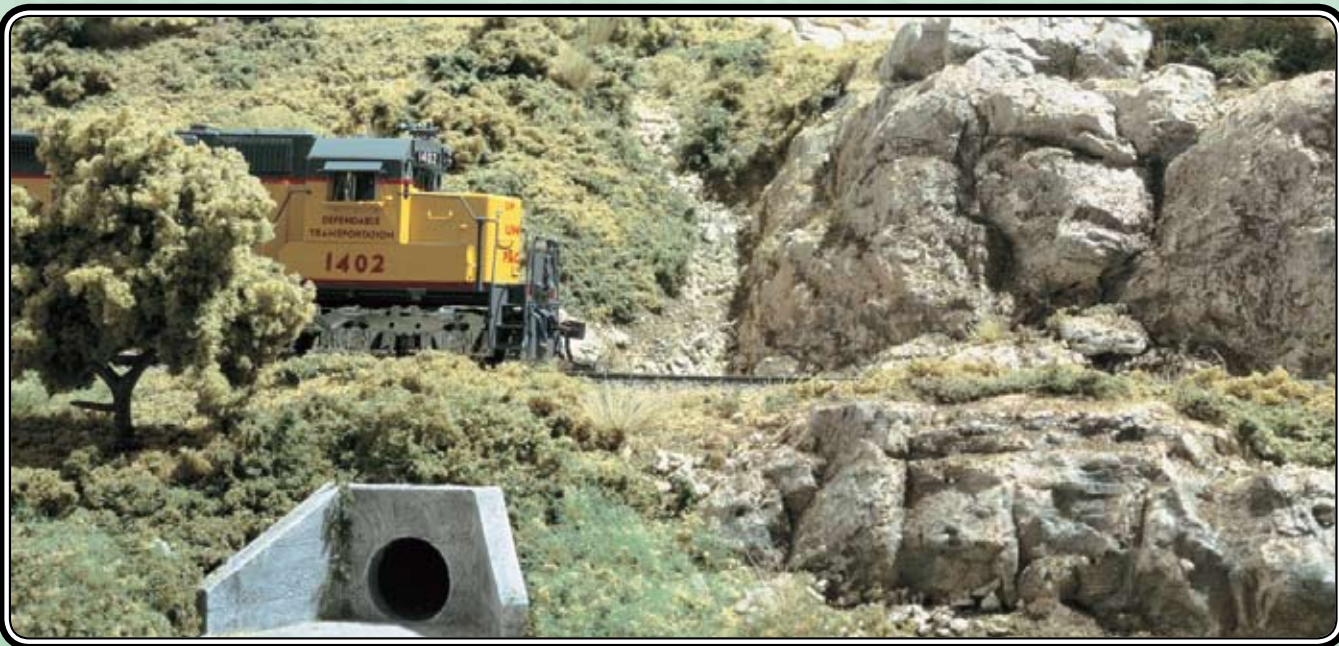

**Earth Colors Liquid Pigment™**

\$5.59

Use Earth Colors Liquid Pigment to color rocks, terrain and plaster castings. They are water-soluble and can be diluted and blended in limitless combinations. Extremely concentrated for economical usage. Available in eight colors. 4 fl. oz.

HOW-TO VIDEOS  
woodlandscenics.com



**White** C1216



**Concrete** C1217



**Stone Gray** C1218



**Slate Gray** C1219



**Black** C1220

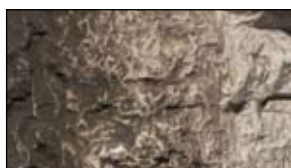

**Raw Umber** C1221



**Burnt Umber** C1222



**Yellow Ocher** C1223

**Earth Colors Liquid Pigment (Undercoat)**

\$7.49

Formulated for use under Blended Turf to provide a base color for terrain. Extremely concentrated. 8 fl. oz.



**Green Undercoat** C1228



**Earth Undercoat** C1229



**Earth Color Kit** C1215

\$19.99

This kit includes eight Earth Colors Liquid Pigment, applicator and palette. 1 fl. oz. ea.

HOW-TO VIDEOS  
woodlandscenics.com

- White • Concrete • Stone Gray • Slate Gray
- Black • Raw Umber • Burnt Umber • Yellow Ocher



Color swatches may vary from actual product.

## Tunnel Liner Form C1250 \$4.99

Cast realistic rock walls and ceilings for scale tunnels. This innovative mold is designed to form half of either a single or double liner section.  
*HO scale*



1. Use a spatula to fill the Tunnel Liner Form with Lightweight Hydrocal. When dry, remove from mold.



2. Join two half sections on top with a strip of wet Plaster Cloth to form a hinge.



3. Join completed units on one side for a longer tunnel. The unattached side can be raised for track maintenance.

## Latex Rubber C1204 \$14.99

Create long-lasting molds for rocks and other castings. Ready-to-use Latex Rubber is specifically formulated to be thin enough to seek detail and thick enough for durability. Easy and fast!  
*16 fl. oz.*



1. Brush three to six layers of Latex Rubber on rocks, hopper loads or other items.



2. Put gauze between each layer of Latex Rubber.



3. Allow each layer to dry between applications.



4. When completely dry, carefully pull off the mold.



5. Make castings with Lightweight Hydrocal.



6. Allow Hydrocal to dry thoroughly before removing from mold.

## Talus (Rock Debris) ⚠️

\$3.79

Where there is rock, there is rock debris. Debris piles up under rock faces, outcroppings and along side road cuts. Talus is a lightweight material made to model rock debris. Sprinkle some Talus on a layout and secure with a 50/50 mixture of Scenic Glue and water. For maximum realism, mix and blend grades and colors.  
*25 cu. in.*



### GRADES *Shown actual size*



Fine



Medium



Coarse



Extra Coarse

### COLORS



Buff



Brown

Fine	C1270
Medium	C1271
Coarse	C1272
Extra Coarse	C1273

Fine	C1274
Medium	C1275
Coarse	C1276
Extra Coarse	C1277

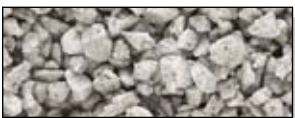

Gray



Natural

Fine	C1278
Medium	C1279
Coarse	C1280
Extra Coarse	C1281

Fine	C1282
Medium	C1283
Coarse	C1284
Extra Coarse	C1285

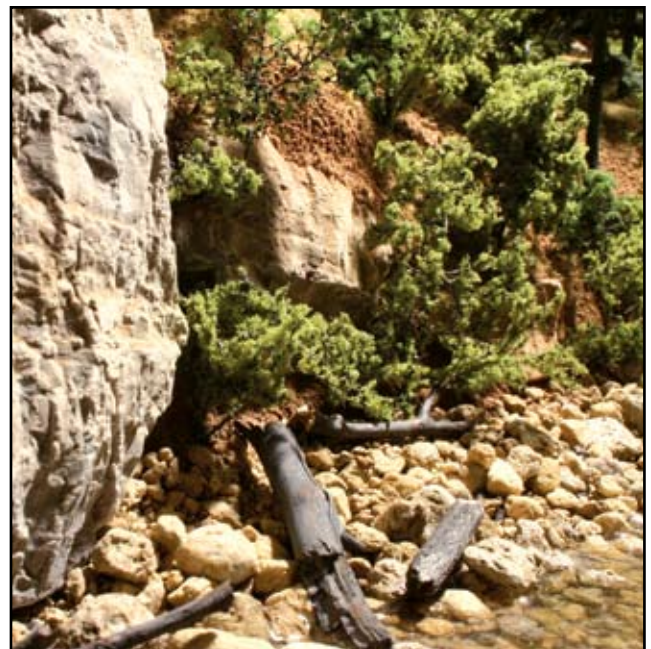

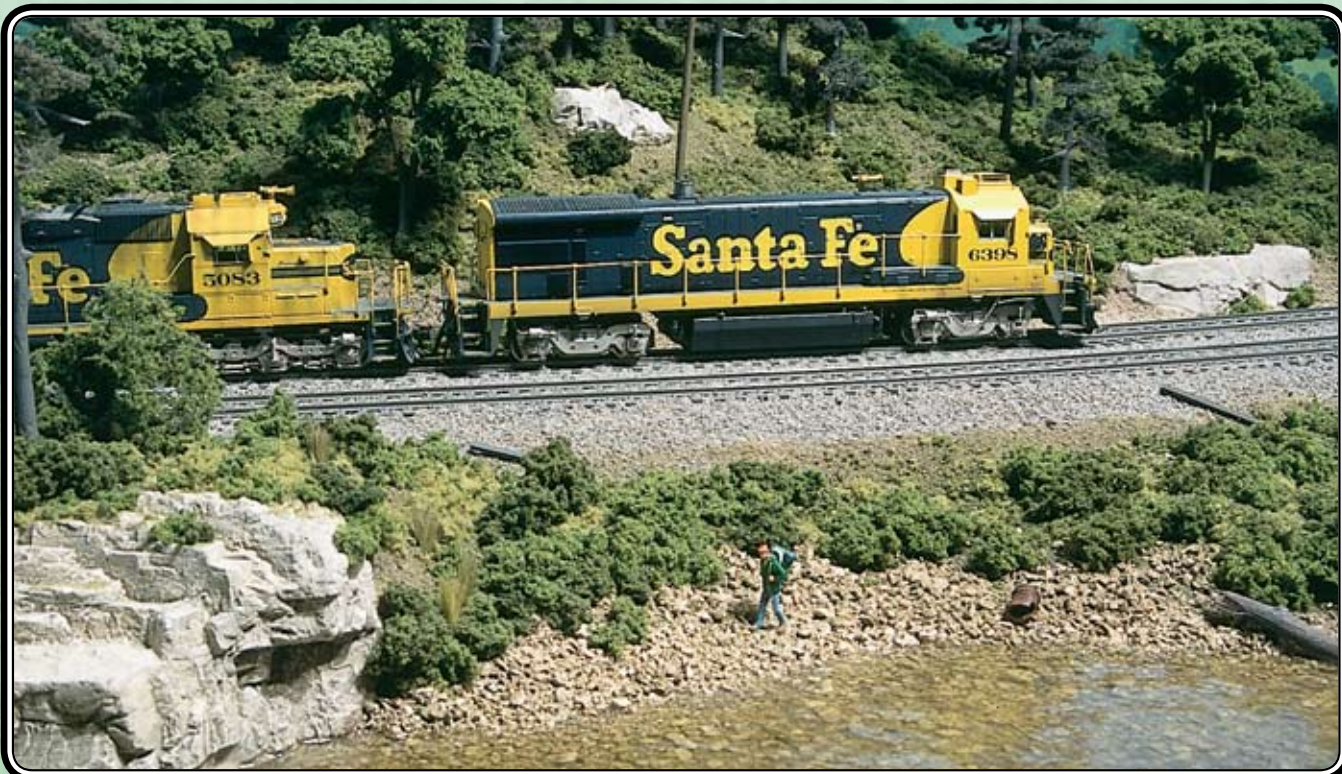

## Landscape System

Landscape adds depth, color, texture and realism to your layout. From ground cover and foliage to bushes and trees, the complete Landscape System offers versatile and compatible products. Developed to work together, landscape products mix and blend with each other to recreate nature's color variances, contrasts and highlights. Designed for ultimate realism, these easy-to-use products give beginner to advanced modelers the results they want and expect.

### ADHESIVES AND ACCESSORIES

#### Scenic Glue™ S190

**\$6.99**

Apply landscape materials with this specially-formulated, high-tack, non-odorous adhesive. Dries clear with a matte finish. Does not crack or turn yellow.

*8 fl. oz.*



#### Hob-e-Tac® Adhesive S195

**\$5.79**

This multi-purpose, water-soluble adhesive stays tacky. Use for making trees and attaching Field Grass to your layout. Apply Hob-e-Tac Adhesive, wait until clear and tacky, then attach foliage products.

*2 fl. oz.*



#### Scenic Cement™ S191

**\$6.99**

Scenic Cement now has a smooth, flowing application that reduces spray head clogging, foaming and bubbles. There is no need to use "wet water," and the new formula penetrates easier and faster. It actually wraps around the product and permeates instantly for maximum coverage. It is especially great for sealing Forest Canopy material and attaching Fine, Blended and Coarse Turfs, Static Grass Flock, Poly Fiber, Ballast, Flowering Foliage and other foliage. Use with Scenic Sprayer.

*16 fl. oz.*



#### Scenic Sprayer™ S192

**\$4.29**

The Scenic Sprayer comes with a siphon tube and spray head that fits the Scenic Cement bottle. The nozzle adjusts from a fine mist to a steady stream. Measurement markings in ounces and milliliters are on the side. Use with Scenic Cement, Earth Colors Liquid Pigment and other liquids.

*Holds 8 oz.*



#### Canister Shaker S194

**\$4.29**

This Canister Shaker is perfect for storing all landscape products. It comes with a dual-purpose cap: one side is a shaker and the other pours large amounts. Includes a blank identification label.

*Holds 32 oz.*



#### Canister Shaker Set S199

**\$21.99**

Organize and store your landscape products with a set of Canister Shakers and sturdy cardboard container, which can be hung on pegboard or set on your workbench. They come with six blank labels to identify the stored products.

*Each Shaker holds 32 oz.*



This warning applies to all products on this page.  **WARNING:** Choking Hazard! Small parts. Not intended for children under 3 yrs.

**Fine Turf** Bag - \$3.79, Shaker - \$10.29

Fine Turf adds texture and highlights to trees and scenery. It is available in six realistic colors, which model fresh, scorched and dying grasses, weeds and dirt roads. Attach with Scenic Cement.

Bag 18 cu. in./Shaker 50 cu. in.



particle approx. 1/1000"-1/32"



**Soil**  
T41 (Bag)  
T1341 (Shaker)



**Earth**  
T42 (Bag)  
T1342 (Shaker)



**Yellow Grass**  
T43 (Bag)  
T1343 (Shaker)



**Burnt Grass**  
T44 (Bag)  
T1344 (Shaker)



**Green Grass**  
T45 (Bag)  
T1345 (Shaker)



**Weeds**  
T46 (Bag)  
T1346 (Shaker)

**Blended Turf** Bag - \$7.49, Shaker - \$10.29

Use Blended Turf as a base covering over Earth Colors Undercoat Pigment to model grass, weeds and other low growing plants. It is available in two colors. Attach with Scenic Cement.

Bag 54 cu. in./Shaker 50 cu. in.



**Green Blend**  
T49 (Bag)  
T1349 (Shaker)



**Earth Blend**  
T50 (Bag)  
T1350 (Shaker)

**Coarse Turf** Bag - \$3.79, Shaker - \$10.29

Coarse Turf models low grasses, leaves, weeds and adds texture and highlights to trees and scenery. It provides a smooth transition from low to medium and high ground cover, and is available in 11 natural colors. Attach with Scenic Cement.

Bag 18 cu. in./Shaker 50 cu. in.



particle approx. 1/32"-1/8"



**Earth**  
T60 (Bag)



**Yellow Grass**  
T61 (Bag)  
T1361 (Shaker)



**Burnt Grass**  
T62 (Bag)  
T1362 (Shaker)



**Light Green**  
T63 (Bag)  
T1363 (Shaker)



**Medium Green**  
T64 (Bag)  
T1364 (Shaker)



**Dark Green**  
T65 (Bag)  
T1365 (Shaker)



**Conifer**  
T1366 (Shaker)



**Fall Yellow**  
T1353 (Shaker)



**Fall Orange**  
T1354 (Shaker)



**Fall Red**  
T1355 (Shaker)



**Fall Rust**  
T1356 (Shaker)

This warning applies to all products on this page. **WARNING: Choking Hazard! Small parts. Not intended for children under 3 yrs.**

**Underbrush** Bag - \$4.79, Shaker - \$12.99  
 Underbrush models low to medium ground cover, and is the perfect product for making small to medium trees. It is available in six colors for realistic bushes, trees and shrubs. Attach to Tree Armatures with Hob-e-Tac Adhesive. Use Scenic Glue to attach to layout.  
 Bag 18 cu. in./Shaker 50 cu. in.



Patented Product



particle approx. 1/8"-5/16"



**Olive Green** FC134 (Bag) FC1634 (Shaker)  
**Light Green** FC135 (Bag) FC1635 (Shaker)  
**Medium Green** FC136 (Bag) FC1636 (Shaker)



**Dark Green** FC137 (Bag) FC1637 (Shaker)  
**Forest Green** FC138 (Bag) FC1638 (Shaker)  
**Forest Blend** FC139 (Bag) FC1639 (Shaker)

**Bushes** Bag - \$4.79, Shaker - \$12.99  
 Bushes models medium to high ground cover, such as bushes, shrubs and trees, and is the perfect product for making medium to large trees. It is available in six realistic colors. Attach to Tree Armatures with Hob-e-Tac Adhesive. Use Scenic Glue to attach to layout.  
 Bag 18 cu. in./Shaker 50 cu. in.



Patented Product



particle approx. 5/16"-1/2"



**Olive Green** FC144 (Bag) FC1644 (Shaker)  
**Light Green** FC145 (Bag) FC1645 (Shaker)  
**Medium Green** FC146 (Bag) FC1646 (Shaker)



**Dark Green** FC147 (Bag) FC1647 (Shaker)  
**Forest Green** FC148 (Bag) FC1648 (Shaker)  
**Forest Blend** FC149 (Bag) FC1649 (Shaker)

**Static Grass Flock™** \$10.99

Static Grass Flock is a fiber product that models grass or weeds on any layout. It is available in six colors and can be used alone, or with Fine Turf. Place under trees or along ditches. It can also be used as forest litter. Use Scenic Cement to attach to layout.  
 Shaker 50 cu. in.



**Wild Honey** FL631 **Harvest Gold** FL632 **Burnt Grass** FL633



**Light Green** FL634 **Medium Green** FL635 **Dark Green** FL636



Color swatches may vary from actual product.

This warning applies to all products on this page.  **WARNING:** Choking Hazard! Small parts. Not intended for children under 3 yrs.

## Clump-Foliage™ 1 qt. - \$6.49, 3 qt. - \$15.99

Clump-Foliage models medium to high ground cover. It is great for landscaping hillsides. Create shrubs, bushes and trees with five colors and a fall mix. Attach to Tree Armatures with Hob-e-Tac Adhesive. Attach to layout with Scenic Glue.  
 Small Bag 55 cu. in. (1 qt.)  
 Large Bag 165 cu. in. (3 qt.)



particle approx. 1/8"-1 1/2"



**Burnt Grass**  
FC181 (Large Bag)



**Light Green**  
FC682 (Small Bag)  
FC182 (Large Bag)



**Medium Green**  
FC683 (Small Bag)  
FC183 (Large Bag)



**Dark Green**  
FC684 (Small Bag)  
FC184 (Large Bag)



**Conifer Green**  
FC185 (Large Bag)

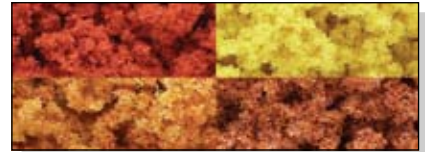

**Fall Mix**  
FC186 (Large Bag)

## Foliage Clusters™

\$8.99

Break Foliage Clusters into any size and use to model bushes, shrubs and trees or high ground cover. Use on hillsides to model tree masses. Attach to layout with Scenic Glue.  
 Bag 45 cu. in.

Patented Product



particle approx. 1 1/2"-3"



**Light Green** FC57



**Medium Green** FC58



**Dark Green** FC59

## Landscape Steps

Refer to page 5 for the Landscaping Learning Kit (LK954).



1. Paint layout (or model) with Earth Colors and spray with Scenic Cement.



2. Sprinkle on a base layer of Blended Turf.



3. Lightly spray with Scenic Cement to fix in place.



4. Add more color and texture with Fine and Coarse Turf in various colors and sizes.



5. Use Scenic Glue to attach Underbrush, Bushes, Forest Canopy, Clump-Foliage and Foliage Clusters.



6. Allow to dry thoroughly and spray again with Scenic Cement to fix in place.

Color swatches may vary from actual product.

This warning applies to all products on this page. **WARNING:** Choking Hazard! Small parts. Not intended for children under 3 yrs.

**Lichen** 1.5 qt. - \$8.99, 3 qt. - \$14.99

A longtime favorite of hobbyists, this uniquely textured natural product blends easily with other foliage to create realistic scenery. Lichen models bushes and ground cover, or use as tree foliage. It is available in five solid colors and three mixes, designed to blend with our other landscape products. Use Lichen for quick and economical tree masses on your layout. Attach to Tree Armatures with Hob-e-Tac Adhesive. Use Scenic Glue to attach to layout. *Small Bag 82 cu. in. (1.5 qt.)/Large Bag 165 cu. in. (3 qt.)*



**Spring Green**  
L161 (Small Bag)



**Light Green**  
L162 (Small Bag)



**Medium Green**  
L163 (Small Bag)



**Dark Green**  
L164 (Small Bag)



**Autumn Mix**  
L165 (Small Bag)



**Natural**  
L166 (Small Bag)



**Light Green Mix**  
L167 (Large Bag)



**Dark Green Mix**  
L168 (Large Bag)



1. Select a piece of Lichen in the desired shape and size.



2. Spray with Scenic Cement.



3. Lightly sprinkle on Fine or Coarse Turf to add realistic color and texture.

**Field Grass** \$3.79

Field Grass is an extremely fine, natural hair product that models tall grass, field grass and weeds. Four realistic colors. Attach with Hob-e-Tac Adhesive or Scenic Glue. *8 gr. (Coverage area depends on usage)*



**Natural Straw**  
FG171



**Harvest Gold**  
FG172



**Light Green**  
FG173



**Medium Green**  
FG174



1. Cut Field Grass.



2. Dip into Hob-e-Tac Adhesive or Scenic Glue.



3. Place on layout.



4. Dry thoroughly.

Color swatches may vary from actual product.

This warning applies to all products on this page.  **WARNING:** Choking Hazard! Small parts. Not intended for children under 3 yrs.

**Foliage**

**\$4.79**

Foliage is excellent for making trees, vines, weeds, bushes or any low growth. Simply stretch the sheet of Foliage for a thin, lacy application. Attach Foliage with Scenic Cement. Create quick and economical tree masses on your layout. Stretch Foliage to desired density, then roll into a loose ball. Stretch the ball into a conical shape for variation. Attach to hillsides with Scenic Glue. Foliage is available in four colors and two fall blends. 60 sq. in.



**Light Green** F51



**Medium Green** F52



**Dark Green** F53



**Conifer Green** F54

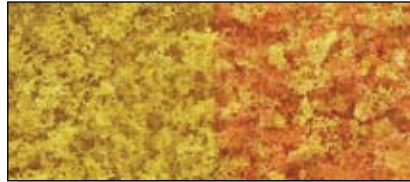

**Early Fall** F55



**Late Fall** F56



1. Stretch and tear Foliage until thin and lacy.



2. Attach to Tree Armatures.



3. Attach to Tunnel Portals, buildings and bridges.

**Poly Fiber** FP178

**\$3.29**

Poly Fiber is synthetic fiber used to create vines, undergrowth and other rambling vegetation. Apply it on the sides of buildings, Tunnel Portals, Retaining Walls, light poles, billboards and along fence rows, or other places you see vines grow. Use Poly Fiber after you add ground covers and set buildings on your layout. Great for quick and economical tree masses on your layout. Attach to layout with Scenic Cement. 16 gr./.56 oz. (Coverage area depends on usage)



**Green**





This warning applies to all products on this page.  **WARNING: Choking Hazard! Small parts. Not intended for children under 3 yrs.**

**Flowering Foliage™** **\$3.59**

Use Flowering Foliage to add color and model flowers along railroad tracks, in fields, on hills or around buildings. Place on layout and attach with Scenic Cement.

*Covers approximately 100 sq. in.*



**Yellow** F176



**Purple** F177









**Fruit and Flowers** **\$3.99**

To model apple and orange trees, sprinkle Fruit on small trees. Model flowering plants by sprinkling Flowers on small bushes, shrubs, vines and fields. Attach with Scenic Cement.

*1 1/2 cu. in. per pkg.*

**Fruit** T47 (Apples and Oranges)  
**Flowers** T48 (4 colors: red, yellow, white and orange)



**Dead Fall** S30 **\$4.49**

Dead Fall is a natural, realistic product, which has the look of aged wood and is used to model fallen or standing dead trees and stumps. Use this assortment of wood pieces on any scale layout. Pieces feature gnarled branches, knots and some are smooth, with signs of weathering. Attach with Scenic Glue.

*.5 oz.*







**Stumps** **\$5.99**

Add realistic detail to wooded or deforested areas on your layout with Cut or Broken Stumps. Clean parts, paint and adhere to layout with Scenic Glue.

*14 pcs. per package*

**Cut Stumps** S31  
**Broken Stumps** S32





**Soft Flake Snow™** SN140 **\$10.99**

For the ultimate realism in winter scenes, use Soft Flake Snow for any layout or project. For a dusting of snow, sprinkle and attach with Scenic Cement. For heavy drifts, apply Flex Paste (page 9) to your layout and sprinkle Snow on top.

*50 cu. in.*



Color swatches may vary from actual product.



## Realistic Water™ C1211 \$19.99

This no-mix formula models beautiful, realistic water areas, such as lakes, ponds, rivers and more! The surface dries hard and clear, with minimal shrinkage, and the formula is water-soluble and non-toxic. Realistic Water will not crack and is self-healing. Pour no more than 1/8" deep at a time and allow to dry thoroughly between layers (about 24 hours). The contents cover approximately 17" diameter area when poured to the recommended depth of 1/8". 16 fl. oz./434 ml.

Refer to page 5 for the River/Waterfall Learning Kit (LK955).



## Water Effects™ C1212 \$14.99

Water Effects is a heavy-bodied product, which is moldable and will hold its shape. Create pond ripples, waterfalls or rapidly moving water. It dries clear in about 24 hours. 8 fl. oz. (Coverage area depends on usage). Refer to page 5 for the River/Waterfall Learning Kit (LK955).



1. Apply Water Effects onto a non-stick surface.



2. Shape and texture with a toothpick to create desired effect.



3. When dry, peel off and place on layout.



4. Attach with Water Effects.

## E-Z Water™ C1206 \$10.99

E-Z Water is a heat-activated product used for modeling various bodies of water. It dries quickly. Re-heat with a heat gun to remove scratches or to mold various accents, such as ripples, waves and rapids. 28 cu. in.



1. Melt E-Z Water pellets over medium heat.



2. Pour into prepared areas.

## Ready Landforms

These Ready Landforms are pre-formed and durable. Because they are already landscaped, they easily blend with any layout. Just set and go! Their portability makes them ideal for gaming. Ready Landforms also stack for space-saving storage. Tunnels and Rocky Ridges are the perfect complements to ReadyGrass Vinyl Mats.



**Tunnels** are available in both N and HO scales, straight or curved designs and have molded-in portals at each end.

**Rocky Ridges** are available in two sizes and are perfect to place as road cut or a rocky embankment.



**HO Straight Tunnel C1310** **\$21.99**  
 (26" w x 16 1/2" d x 8" h, portal opening 2 3/4" w x 3 5/8" h, 18" radius)



**N Straight Tunnel C1315** **\$14.99**  
 (14 1/2" w x 9 1/2" d x 5" h, portal opening 1 3/8" w x 1 3/4" h, 11" radius)



**HO Curved Tunnel C1311** **\$21.99**  
 (25 3/4" w x 15 1/2" d x 8" h, portal opening 2 3/4" w x 3 5/8" h, 18" radius)



**N Curved Tunnel C1316** **\$14.99**  
 (16 1/2" w x 10" d x 5" h, portal opening 1 3/8" w x 1 3/4" h, 11" radius)



**Rocky Ridge Large C1320** **\$14.99**  
 (25" L x 9" w x 3 1/2" h)



**Rocky Ridge Small C1321** **\$12.99**  
 (14 1/2" L x 6" w x 1 3/4" h)

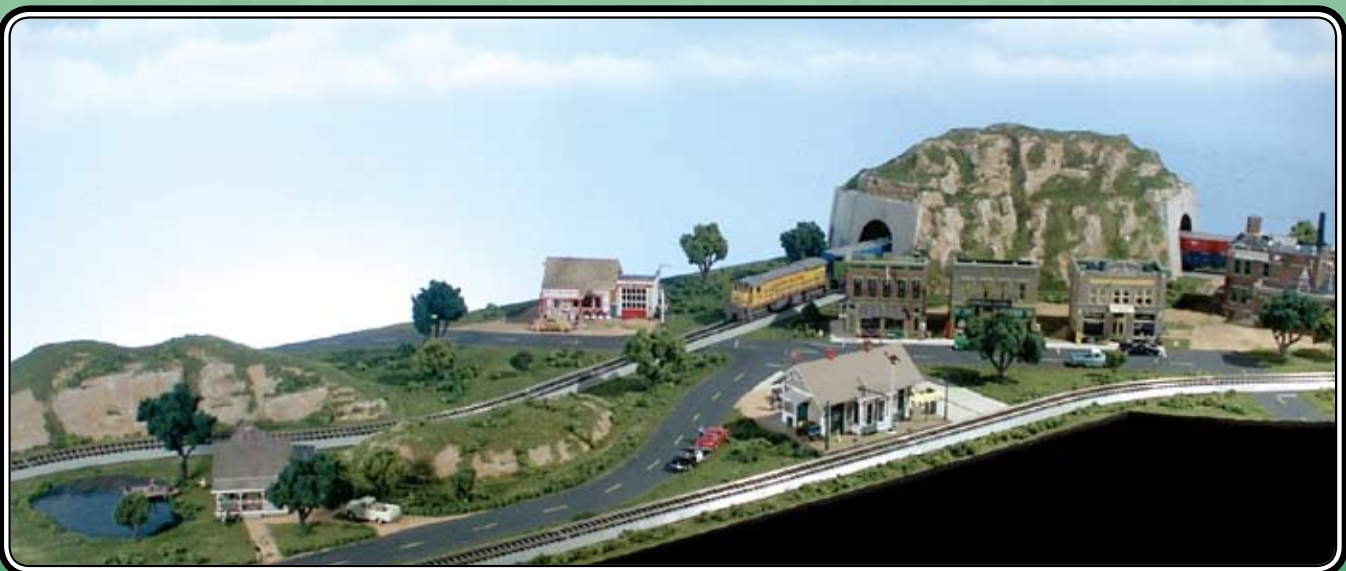

# ReadyGrass Vinyl Mat



Its unique characteristics make this non-shedding, vinyl grass mat the best on the market! They are ideal for train layouts, battle mats, architectural models, school projects, arts and crafts, slot cars, collectible houses, military models and more! Use a heat tool to form a hill, mound or valley, or simply scrape to create space for roads and water areas. Permanently mount the ReadyGrass Vinyl Mat to your layout or roll it up and use it again and again! Four resistant colors available in three roll sizes - 50 x 100-inch, 33 x 50-inch and 33 x 25-inch). Also available in Project Sheet size (12 1/2 x 14 1/8-inch).

- **Moldable and retains its shape...**for making hills
- **Removable Turf...**for making roads and water areas
- **Durable/tear resistant...**use again and again
- **Non-shedding/non-staining...**no mess
- **Colorfast...**no fading

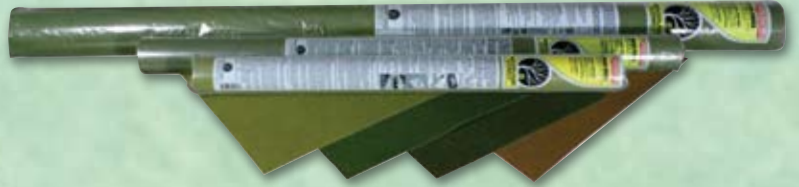

50" x 100" - \$28.99, 33" x 50" - \$11.99, 33" x 25" - \$9.99, Project Sheet 12 1/2" x 14 1/8" - \$3.29

Patent Pending



### Spring Grass

50" x 100"	RG5121
33" x 50"	RG5131
33" x 25"	RG5171
12 1/2" x 14 1/8"	RG5141



### Green Grass

50" x 100"	RG5122
33" x 50"	RG5132
33" x 25"	RG5172
12 1/2" x 14 1/8"	RG5142



### Forest Grass

50" x 100"	RG5123
33" x 50"	RG5133
33" x 25"	RG5173
12 1/2" x 14 1/8"	RG5143



### Summer Grass

50" x 100"	RG5124
33" x 50"	RG5134
33" x 25"	RG5174
12 1/2" x 14 1/8"	RG5144



Model Railroading



Gaming



Dioramas & School Projects



Collectible Houses

# ReadyGrass® Vinyl Mat Accessories

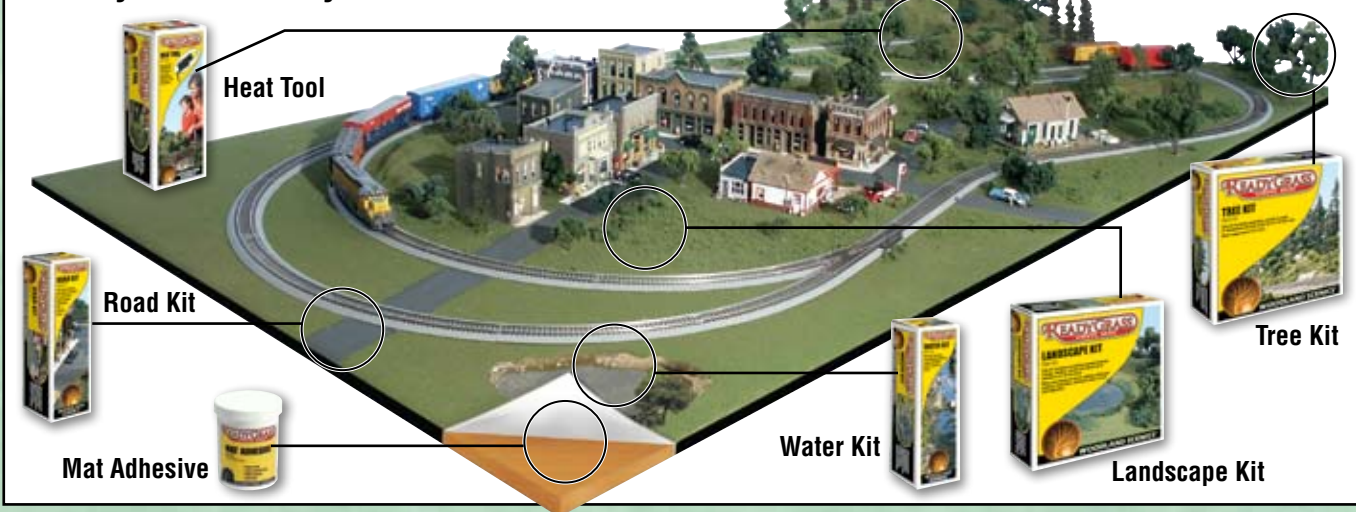

**Road Kit** RG5151  **\$11.99**

This kit includes everything needed to create and detail roads, sidewalks and parking areas.



1. Wet area for road/parking areas. Remove turf with Road Scraper, then paint.



2. Detail road/parking areas with Striping Pin.

**HOW-TO VIDEOS**  
woodlandscenics.com

**Landscape Kit** RG5152  **\$15.99**

This kit includes everything needed (various foliage, bushes, shrubs and adhesive) to enhance a 4 x 8-foot area. Add paths, different colors of turf and highlights. Refer to page 22 for Landscape Steps.



1. Spray adhesive on area to be landscaped.



2. Add bushes and shrubs. Blend and add low ground cover.

**HOW-TO VIDEOS**  
woodlandscenics.com

**Water Kit** RG5153  **\$11.99**

This kit includes everything needed to create streams, rivers, ponds and lakes. Covers a 32 sq. in. area.



1. Wet water area. Remove turf with Scraper, then paint.



2. Pour or brush on Realistic Water.

**HOW-TO VIDEOS**  
woodlandscenics.com

**Tree Kit** RG5154  **\$21.99**

This kit includes everything needed to make 27 deciduous and pine trees for a 4 x 8-foot area. Sizes range from 2 1/2 to 6-inches.



1. Twist armature into tree shape.



2. Apply adhesive and dip in foliage.



3. Plant trees on layout.

**HOW-TO VIDEOS**  
woodlandscenics.com

**Mat Adhesive** RG5161 **\$7.49**

Use Mat Adhesive for permanently bonding mats to any clean, smooth surface. Great for mounting puzzles and posters to art board.  
7 fl. oz.



Apply Mat Adhesive. Press onto surface.

**Heat Tool** RG5162 **\$29.99**

Use with ReadyGrass Vinyl Mats to form hills and mounds.

**HOW-TO VIDEOS**  
woodlandscenics.com

**International Heat Tools** **\$31.99**

- 230V Heat Tool**..... RG5163 (Transformer/Plug Europe)
- 240V Heat Tool**..... RG5164 (Transformer/Plug UK)
- 230V or 240V Heat Tool**.. RG5165 (Transformer/Plug Australia/New Zealand)



Form hills over newspaper wads with Heat Tool.



This warning applies to all products on this page.



**WARNING:** Choking Hazard! Small parts. Not intended for children under 3 yrs.

## Premium Trees™

These Premium Trees are hand-crafted works of art that replicate real trees. The design of the branch and leaf structure easily identifies the tree type. The tree trunks are textured to look like real bark. Each tree has a planting base pin. There are three different package sizes with trees ranging from 1 1/2" to 6". All heights are approximate.



**Sweetgum TR1608**  
4" (1 pkg.)

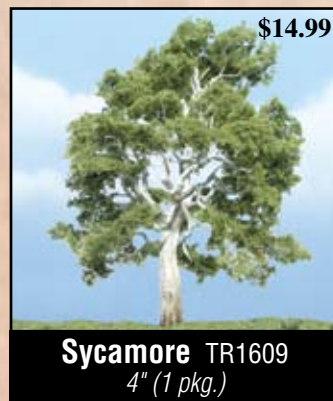

**Sycamore TR1609**  
4" (1 pkg.)



**Maple TR1610**  
4 1/2" (1 pkg.)



**Poplar TR1611**  
4 1/2", 3 1/2", 4" (3 pkg.)



**Fall Beech TR1613**  
4" (1 pkg.)

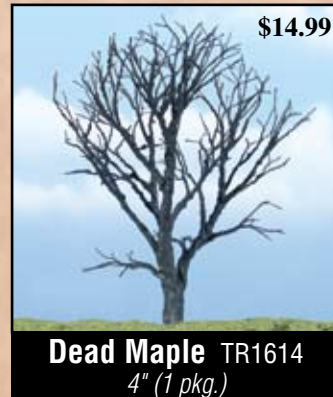

**Dead Maple TR1614**  
4" (1 pkg.)



**Beech TR1615**  
4" (1 pkg.)



**Paper Birch TR1616**  
4" (1 pkg.)



**Royal Palm TR1617**  
4 1/2", 3", 4" (3 pkg.)



**Basswood TR1618**  
4" (1 pkg.)



**Birch TR1601**  
4" (1 pkg.)



**Dead Elm TR1602**  
3 1/4", 2 1/4" (2 pkg.)



**Sycamore TR1603**  
3", 2 1/4" (2 pkg.)



**Fall Maple TR1604**  
3 1/4", 2 3/8" (2 pkg.)



**Paper Birch TR1605**  
2 3/4", 1 1/2", 2 1/4" (3 pkg.)



**Oak TR1606**  
3" (1 pkg.)



**Locust TR1607**  
3", 1 3/4" (2 pkg.)



**Aspen TR1612**  
2 3/4", 2 1/4" (2 pkg.)

See page 138 for merchandiser. Color may vary from actual product.

Trees

This warning applies to all products on this page.  **WARNING:** Choking Hazard! Small parts. Not intended for children under 3 yrs.



\$19.99

**Juniper** TR1619  
5", 2 1/2", 3" (3 pkg.)



\$19.99

**Oak** TR1620  
5" (1 pkg.)



\$18.99

**Spruce** TR1621  
5", 4" (2 pkg.)



\$19.99

**Walnut** TR1622  
4" (1 pkg.)



\$19.99

**Hickory** TR1623  
5 3/8" (1 pkg.)



\$18.99

**Pine** TR1624  
5 1/4", 4" (2 pkg.)



\$8.99

**Conifer** TR1625  
3", 4" (2 pkg.)



\$17.99

**Lodgepole** TR1627  
4", 5" (2 pkg.)



\$9.99

**Evergreen** TR1626  
4", 5" (2 pkg.)



\$19.99

**Lodgepole** TR1628  
5", 6" (2 pkg.)



Trees

This warning applies to all products on this page.



**WARNING:** Choking Hazard! Small parts. Not intended for children under 3 yrs.

**NEW**

## Woodland Classics™

Woodland Classics ready-made trees are handcrafted with classic appeal and economically priced. Their finely detailed, hand-painted tree trunks represent a multitude of realistic shapes and branching forms. Our original patented foliage is applied by hand, yielding a variety of natural foliage variances.

In every detail, Woodland Classics mirror nature's contrasts and highlights: reinforcing the trademark mixing and blending of our Landscape System. Use combinations of types and sizes throughout your layout for superior realism.

Pictures are representative: actual trees will vary in size and shape. No two trees are alike within one package.



Optional bases included.





This warning applies to all products on this page.



**WARNING:** Choking Hazard! Small parts. Not intended for children under 3 yrs.



**Early Light**

Featuring the bright, light green of an early dawn

**Sun Kissed**

Medium green foliage shimmers in a high-noon sun

**Cool Shade**

Dark green foliage offers a cool, shady retreat

**Waters Edge**

Patterned light-colored bark wraps this thirsty beauty



**Blue Needle**

Magnificent blue-green tinge amidst graceful symmetry

**Forever Green**

Strong and handsome silhouette with dark dense foliage

**Standing Timber**

Straight and towering guardian of the forest

**Snow Dusted**

Strong graceful branches crisp with fresh-fallen flakes



**Harvest Blaze**

Scarlet and golden reminders of autumn's pending retirement

**Hedge Row**

A stately boundary stakes its claim and calms the wind

Early Light	QTY.	ITEM #
3/4" - 1 1/4"	8/pkg	TR3545
1 1/4" - 2"	5/pkg	TR3546
2" - 3"	4/pkg	TR3503
3" - 4"	3/pkg	TR3506
4" - 5"	3/pkg	TR3509
5" - 6"	2/pkg	TR3512

Blue Needle	QTY.	ITEM #
2 1/2" - 4"	5/pkg	TR3566
4" - 6"	4/pkg	TR3569

Harvest Blaze	QTY.	ITEM #
1 1/4" - 3"	9/pkg	TR3540
3" - 5"	6/pkg	TR3541

Sun Kissed	QTY.	ITEM #
3/4" - 1 1/4"	8/pkg	TR3501
1 1/4" - 2"	5/pkg	TR3502
2" - 3"	4/pkg	TR3504
3" - 4"	3/pkg	TR3507
4" - 5"	3/pkg	TR3510
5" - 6"	2/pkg	TR3513
6" - 7"	2/pkg	TR3516
7" - 8"	2/pkg	TR3518

Forever Green	QTY.	ITEM #
2 1/2" - 4"	5/pkg	TR3565
4" - 6"	4/pkg	TR3568
7" - 8"	3/pkg	TR3573

Cool Shade	QTY.	ITEM #
3/4" - 1 1/4"	8/pkg	TR3547
1 1/4" - 2"	5/pkg	TR3548
2" - 3"	4/pkg	TR3505
3" - 4"	3/pkg	TR3508
4" - 5"	3/pkg	TR3511
5" - 6"	2/pkg	TR3514
6" - 7"	2/pkg	TR3517
8" - 9"	2/pkg	TR3521

Standing Timber	QTY.	ITEM #
2 1/2" - 4"	5/pkg	TR3560
4" - 6"	4/pkg	TR3561
6" - 7"	3/pkg.	TR3562
7" - 8"	3/pkg.	TR3563

Waters Edge	QTY.	ITEM #
3/4" - 1 1/4"	8/pkg	TR3531
1 1/4" - 2"	5/pkg	TR3532
2" - 3"	4/pkg	TR3533
3" - 4"	3/pkg	TR3534
4" - 5"	3/pkg	TR3535
5" - 6"	2/pkg	TR3536
6" - 7"	2/pkg	TR3537
7" - 8"	2/pkg	TR3538
8" - 9"	2/pkg	TR3539

Snow Dusted	QTY.	ITEM #
2 1/2" - 4"	5/pkg	TR3567

Hedge Row	QTY.	ITEM #
1" - 2" w x 7 3/4" h	1/pkg	TR3581
1" - 4" w x 8 1/4" h	1/pkg	TR3582

This warning applies to all products on this page.  **WARNING:** Choking Hazard! Small parts. Not intended for children under 3 yrs.



## Ready Made Realistic Trees™

These trees lend authenticity to any layout or diorama. Their natural colors and realistic textures blend with other Woodland Scenics landscape products. Plant trees in clusters and intermix foliage colors. For more detail, spray foliage with Scenic Cement and highlight with Fine Turf. Attach to layout with Hob-e-Tac Adhesive or Scenic Glue. Detachable bases included.



*Made with patented products.*



**Light Green**



**Medium Green**

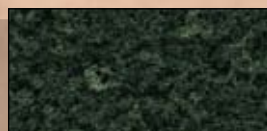

**Dark Green**



**Fall Mix**



**Conifer Green**



**\$8.99**

**Conifer Green TR1560**  
2 1/2" - 4" (5 pkg.)

**N SCALE:** 33' - 53'

**HO SCALE:** 18' - 29'

**O SCALE:** 10' - 16'



**\$8.99**

**Conifer Green TR1561**  
4" - 6" (4 pkg.)

**N SCALE:** 53' - 80'

**HO SCALE:** 29' - 44'

**O SCALE:** 16' - 24'



**\$10.49**

**Conifer Green TR1562**  
6" - 7" (3 pkg.)

**HO SCALE:** 44' - 51'

**O SCALE:** 24' - 28'



**\$12.49**

**Conifer Green TR1563**  
7" - 8" (3 pkg.)

**HO SCALE:** 51' - 58'

**O SCALE:** 28' - 32'

See page 138 for merchandiser. Color swatches may vary from actual product.

Trees

This warning applies to all products on this page.



**WARNING:** Choking Hazard! Small parts. Not intended for children under 3 yrs.

**\$7.99**

**Medium Green** TR1501  
*3/4" - 1 1/4" (8 pkg.)*

**N SCALE:** 10' - 17'     **HO SCALE:** 5' - 9'     **O SCALE:** 3' - 5'

**\$7.99**

**Medium Green** TR1502  
*1 1/4" - 2" (5 pkg.)*

**N SCALE:** 17' - 27'     **HO SCALE:** 9' - 15'     **O SCALE:** 5' - 8'

**\$8.49**

**Light Green** TR1503     **Medium Green** TR1504     **Dark Green** TR1505  
*2" - 3" (4 pkg.)*

**N SCALE:** 27' - 40'     **HO SCALE:** 15' - 22'     **O SCALE:** 8' - 12'

**\$9.99**

**Light Green** TR1506     **Medium Green** TR1507     **Dark Green** TR1508  
*3" - 4" (3 pkg.)*

**N SCALE:** 40' - 53'     **HO SCALE:** 22' - 29'     **O SCALE:** 12' - 16'

**\$10.99**

**Light Green** TR1509     **Medium Green** TR1510     **Dark Green** TR1511  
*4" - 5" (3 pkg.)*

**N SCALE:** 53' - 67'     **HO SCALE:** 29' - 36'     **O SCALE:** 16' - 20'

**\$10.99**

**Light Green** TR1512     **Medium Green** TR1513     **Dark Green** TR1514  
*5" - 6" (2 pkg.)*

**N SCALE:** 67' - 80'     **HO SCALE:** 36' - 44'     **O SCALE:** 20' - 24'

**\$14.99**

**Light Green** TR1515     **Medium Green** TR1516     **Dark Green** TR1517  
*6" - 7" (2 pkg.)*

**N SCALE:** 80' - 93'     **HO SCALE:** 44' - 51'     **O SCALE:** 24' - 28'

**\$16.99**

**Medium Green** TR1518  
*7" - 8" (2 pkg.)*

**N SCALE:** 93' - 106'     **HO SCALE:** 51' - 58'     **O SCALE:** 28' - 32'

**\$18.99**

**Medium Green** TR1519  
*8" - 9" (2 pkg.)*

**N SCALE:** 106' - 119'     **HO SCALE:** 58' - 65'     **O SCALE:** 32' - 36'

**\$16.99**

**Fall Mix** TR1540  
*1 1/4" - 3" (9 pkg.)*

**N SCALE:** 17' - 40'     **HO SCALE:** 9' - 22'     **O SCALE:** 5' - 12'

**\$19.99**

**Fall Mix** TR1541  
*3" - 5" (6 pkg.)*

**N SCALE:** 40' - 67'     **HO SCALE:** 22' - 36'     **O SCALE:** 12' - 20'

This warning applies to all products on this page.



**WARNING:** Choking Hazard! Small parts. Not intended for children under 3 yrs.

## Ready Made Trees™ Value Pack

**\$29.99**

Value Packs offer the best value in a ready-made tree and are the quickest way to add trees to a layout. Use the included base for temporary placement, or attach permanently with Hob-e-Tac Adhesive or Scenic Glue.

Made with patented products.



**Mixed Green Colors**



**Fall Colors**



**Conifer Colors**



**Evergreen Blend**



**Blue Spruce**



**Mixed Green Deciduous**



**Fall Colors Deciduous**

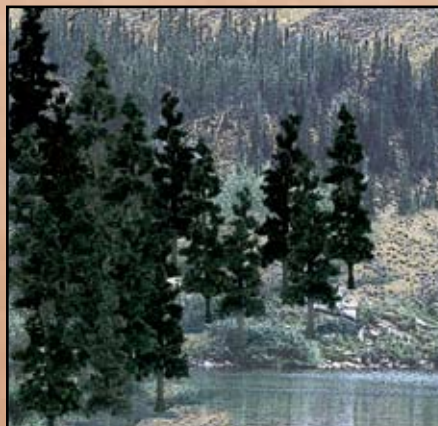

**Conifer Color Pine**



**Evergreen Blend Fir**



**Blue Spruce**

<b>Mixed Green Deciduous</b>	<b>QTY.</b>	<b>ITEM #</b>
3/4" - 2" N Scale: 10' - 27' HO Scale 5' - 15' O Scale: 3' - 8'	38/pkg	TR1570
2" - 3" N Scale: 27' - 40' HO Scale 15' - 22' O Scale: 8' - 12'	23/pkg	TR1571
3" - 5" N Scale: 40' - 67' HO Scale 22' - 36' O Scale: 12' - 20'	14/pkg	TR1572
<b>Fall Colors Deciduous</b>	<b>QTY.</b>	<b>ITEM #</b>
3/4" - 2" N Scale: 10' - 27' HO Scale 5' - 15' O Scale: 3' - 8'	38/pkg	TR1575
2" - 3" N Scale: 27' - 40' HO Scale 15' - 22' O Scale: 8' - 12'	23/pkg	TR1576
3" - 5" N Scale: 40' - 67' HO Scale 22' - 36' O Scale: 12' - 20'	14/pkg	TR1577
<b>Conifer Colors Pine</b>	<b>QTY.</b>	<b>ITEM #</b>
2 1/2" - 4" N Scale: 33' - 53' HO Scale 18' - 29' O Scale: 10' - 16'	33/pkg	TR1580
4" - 6" HO Scale 29' - 44' O Scale: 16' - 24'	24/pkg	TR1581
6" - 8" HO Scale 44' - 58' O Scale: 24' - 32'	12/pkg	TR1582
<b>Evergreen Blend Fir</b>	<b>QTY.</b>	<b>ITEM #</b>
2" - 4" N Scale: 27' - 35' HO Scale 15' - 29' O Scale: 8' - 16'	18/pkg	TR1585
4" - 6" HO Scale 29' - 44' O Scale: 16' - 24'	13/pkg	TR1586
<b>Blue Spruce</b>	<b>QTY.</b>	<b>ITEM #</b>
2" - 4" N Scale: 27' - 35' HO Scale 15' - 29' O Scale: 8' - 16'	18/pkg	TR1587
4" - 6" HO Scale 29' - 44' O Scale: 16' - 24'	13/pkg	TR1588

See page 138 for merchandiser. Color swatches may vary from actual product.

Trees

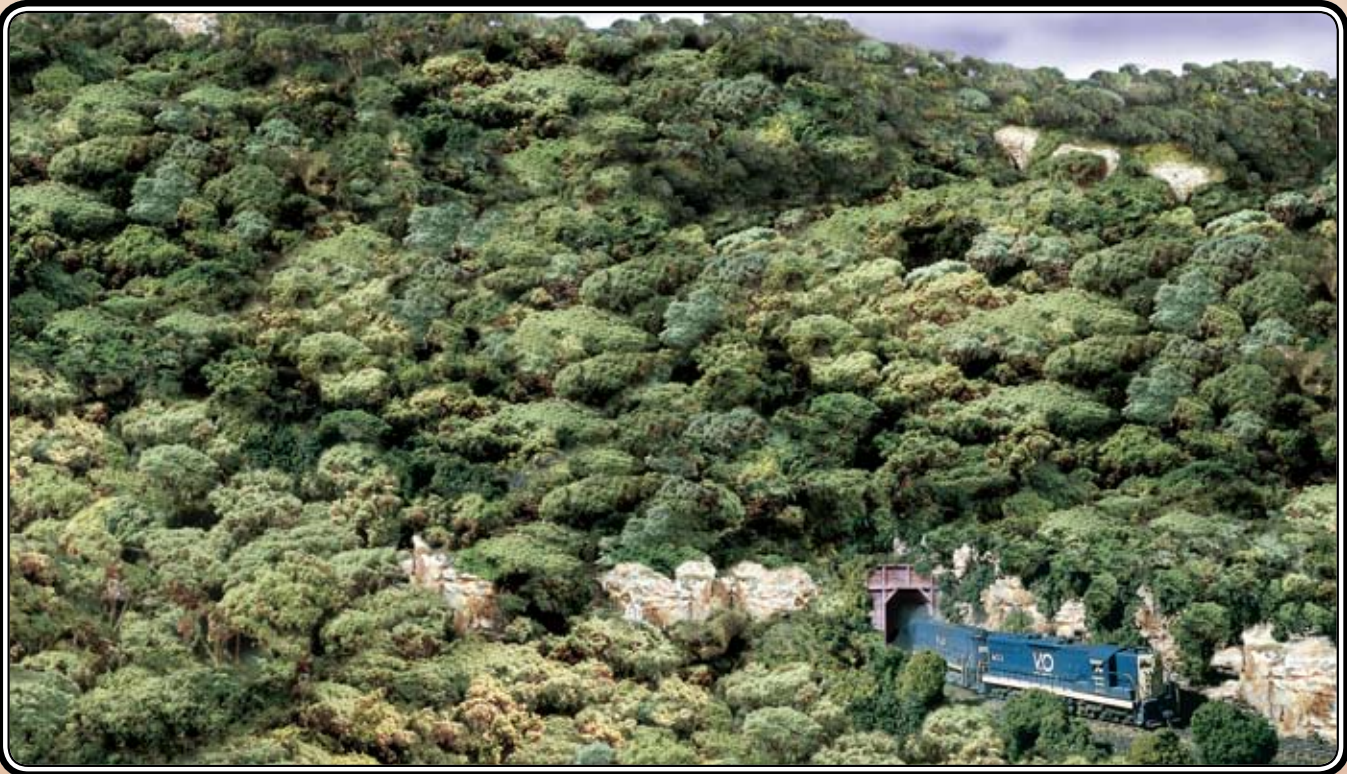

**Forest Canopy™**

**\$21.99**

This natural plant product is great for making dense forest canopies, individual trees, shrubs, bushes, dead trees and hedges. It is perfect for winter scenes, or for adding individual dead trees to your forest. Every piece of the product is useable and adds another dimension and texture to your layout or diorama. Customize pieces by breaking them into any size to fit your needs!

151 cu. in./2474 cu. cm.

- Economical forest coverage
- Great for multiple scales
- Natural plant material
- Varies in height up to six inches



**Available in Four Colors**



**Light Green** F1660



**Medium Green** F1661



**Dark Green** F1662



**Autumn Mix** F1663



Create dense forests.



Strip foliage for dead trees.



Model shrubbery.



Strip foliage to create winter scenes.

This warning applies to all products on this page.



**WARNING:** Choking Hazard! Small parts. Not intended for children under 3 yrs.

## Tree Armatures

\$12.99

Tree Armatures are bendable plastic and retain their shape once twisted. They have the texture and color of real trunks, a base pin for planting and an optional base for temporary placement. Sizes vary from 3/4" to 7". Use Hob-e-Tac Adhesive to attach foliage.



**HOW-TO VIDEOS**  
woodlandscenics.com

### TREE ARMATURES

Deciduous	QTY.	N SCALE	HO SCALE	O SCALE	ITEM #
3/4" - 2" Armatures	114/pkg	10'-27'	5'-15'	3'-8'	TR1120
2" - 3" Armatures	57/pkg	27'-40'	15'-22'	8'-12'	TR1121
3" - 5" Armatures	28/pkg	40'-67'	22'-36'	12'-20'	TR1122
5" - 7" Armatures	12/pkg	67'-94'	36'-51'	20'-28'	TR1123
Pine					
2 1/2" - 4" Armatures	70/pkg	33'-53'	18'-29'	10'-16'	TR1124
4" - 6" Armatures	44/pkg	53'-80'	29'-44'	16'-24'	TR1125

## Fine-Leaf Foliage™

\$13.99

Fine-Leaf Foliage is great for modeling bushes, saplings, shrubs, hedges and makes exquisite trees. Every piece of the product can be used. The fine-leaf detail is superb and adds a new dimension to any layout. A Tree Armature is included in each package. Attach to Tree Armatures with Hob-e-Tac Adhesive. Use Scenic Glue to attach to layout. Sizes vary from 1/2" to 8". 75 cu. in.



**Dark Green** F1130



**Medium Green** F1131



**Light Green** F1132



**Olive Green** F1133



**Dead Foliage** F1134



**Fall Mix** F1135



Color swatches may vary from actual product.

This warning applies to all products on this page.



**WARNING: Choking Hazard! Small parts. Not intended for children under 3 yrs.**

## Realistic Tree Kits™

Choose from several different sizes, shapes, textures and colors. Deciduous and pine Realistic Tree Kits include Tree Armatures with bases and foliage materials. Packages TR1101-TR1103 include a mix of three different colors. They offer tremendous variation and are economically priced. A bonus Fine-Leaf Foliage sample is included in TR1111 and TR1112. Use Hob-e-Tac Adhesive to attach foliage to Tree Armatures. Detachable bases included.



Made with Patented Products.

### DECIDUOUS COLOR



Light, Medium and Dark Green



Medium Green

### PINE COLOR



Conifer Green



Forest Green

### REALISTIC TREE KITS

Deciduous COLOR	QTY.	N SCALE	HO SCALE	O SCALE	ITEM #	
¾"-3" Light, Medium, Dark Green	36/pkg	10'-40'	5'-22'	3'-12'	TR1101	\$16.99
3"-5" Light, Medium, Dark Green	14/pkg	40'-67'	22'-36'	12'-20'	TR1102	\$16.99
5"-7" Light, Medium, Dark Green	7/pkg	67'-94'	36'-51'	20'-28'	TR1103	\$16.99
¾"-3" Medium Green	21/pkg	10'-40'	5'-22'	3'-12'	TR1111	\$13.99
3"-7" Medium Green	6/pkg	40'-94'	22'-51'	12'-28'	TR1112	\$13.99
Pines COLOR	QTY.	N SCALE	HO SCALE	O SCALE	ITEM #	
2 ½"-4" Conifer Green	42/pkg	33'-53'	18'-29'	10'-16'	TR1104	\$16.99
4"-6" Conifer Green	24/pkg	53'-80'	29'-44'	16'-24'	TR1105	\$16.99
6"-8" Conifer Green	16/pkg		44'-58'	24'-32'	TR1106	\$16.99
2 ½"-6" Forest Green	24/pkg	33'-80'	18'-44'	10'-24'	TR1113	\$13.99

## Lead-Free Metal Tree Kits

These are highly-detailed, extremely versatile trees, designed to lend realism and variety to any layout. Use Hob-e-Tac Adhesive or Scenic Glue to attach the pre-colored, non-metallic foliage to the bendable lead-free metal armatures. Lightly spray with Scenic Cement to add Fine or Coarse Turf accent colors, Fruit or Flowers.



## Small Tree Kits

\$9.99

Each tree kit contains two to five bendable lead-free metal armatures. There are ten different kits available including deciduous, pine and dead trees.



**Forked Tree TK11**  
2 1/4" (4/kit)



**Ornamental TK12**  
2 1/2" (5/kit)



**Straight Trunk TK13**  
2 1/2" (5/kit)



**Softwood Pine TK14**  
3 1/4" (5/kit)



**Shag Bark TK17**  
3 1/2" (3/kit)



**Double Forked TK18**  
3 1/2" (2/kit)



**Shade Tree TK19**  
4" (2/kit)



**Columnar Pine TK20**  
4 1/2" (4/kit)



**Gnarled TK21**  
4 1/2" (2/kit)



**Dead Trees TK22**  
(5/kit)

Color swatches may vary from actual product.

Trees

This warning applies to all products on this page.



**WARNING:** Choking Hazard! Small parts. Not intended for children under 3 yrs.

### Large Tree Kits

**\$19.99**

These bendable lead-free metal tree kits take tree making to new heights! Use large kits to set striking tree scenes.



**Pine Tree** TK23  
6" - 9" (5/kit)



**Hedge Row Scene** TK24  
24" - 30" (18 trees & 6 bushes/kit)



**Hardwood Trees** TK25  
5 1/2" - 6 1/2" (3/kit)



**Big Old Trees** TK26  
7" - 7 1/2" (2/kit)

### Forest Kits

**\$19.99**

Create a forest of trees with bendable, lead-free metal armatures and foliage. The Pine and Hardwood Forest tree kits offer the most economical option for adding trees to layouts.



**Pine Forest** TK27  
2" - 4" (24/kit)



**Hardwood Forest** TK28  
2" - 4" (24/kit)

Trees



## Ready-To-Go Products

Great layouts don't have to take all of your free time. These products are ready to set right on your layout. They're great for kids, and perfect for adults with busy lives. Best of all, your layout will look like you spent hours...only you will know how easy it was!

### Built-&-Ready Landmark Structures

These preassembled, hand-painted and fully detailed N and HO scale structures are great for building cities, towns and villages. Each is individually molded with intricate architectural and scene-setting details.



### Scenic Accents

This economically priced collection of N, HO, O and G scale figures, animals and accessories are sculpted and hand-painted in fine detail, and add color, interest and life to any layout. These works of art exude personality, their natural charm and realistic appearance steal the show!



### Ready Landforms

Pre-formed, durable and fully landscaped, Ready Landforms easily blend with any layout. Tunnels and Rocky Ridges are the perfect complements to ReadyGrass Vinyl Mats.



### Ready Made Realistic Trees, Premium Trees, Ready Made Trees Value Pack and Woodland Classics

No assembly required! These trees lend authenticity to any layout or diorama. Their natural colors and realistic textures blend with other Woodland Scenics landscape products. Plant trees in clusters and intermix foliage colors.



### ReadyGrass Vinyl Mat

Its unique characteristics make this non-shedding, vinyl grass mat the best on the market...ideal for layouts, battle mats, arts and crafts and other projects. They can be formed with a heat tool, permanently mounted, or laid flat for a display, then rolled up and used again and again! Four colors available in four sizes.



### AutoScenes

AutoScenes figures capture the classic designs and simple lifestyles of the 1940's and '50s. Each finely crafted, custom painted automobile, figure and accessory adds humor, color, interest and authenticity to any layout, diorama or project. AutoScenes are true 1:16 N scale and 1:87 HO scale models.



This warning applies to all products on this page.  **WARNING:** Choking Hazard! Small parts. Not intended for children under 3 yrs.

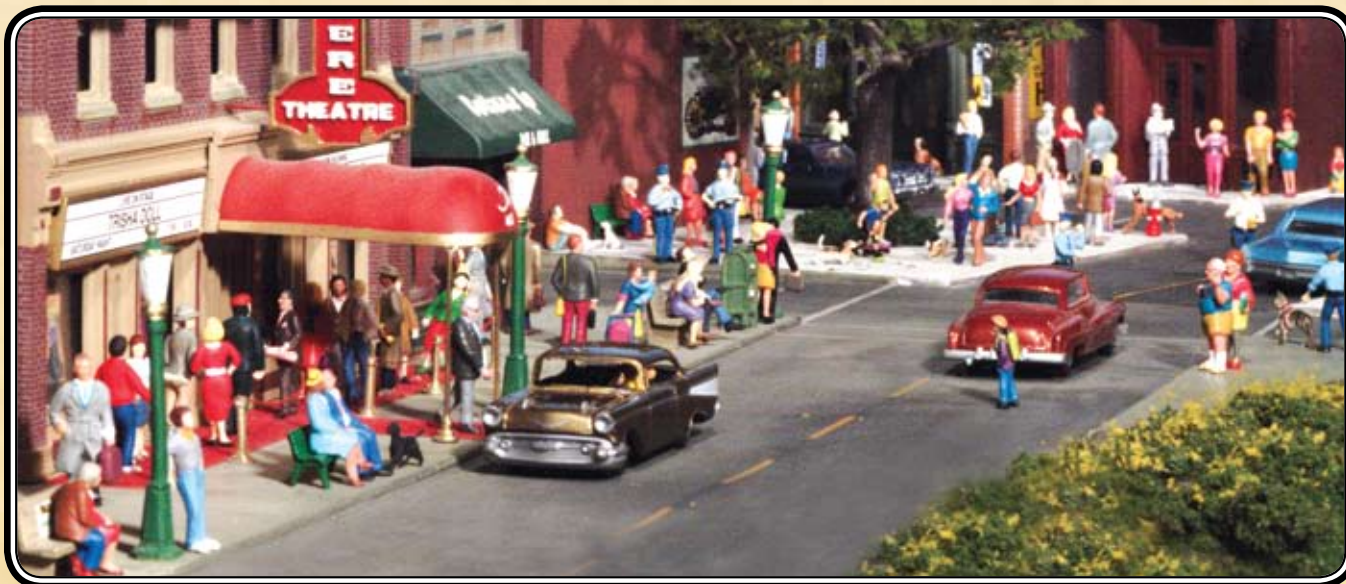

## N, HO, O and G Scale Scenic Accents

This economically priced collection of N, HO, O and G scale figures, animals and accessories are sculpted and hand-painted in fine detail, and add color, interest and life to any layout. These works of art exude personality—their natural charm and realistic appearance steal the show!

## Scenic Accents®



**Pedestrians**

HO	N
A1821	A2121
\$9.99	\$10.49

**Policemen**

HO	N	O
A1822	A2122	A2736
\$9.99	\$10.49	\$19.99

**Dock Workers**

HO	N	O
A1823	A2123	A2729
\$11.49	\$11.49	\$19.99

**Ordinary People\***

HO	N
A1824	RETIRED
\$9.99	

**Window Shoppers**

HO	N
A1825	A2125
\$8.99	\$10.49

**City Workers**

HO	N	O
A1826	A2126	A2742
\$11.49	\$11.49	\$21.99

**People & Pets**

HO	N
A1827	A2143
\$9.99	\$10.49

**Roofers**

HO	N
A1828	A2128
\$11.49	\$11.49

See pages 139 and 140 for merchandisers. Availability subject to change. Colors may vary from actual product. \*Benches and/or walls not included.

This warning applies to all products on this page.



**WARNING:** Choking Hazard! Small parts. Not intended for children under 3 yrs.



**People Sitting\***

HO N  
A1829 A2129  
\$9.99 \$10.49



**Kids at Play**

HO  
RETIRED



**Active People**

HO  
RETIRED



**Mom & Kids\***

HO  
A1832  
\$9.99



**Lovers**

HO N  
A1833 A2133  
\$8.99 \$10.49



**Sitting & Waiting\***

HO  
A1834  
\$8.99



**Professionals**

HO N  
A1835 A2135  
\$9.99 \$10.49



**Tourists**

HO  
RETIRED



**General Public**

HO N O  
A1837 A2149 A2730  
\$9.49 \$10.49 \$18.99



**People Talking**

HO  
RETIRED



**Commuters\***

HO N  
A1839  
RETIRED  
\$8.99



**Travelers\***

HO N  
A1840 A2155  
\$9.99 \$11.49



**Dogs & Cats**

HO N O  
A1841 A2140 A2725  
\$11.49 \$11.49 \$19.99



**Chestnut Horses**

HO  
A1842  
\$10.49

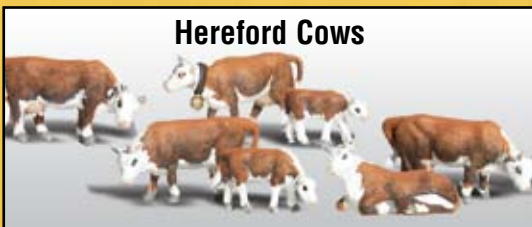

**Hereford Cows**

HO N  
A1843 A2144  
\$10.49 \$10.49



**Livestock**

HO  
A1844  
\$10.49

Availability subject to change. Colors may vary from actual product. \*Benches and/or walls not included.

This warning applies to all products on this page. **WARNING: Choking Hazard! Small parts. Not intended for children under 3 yrs.**



**Full Figured Folks**

HO	N	O
A1845	A2130	A2728
\$11.49	\$11.49	\$19.99



**Recreational People**

HO
A1846
\$9.99



**Train Personnel**

HO	N	O
A1847	A2131	A2722
\$11.49	\$11.49	\$18.99



**Checker Players**

HO	N	O
A1848	A2132	A2727
\$11.49	\$11.49	\$19.99



**Rebels\***

HO	N
A1849	A2136
\$10.49	\$10.49



**Road Crew**

HO	N
A1850	A2137
\$10.49	\$10.49



**Road Crew Details**

HO
A1851
\$11.49



**Assorted Junk**

HO	N
A1852	A2163
\$14.99	\$13.99



**Sun Bathers**

HO
A1853
\$10.49



**Assorted Skids**

HO	N
<del>RETIRED</del>	<del>RETIRED</del>



**Assorted Crates**

HO	N	O
A1855	A2162	A2739
\$15.99	\$12.49	\$21.99

Quantities vary per scale.



**Tombstones**

HO	N	O
A1856	A2164	A2726
\$15.99	\$12.49	\$18.99

HO scale set contains 20 tombstones.



**Farm People**

HO	N
A1857	A2152
\$11.49	\$12.49



**Chain Gang**

HO	N	O
A1858	A2167	A2745
\$11.49	\$12.99	\$21.99



**Train Mechanics**

HO	N	O
A1859	A2147	A2721
\$11.49	\$11.49	\$18.99



**Hobos\***

HO	N	O
A1860	A2188	A2734
\$11.49	\$11.49	\$19.99

Availability subject to change. Colors may vary from actual product. \*Benches and/or walls not included.

This warning applies to all products on this page.



**WARNING:** Choking Hazard! Small parts. Not intended for children under 3 yrs.



**Bus Stop People\***

HO	N
A1861	A2134
\$10.49	\$10.49



**Farm Horses**

HO	N
A1862	A2141
\$10.49	\$10.49



**Holstein Cows**

HO	N	O
A1863	A2187	A2724
\$10.49	\$11.49	\$18.99



**Hampshire Pigs**

HO	N
A1864	A2139
\$11.49	\$11.49



**Track Workers**

HO	N	O
A1865	A2148	A2723
\$11.49	\$12.49	\$19.99



**Engineers\***

HO	N	O
A1866	A2153	A2733
\$11.49	\$11.49	\$19.99



**Factory Workers\***

HO	N	O
A1867	A2154	A2746
\$11.49	\$11.49	\$21.99



**Graveside Service**

HO	N
A1868	A2127
\$11.49	\$11.49



**Baseball Players I**

HO	N
A1869	A2145
\$11.49	\$11.49



**Baseball Players II**

HO	N
A1870	A2146
\$11.49	\$11.49



**Welders & Accessories**

HO	N	O
A1871	A2157	A2748
\$12.49	\$12.99	\$21.99



**Bystanders\***

HO	N	O
A1872	A2156	A2732
\$10.49	\$10.49	\$18.99



**Passengers\***

HO	N	O
A1873	A2190	A2731
\$10.49	\$11.49	\$18.99



**Casual People\***

HO	N
A1874	A2168
\$10.49	\$11.49



**People & Pesky Raccoons**

HO	N
RETIRED/ A2158	
\$12.49	

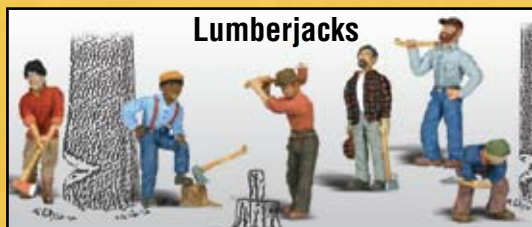

**Lumberjacks**

HO	N	O
A1876	A2160	A2735
\$11.49	\$12.99	\$19.99

Availability subject to change. Colors may vary from actual product. \*Benches and/or walls not included.

This warning applies to all products on this page. **WARNING: Choking Hazard! Small parts. Not intended for children under 3 yrs.**



**Shoe Shiners**

HO	N
RETIRED	
\$12.49	A2176



**Gone Fishing**

HO	N	O
RETIRED		
\$12.49	A1878	
\$12.99	A2179	
\$22.99	A2751	



**Park Benches**

HO	N	O
		NEW
\$10.49	A1879	
\$9.99	A2181	
\$14.99	A2758	



**Game of Horseshoes**

HO	N
RETIRED	
RETIRED	



**Spectators**

HO	N
RETIRED	
\$12.49	A1881
\$13.49	A2172

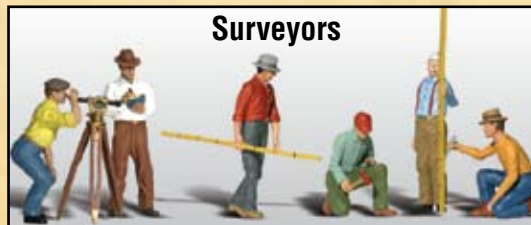

**Surveyors**

HO	N	O
RETIRED		
\$12.99	A2175	
\$19.99	A2741	



**Deer**

HO	N	O
\$11.49	A1884	
\$11.99	A2185	
\$19.99	A2738	



**Black Bears**

HO	N	O
\$10.49	A1885	
\$11.49	A2186	
\$19.99	A2737	



**2nd Shift Workers**

HO	N
RETIRED	
\$11.99	A2188



**Dairy Farmers**

HO	N
\$12.49	A1887
\$12.49	A2166



**Farm Animals**

HO	N
\$10.49	A1888
\$10.49	A2142

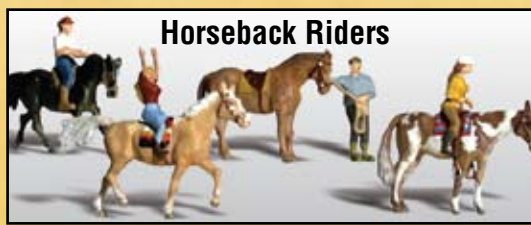

**Horseback Riders**

HO	N
\$11.49	A1889
\$12.99	A2159



**Firemen to the Rescue**

HO	N
RETIRED	
\$12.49	A2151



**Painters**

HO	N
\$12.49	A1890
\$12.99	A2174



**Children**

HO	N
\$10.49	A1891
\$11.49	A2182



**Uniformed Travelers**

HO
\$11.49
A1892

Availability subject to change. Colors may vary from actual product.

This warning applies to all products on this page.



**WARNING:** Choking Hazard! Small parts. Not intended for children under 3 yrs.



**Accident Waiting to Happen**

HO	N
A1893	A2171
\$12.49	\$13.49



**Snowball Fight**

HO	N
A1894	RETIRED
\$12.49	



**Youth Football Players**

HO	N
A1895	A2169
\$16.99	\$17.99



**Farmers Market**

HO	N	O
A1896	RETIRED	A2750
\$14.99		\$22.99



**Beekeepers**

HO	N
A1897	A2178
\$12.49	\$12.99



**Rail Workers**

HO	N	O
A1898	A2177	A2747
\$12.49	\$12.99	\$22.99



**Ice Skaters**

HO	N
A1899	A2184
\$12.49	\$12.99



**Couples in Coats**

HO	N
RETIRED	A2189
	\$11.99



**Masonry Workers**

HO	N	O
A1901	A2173	A2753
\$13.99	\$12.99	\$22.99



**Jug Band**

HO	N	O
A1902	A2180	A2743
\$12.49	\$13.99	\$21.99



**Rabbit Hunt**

HO	
A1903	
\$12.49	



**Bicycle Buddies**

HO	N	O
A1904	A2194	A2752
\$16.99	\$14.99	\$21.99



**Dog Wash**

HO	N
A1905	A2195
\$13.99	\$15.99



**Newsstand**

HO	N	O
A1906	A2191	A2740
\$12.99	\$13.99	\$20.99



**Golfers**

HO	
A1907	
\$11.99	



**Sixteen Passengers\***

HO	
A1908	
\$17.99	

*Figures & Accents*

Availability subject to change. Colors may vary from actual product. \*Benches and walls not included.

This warning applies to all products on this page. **WARNING: Choking Hazard! Small parts. Not intended for children under 3 yrs.**



**Depot Workers & Accessories**

HO	N	O
A1909	NEW	NEW
\$13.99	\$15.99	\$22.99



**Fly Fishermen**

HO
A1910
\$12.99



**Workers with Forklift**

HO	N	O
A1911	A2192	A2744
\$13.99	\$14.99	\$21.99



**Goodbye People**

HO	N
A1912	A2193
\$9.99	\$9.99



**People Walking**

HO	N
A1913	NEW
\$9.99	\$8.99



**Auto Mechanics**

HO
A1914
\$11.99

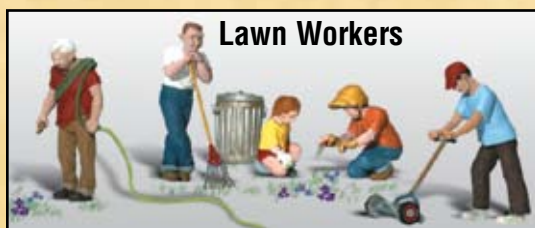

**Lawn Workers**

HO	N
A1915	A2204
\$11.99	\$13.99



**Park Bums**

HO	N	O
A1916	A2196	A2749
\$13.99	\$15.99	\$22.99



**Campers**

HO	N	O
A1917	A2199	NEW
\$13.99	\$12.99	\$22.99

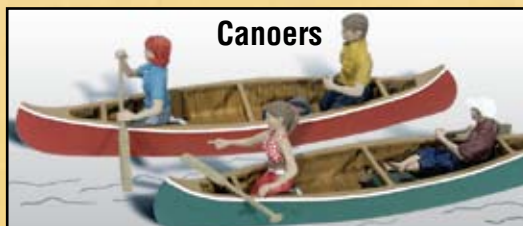

**Canoers**

HO	N	O
A1918	A2200	NEW
\$13.99	\$12.99	\$22.99



**Smoke Jumpers**

HO
A1919
\$13.99



**Picket Line**

HO	N
A1920	A2197
\$13.99	\$13.99



**Playtime**

HO	N
A1921	A2198
\$13.99	\$12.99



**Senior Citizens**

HO	N
A1922	A2201
\$10.99	\$9.99



**Family Fishing**

HO	N	O
A1923	A2203	NEW
\$16.99	\$15.99	\$22.99



**People on Benches**

HO	N
A1924	A2206
\$11.99	\$12.99



This warning applies to all products on this page.



**WARNING:** Choking Hazard! Small parts. Not intended for children under 3 yrs.



**Sermon on the Crate**

HO  
A1925  
\$12.99



**Shootin' Hoops**

HO N  
A1926  
\$15.99 \$15.99  
A2207



**One Man Crew**

HO N  
A1927  
\$13.99 \$13.99  
A2205



**Garage Treasures**

HO N  
A1928  
\$13.99 \$14.99  
A2212 NEW



**Backyard Barbeque**

HO N  
A1929  
\$15.99 \$14.99  
A2209 NEW



**The Founders**

HO  
A1930  
\$14.99



**Backyard Basics**

HO  
A1931  
\$15.99



**Barnyard Animals**

N  
A2202  
\$9.99



**Miners**

HO  
A1933  
\$15.99



**Loading Dock Details**

HO N  
A1934  
\$15.99 \$14.99  
A2208 NEW



**Backyard Birthday**

HO  
A1935  
\$18.99



**Summertime Jobs**

HO  
A1938  
\$18.99



**Outdoor Dining**

HO  
A1939  
\$16.99



**Ridin' & Ropin'**

HO  
A1940  
\$17.99



**Wedding Bouquet Toss**

HO  
A1932  
\$15.99



**Wildlife Standoff**

HO NEW  
A1942  
\$18.99

*Figures & Accents*

This warning applies to all products on this page. **WARNING:** Choking Hazard! Small parts. Not intended for children under 3 yrs.



**Wash Day Getaway**

HO  
A1936  
\$17.99



**Windy Day Play**

HO  
A1937  
\$18.99



**Street Accessories**

HO  
NEW  
A1941  
\$18.99



**Playground Fun**

HO  
NEW  
A1943  
\$18.99



**Take a Hike**

HO  
NEW  
A1944  
\$18.99



**Wally's Wiener Wagon**

HO  
NEW  
A1945  
\$18.99



**Physically Challenged**

HO  
NEW  
A1946  
\$18.99



**Carpenter Crew**

HO  
NEW  
A1947  
\$17.99



**Service Station Attendants**

HO  
NEW  
A1948  
\$18.99



**Cougars and Cubs**

HO  
NEW  
A1949  
\$18.99

**WATCH FOR FUTURE RELEASES!**

**Scenic Accents Economy Packs** 

**\$109.99**

Save more than 30% over items purchased separately when adding people, animals and accessories to your layout. Three different packages are available in either N or HO scale. Each package contains over 100 themed pieces and may vary in contents. Limited supply available.



**Assorted Farm Set**  
HO - A2051 N - A2061



**Assorted Worker Set**  
HO - A2052 N - A2062



**Assorted Figure Set**  
HO - A2053 N - A2063



**Scenic Accents Glue** A198

**\$4.49**

This adhesive is specially formulated for attaching Scenic Accents or other types of figures to a layout. Scenic Accents Glue stays tacky and allows for repositioning, without having to reapply glue. Sand glue points and apply glue. Let dry until clear and tacky, then place on layout. A brush applicator is included.

1.25 fl. oz.



**Gentle Grips®** A200

**\$6.99**

This unique tweezer is used for positioning Scenic Accents or other scale figures. The protective tips will not damage figures. Gentle Grips come in a handy storage tube and feature non-slip grips.

6 inch tines



**SCALE CHART**

"In Scale" is the relationship between the size of two items. In model railroading, it is generally expressed as a ratio. For example, HO scale is 1:87, that is one inch on the model to 87 inches in the real world. This chart shows the average man in common scale in model railroading.

Figures shown actual size.

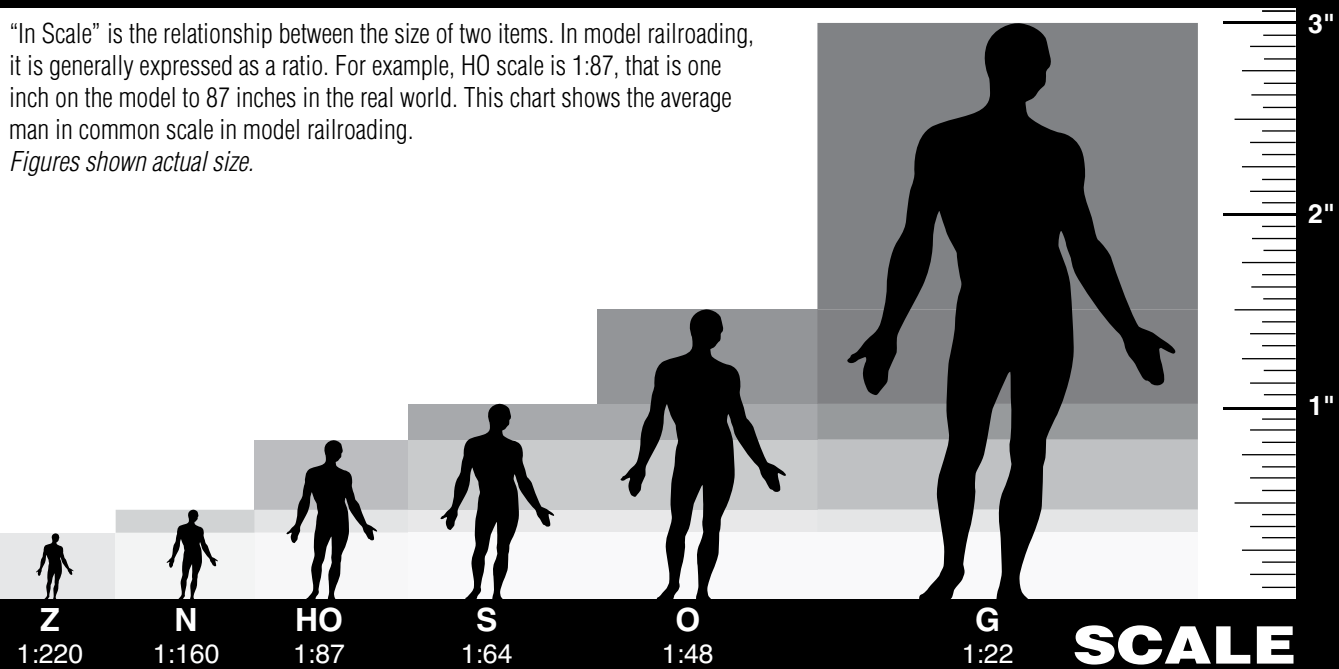

 **CHOKING HAZARD** (see page 2) Not intended for children under 3 yrs.

This warning applies to all products on this page.  **WARNING: Choking Hazard! Small parts. Not intended for children under 3 yrs.**

# Figures & Accents

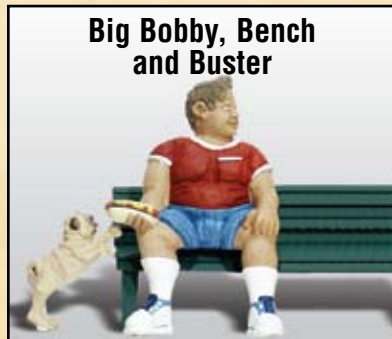

**Big Bobby, Bench and Buster**

G

\$18.49 A2521



**The Checker Brothers and Hound**

G

\$29.99 A2522

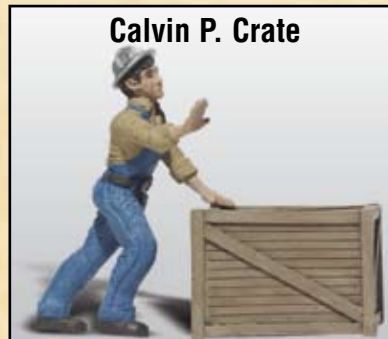

**Calvin P. Crate**

G

RETIRED

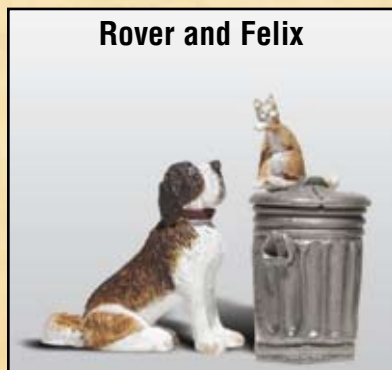

**Rover and Felix**

G

\$14.49 A2524

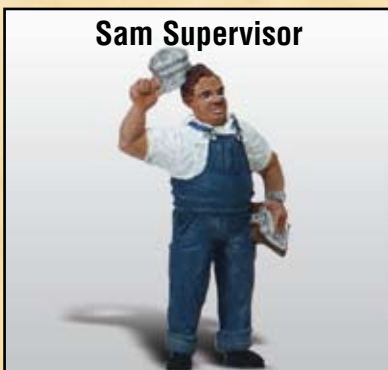

**Sam Supervisor**

G

\$13.49 A2525

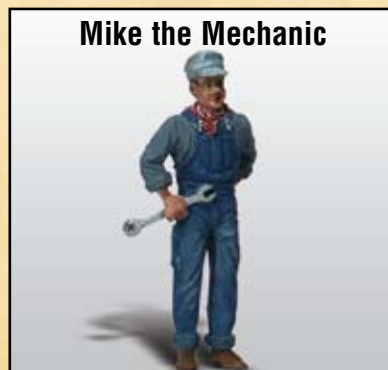

**Mike the Mechanic**

G

\$13.49 A2526

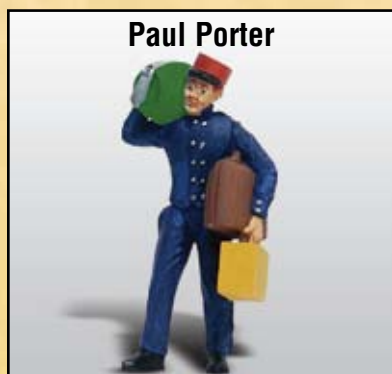

**Paul Porter**

G

\$13.49 A2527

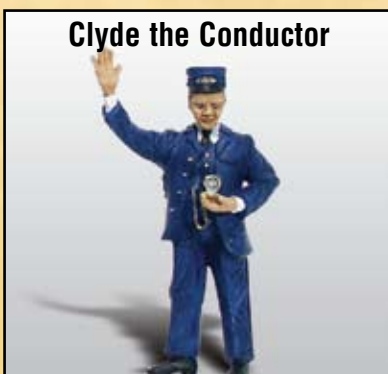

**Clyde the Conductor**

G

\$13.49 A2528

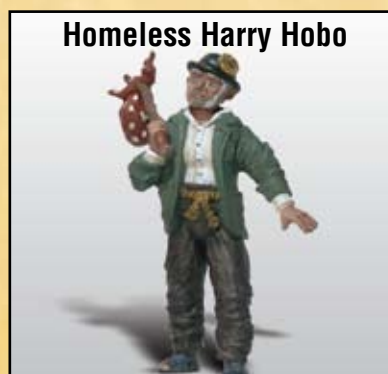

**Homeless Harry Hobo**

G

\$14.49 A2529

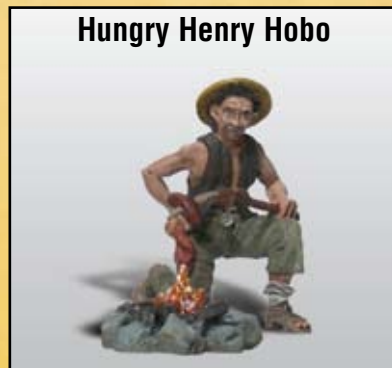

**Hungry Henry Hobo**

G

\$14.49 A2530

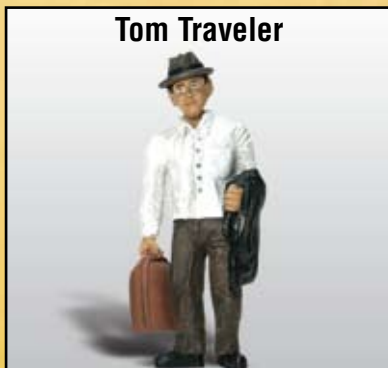

**Tom Traveler**

G

\$13.49 A2531



**Officer Dunkin**

G

\$13.49 A2532



**Doug and Phil Shoveler**

G

\$18.99 A2533

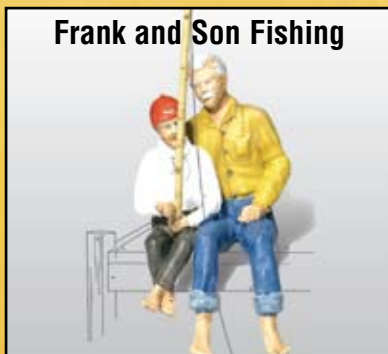

**Frank and Son Fishing**

G

RETIRED

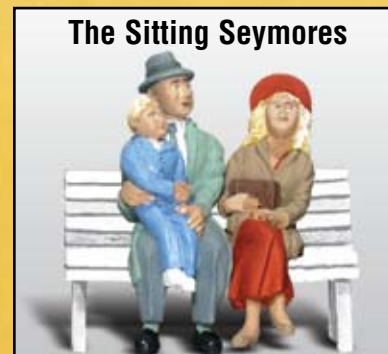

**The Sitting Seymores**

G

RETIRED

Availability subject to change. Colors may vary from actual product.

This warning applies to all products on this page.



**WARNING:** Choking Hazard! Small parts. Not intended for children under 3 yrs.

*Figures & Accents*



G  
\$12.49 A2536

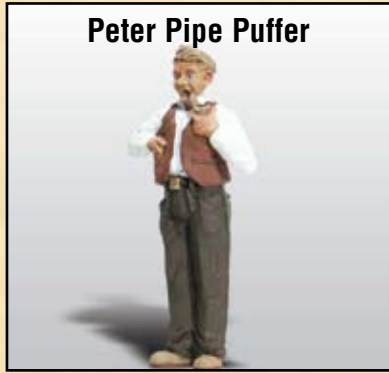

G  
\$12.49 A2537



G  
\$12.49 A2538



G  
\$18.99 A2539



G  
\$18.99 A2540



G  
\$18.99 A2541

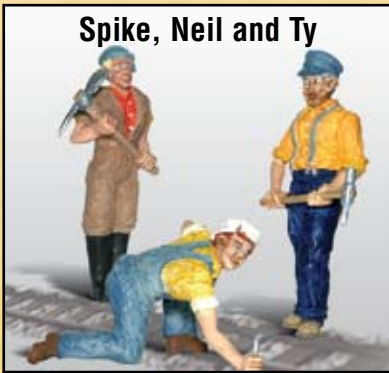

G  
\$29.99 A2542



G  
\$29.99 A2543



G  
\$29.99 A2544



G  
\$29.99 A2545



G  
\$29.99 A2546



G  
\$29.99 A2547



G  
\$29.99 A2548

This warning applies to all products on this page.  **WARNING:** Choking Hazard! Small parts. Not intended for children under 3 yrs.



Three Train Mechanics

G

A2549  
\$29.99



Horse Shoein' Around

G

RETIRED



Harry Bear and Family

G

A2551  
\$29.99



Chip, Woody and Chopper

G

A2552  
\$29.99



Milkin' Ol' Bessie

G

A2553  
\$29.99



Tombstones

G

A2554  
\$28.99



Dedicated Depot Workers

G

A2555  
\$29.99

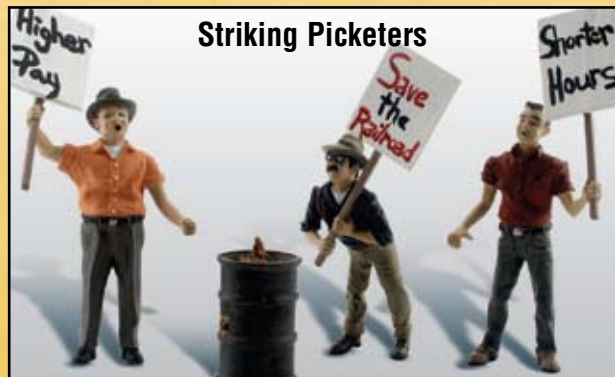

Striking Picketers

G

A2557  
\$29.99



All Aboard

G

A2558  
\$25.99



Ned's Newsstand

G

A2559  
\$27.99

This warning applies to all products on this page.



**WARNING:** Choking Hazard! Small parts. Not intended for children under 3 yrs.

*Figures & Accents*



**Hilow Bros. Surveying Co.**

G

\$29.99 A2556



**Polly's Postal Pursuit**

G

\$24.99 A2560

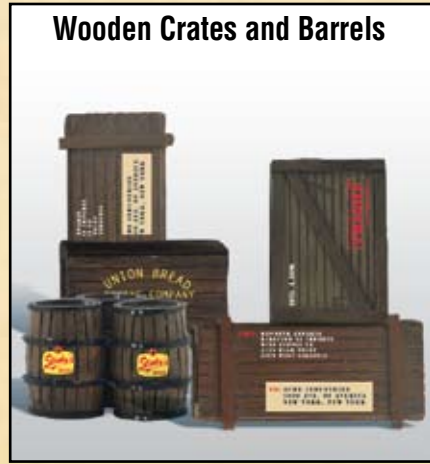

**Wooden Crates and Barrels**

G

\$28.99 A2564

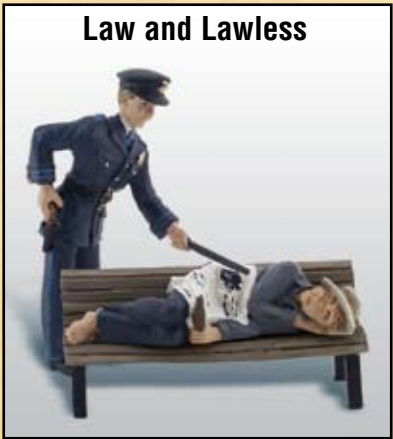

**Law and Lawless**

G

\$25.99 A2561

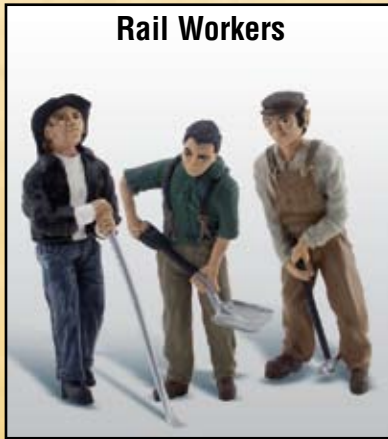

**Rail Workers**

G

\$25.99 A2562



**You Dirty Dog**

G

NEW

\$23.99 A2566

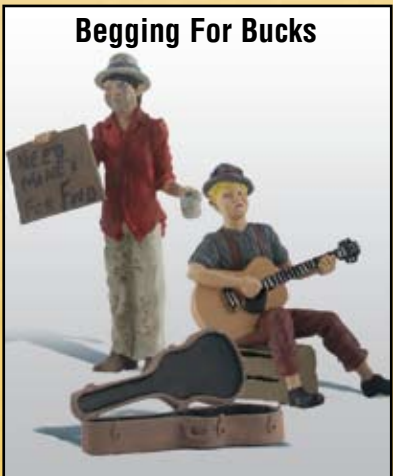

**Begging For Bucks**

G

\$23.99 A2563



**Dock Crew**

G

\$21.99 A2565

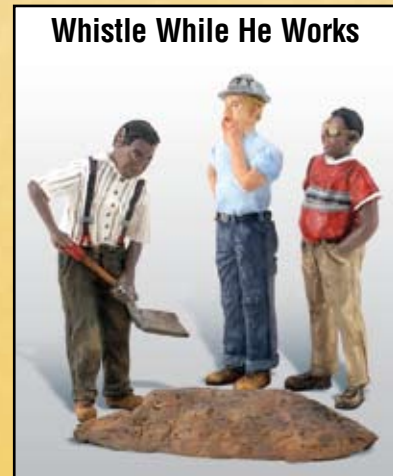

**Whistle While He Works**

G

NEW

\$22.99 A2568



**Camp Couple**

G

NEW

\$21.99 A2567



**Fishing Buddies**

G

NEW

\$21.99 A2569

Availability subject to change.

Decals and colors may vary from photo.

This warning applies to all products on this page.



**WARNING:** Choking Hazard! Small parts. Not intended for children under 3 yrs.

## Scenic Details®

Scenic Details kits are finely crafted HO scale reproductions. They are economical, easy to assemble and fun to paint! The highly detailed, lead-free metal castings like junk, crates, skids, street lights, mailboxes and farm implements can be used everywhere on your layout. When layout landscape is complete, add color and interest to tracks and rail yards, along city streets and rural lanes, beside warehouse docks and farm buildings. Attach to layout with Scenic Accents Glue, Hob-e-Tac Adhesive or Scenic Glue. Some kits include Dry Transfer Decals. We recommend using super glue or a two-part epoxy to assemble Scenic Details. Scene measurements are approximate. Painting with Mini-Scene Paint Set (page 91) is recommended.



**\$8.99**

### 20 Tombstones

D201 (3 3/4" diameter x 1 1/4" tall)



**\$6.99**

### Trackside Junk

D202 (4" diameter x 1 1/4" tall)



**\$7.99**

### Crates-Barrels-Sacks

D203 (4" diameter x 1" tall)



**\$6.99**

### 15 Assorted Skids

D204 (4" diameter x 3/8" tall)



**\$7.99**

### Assorted Junk Piles

D205 (4" diameter x 1/2" tall)



**\$6.99**

### Assorted Mailboxes

D206 (4" diameter x 5/8" tall)



**\$8.99**

### "Aermotor" Windmill

D209 (1 1/2" diameter x 4 1/2" tall)



**\$8.99**

### Plow, Disc, Horse and Man

D210 (3 1/8" diameter x 3/4" tall)



**\$8.99**

### 3 Fuel Stands

D212 (3 1/4" long x 1 3/4" tall)



**\$6.99**

### Industrial Junk

D225 (3 1/2" diameter x 1/2" tall)



**\$7.99**

### Cats and Dogs

D226 (3 3/4" diameter x 1" tall)



**\$6.99**

### Bare Hunter

D227 (1 3/4" diameter x 5/8" tall)

See page 143 for merchandiser.



This warning applies to all products on this page.  **WARNING: Choking Hazard!** Small parts. Not intended for children under 3 yrs.

\$8.99



**Steam Engine and Hammer Mill**  
D229 (2 1/4" long x 1 5/8" tall)

\$8.99



**8 Vending Machines**  
D230 (3 1/4" diameter x 1 1/8" tall)

\$8.99



**Trackside Scale**  
D231 (2" diameter x 2 1/4" tall)

\$8.99



**Diesel Fuel Facility**  
D232 (4 1/4" long x 1 5/8" tall)

\$10.99



**Gazebo**  
D236 (1 1/2" diameter x 2 1/4" tall)

\$16.99



**Branch Line Water Tower**  
D241 (3 3/8" long x 3 3/4" tall)

\$10.99



**Rural Sawmill**  
D243 (3 1/4" long x 2" tall)

\$8.99



**Street and Traffic Lights**  
D248 (3" diameter x 2 5/8" tall)



Scenic Details, Mini Scene, Complete Scenes and Trackside Scenes all contain lead-free, metal castings that are highly detailed, easy to assemble and fun to paint! Clean castings and assemble pieces according to included easy-to-follow diagrams and instructions. We recommend using super glue or two-part epoxy. Let dry and paint.

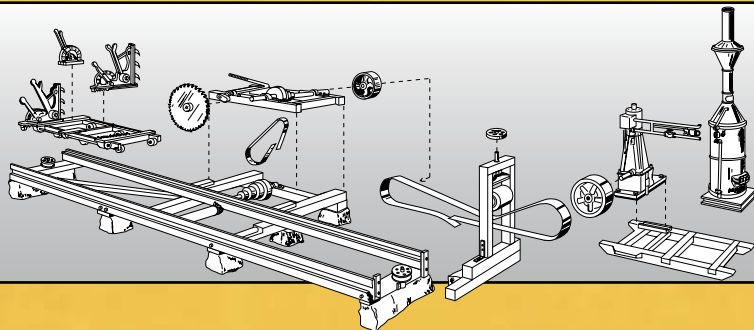

This warning applies to all products on this page.



**WARNING:** Choking Hazard! Small parts. Not intended for children under 3 yrs.

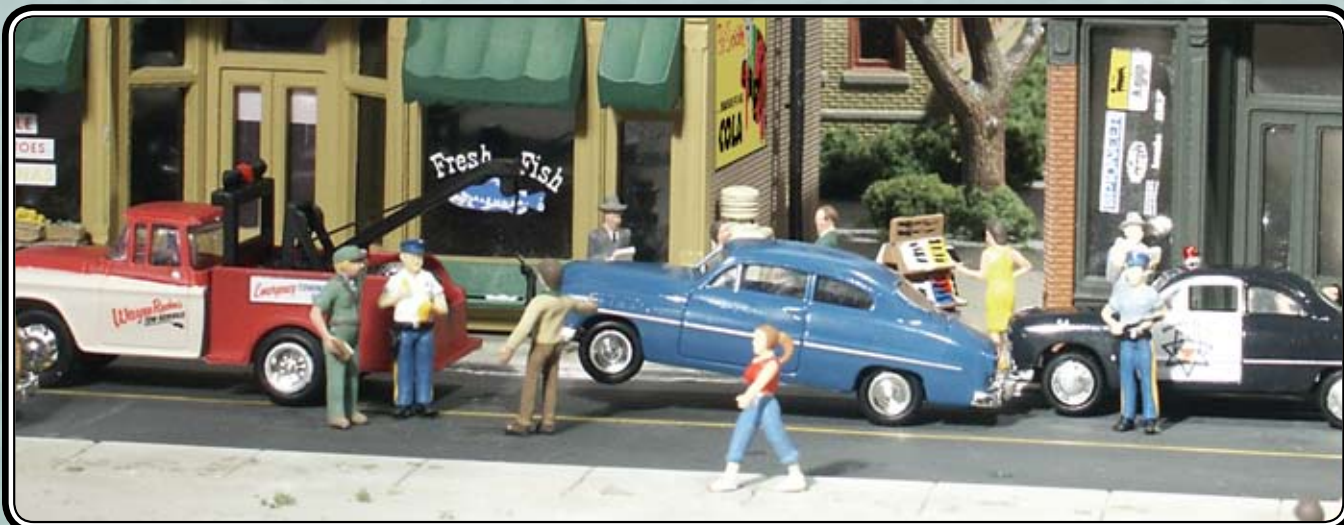

## N and HO Scale AutoScenes

AutoScenes capture the classic designs and simple lifestyles of the 1940's and '50s. Each finely crafted, custom painted automobile, figure and accessory adds humor, color, interest and authenticity to any layout, diorama or project. AutoScenes are true 1:16 N scale and 1:87 HO scale models.



**Hall & Duke**



HO	N
AS5521	AS5321
\$15.29	\$12.99

**Billy Brown's Coupe**



HO	N
AS5522	AS5322
\$13.99	\$11.99

**Felix Fix-a-Flat**



HO	N
AS5523	AS5323
\$16.29	\$12.99

**Family Vacation**



HO	N
AS5525	AS5325
\$17.29	\$13.99

**Wayne Recker's Tow Service**



HO	N
AS5524	AS5324
\$28.49	\$24.99
	<b>NEW</b>

**Lubeners Loading**



HO	N
<b>RETIRED</b>	AS5326
	\$12.99

**Roger's Rag Top**



HO	N
AS5527	AS5327
\$13.99	\$10.99
	<b>NEW</b>

See page 140 for merchandisers. Availability subject to change. Colors may vary from actual product.

This warning applies to all products on this page.  **WARNING:** Choking Hazard! Small parts. Not intended for children under 3 yrs.

### Willie's Warning



HO	N
AS5528	AS5333
\$26.49	\$21.99

### Mickey's Milk Delivery



HO	N
AS5529	NEW AS5329
\$17.29	\$12.99

### Spoonin'-N-Croonin'



HO	N
AS5530	NEW AS5330
\$15.29	\$11.99

### Rusty's Regret



HO	N
RETIRED AS5331	
	\$11.99

### Suds & Shine



HO	N
AS5533	NEW AS5339
\$16.29	\$15.99

### Thompson's Travelin' Trailer



HO	N
AS5532	AS5328
\$26.49	\$18.99

### Pick'em Up Truck



HO	N
AS5534	AS5332
\$13.99	\$12.99

### Sunday Drive



HO	N
AS5535	AS5334
\$16.29	\$12.99

### Cruisin' Coupes



HO	
AS5536	
\$24.49	

### Cop'n a Kiss



HO	N
AS5537	NEW AS5337
\$16.99	\$13.99

### Henry's Haulin'



HO	N
AS5538	AS5335
\$22.99	\$15.99

Vehicles

This warning applies to all products on this page.



**WARNING:** Choking Hazard! Small parts. Not intended for children under 3 yrs.

# Vehicles

## Peter's Painting



HO

AS5539

\$17.99

## Ike's Ice Cream Truck



HO

N

NEW

AS5541

\$24.99

AS5338

\$16.99

## Getaway Gangsters



HO

RETIRED

## Ma & Pa's Trailer Haven



HO

AS5542

\$25.99

## Shove It or Leave It



HO

N

NEW

AS5543

\$16.99

AS5336

\$12.99

## Pit Stop



HO

AS5546

\$17.99

## To The Lake



HO

AS5544

\$25.99

## Rusty Springs Furniture



HO

AS5545

\$27.99

## Carburetor Chaos



HO

N

NEW

AS5548

\$21.99

AS5340

\$15.99

Availability subject to change. Colors may vary from actual product.

This warning applies to all products on this page.



**WARNING:** Choking Hazard! Small parts. Not intended for children under 3 yrs.

# Vehicles

### Hitchin' A Ride



HO

AS5547  
\$15.99

### Born to Ride



HO

AS5549  
\$19.99

### Dog Gone Animal Control



HO

AS5551  
\$24.99

### Parked for a Picnic



HO

AS5552  
\$21.99

### Rocky's Road Repair



HO

AS5550  
\$21.99

### Tim Burr Logging



HO

AS5553  
\$27.99

### Bad Boy Bikers



HO

NEW

AS5554  
\$21.99

### Lumpy's Coal Company



HO

NEW

AS5555  
\$29.99

### Chip's Ice Truck



HO

NEW

AS5557  
\$29.99

### Fritz's Front Loader



HO

NEW

AS5558  
\$17.99

### Sign Slingers



HO

NEW

AS5556  
\$44.99

**WATCH FOR FUTURE  
RELEASES!**

Availability subject to change. Colors may vary from actual product.

This warning applies to all products on this page.  **WARNING: Choking Hazard! Small parts. Not intended for children under 3 yrs.**

## Scenic Details®

These are finely crafted HO scale reproductions—highly detailed and lead-free metal castings of junk, crates, skids, street lights, mailboxes, farm implements and more! Scenic Details are economical, easy to assemble, fun to paint and they add color, interest and authenticity to any layout. When layout is complete, add to tracks and rail yards, along city streets and rural lanes and beside warehouse docks and farm buildings. Colorful Dry Transfer Decals are included in some kits. Attach to layout with Scenic Accents Glue, Hob-e-Tac Adhesive or Scenic Glue. We recommend using super glue or a two-part epoxy to assemble Scenic Details. Painting with Mini-Scene Paint Set (page 91) is recommended.



**\$8.99**



**Disc and Tractor (1938-1946)**  
D207 (3 3/4" long x 7/8" tall)

**\$8.99**



**Seeder and Tractor (1938-1946)**  
D208 (2 3/4" long x 7/8" tall)

**\$8.99**



**2 Tractors (1929-1938)**  
D211 (1 3/8" long x 7/8" tall each)

**\$11.99**



**Service Truck (1914 Diamond T)**  
D217 (3" long x 1 1/2" tall)

**\$11.99**



**Grain Truck (1914 Diamond T)**  
D218 (3" long x 1 1/8" tall)

**\$6.99**



**Motorcycles and Sidecar**  
D228 (1 1/2" diameter x 3/4" tall)

**\$10.99**



**Bulldozer**  
D233 (2 1/4" long x 1 1/8" tall)

**\$10.99**



**Track-Type Loader**  
D235 (2 1/2" long x 1 5/8" tall)

**\$16.99**



**Backhoe - INSLEY Model "K"**  
D237 (3 7/8" long x 1 5/8" tall)

**\$11.99**



**Tank Truck (Diamond T)**  
D242 (2 1/2" long x 1" tall)

**\$15.99**



**Hyster Logging Cruiser and Tractor**  
D246 (4" long x 2" tall)

**\$11.99**



**Dump Truck (1 1/2 Ton Federal)**  
D247 (2 5/8" long x 1 1/2" tall)

**\$10.99**



**Motor Grader**  
D234 (3 1/2" long x 1 1/8" tall)

**\$11.99**



**Flat Bed and Tractor (Diamond T)**  
D244 (3 5/8" long x 1 1/8" tall)

See page 143 for merchandiser. Availability subject to change.



## LANDMARK STRUCTURES™

When you buy Landmark Structures, you buy our trademark commitment to innovation in design and the highest standards in quality you have come to expect from Woodland Scenics. Landmark structures offers a complete spectrum of architecturally accurate building options and includes N, HO and O scale structures.



**Pre-Fab® Landmark Structures** can be assembled in minutes, ready to paint and display. Add roof sections to preassembled walls, paint and attach details, decals and window treatments.



**DPM® Landmark Structures** presents a menu of high quality choices:

- All-inclusive Building Kits, as well as Gold Kits with loads of details
- New DPM Select Building Kits feature the new positive-interlocking prefinished edges along with details, decals and window treatments
- DPM modular systems offer unlimited design options for building structures of any type, size and shape



**Built-&-Ready® Landmark Structures** are hand-painted, highly detailed ready-to-place buildings that include decals and window treatments.



This warning applies to all products on this page.  **WARNING: Choking Hazard! Small parts. Not intended for children under 3 yrs.**

**pre-fab**  
LANDMARK STRUCTURES

**NEW**

## HO Scale Pre-Fab Landmark Structures Building Kits

### Assemble in Minutes...Ready to Paint and Display

Beginner and seasoned modelers can easily assemble these buildings with craftsmanship results. Pre-Fab Building Kits are designed with historic authenticity and built-in character. Add roof sections to the pre-assembled walls and attach details. Includes window detail options and a generous assortment of colorful dry transfer decals to match any paint scheme!



*Buildings*



HO  
NEW

PF5181

\$32.99

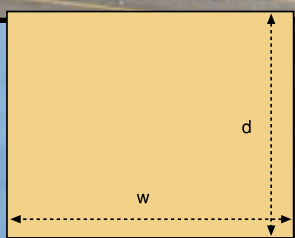

**Planters Feed and Seed Supply**

HO = 4 3/4" w x 3 3/4" d x 4 1/2" h



HO  
NEW

PF5180

\$29.99

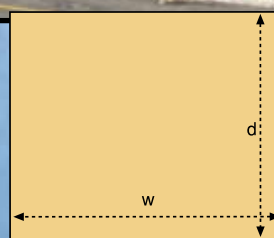

**Fresh Market**

HO = 4 1/2" w x 3 3/4" d x 4 1/8" h



HO  
NEW

PF5182

\$31.99

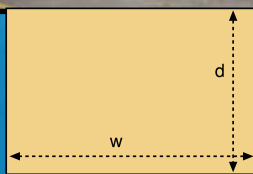

**Main Street Mercantile**

HO = 4 1/8" w x 2 3/4" d x 4 1/8" h



HO  
NEW

PF5183

\$34.99

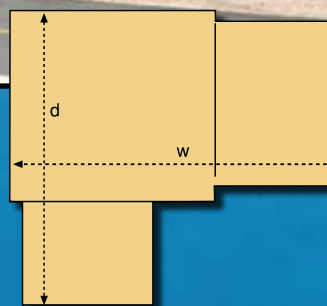

**Sonny's Super Service**

HO = 6" w x 5 3/8" d x 2 5/8" h

**WATCH FOR FUTURE RELEASES!**



This warning applies to all products on this page.



**WARNING:** Choking Hazard! Small parts. Not intended for children under 3 yrs.



*Buildings*

## N and HO Scale Built-&-Ready® Landmark Structures



### From Package to Layout

Built-&-Ready Structures are beautifully hand painted with realistically weathered exteriors, exquisitely authentic details, and include decals and window treatments. These ready-to-place structures are perfect for building cities, towns and villages.

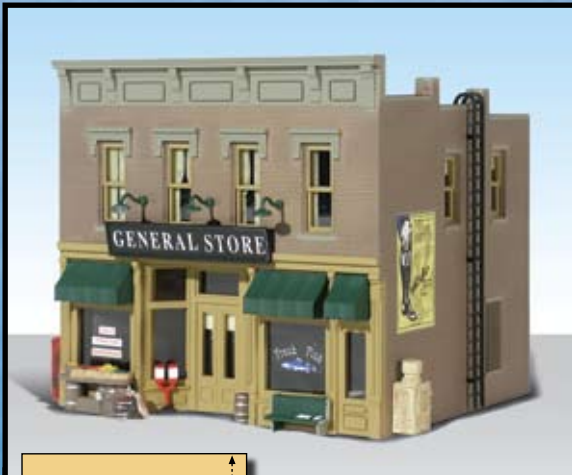

HO N  
NEW

BR5021  
BR4925  
\$54.99  
\$54.99

### Lubener's General Store

HO = 4 1/2" w x 3 3/4" d x 4 1/8" h  
N = 2 7/16" w x 2" d x 2 1/4" h

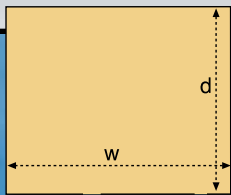

HO N

BR5022  
BR4921  
\$54.99  
\$49.99

### Harrison's Hardware

HO = 4 3/4" w x 3 3/4" d x 4 1/2" h  
N = 3 1/16" w x 2 9/16" d x 2 1/2" h

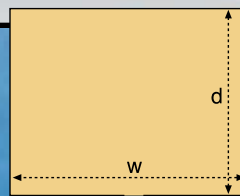

HO N

BR5025  
BR4922  
\$64.99  
\$59.99

### Fill'er Up & Fix'er

HO = 6" w x 5 3/8" d x 2 5/8" h  
N = 3 3/4" w x 3 3/16" d x 1 9/16" h

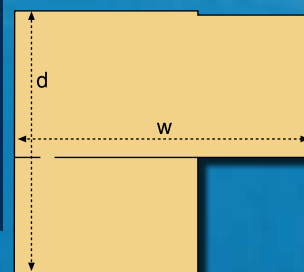

Availability subject to change. Decals and colors may vary from photo.

This warning applies to all products on this page.  **WARNING: Choking Hazard! Small parts. Not intended for children under 3 yrs.**



HO

**Dansbury Depot**

HO = 7 1/2" w x 5 1/8" d x 4" h

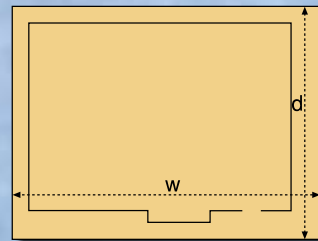

BR5023  
\$64.99



HO

**N**  
**NEW**

**Granny's House**

HO = 5 3/8" w x 4 1/4" d x 3" h  
N = 2 1/16" w x 2 15/32" d x 1 7/16" h

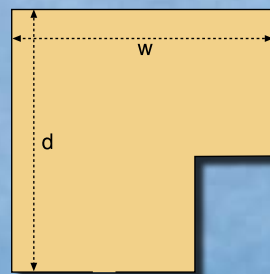

BR5027  
\$59.99

BR4926  
\$64.99



HO

**N**

BR5024  
\$54.99

BR4923  
\$49.99

**Corner Emporium**

HO = 4 1/8" w x 2 3/4" d x 4 1/8" h  
N = 3 1/16" w x 2 3/8" d x 2 9/32" h



HO

BR5028  
\$69.99

**Chip's Ice House**

HO = 6 7/8" w x 5 5/8" d x 4 1/4" h

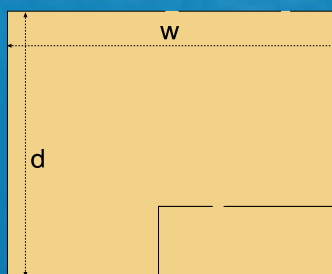

This warning applies to all products on this page.



**WARNING:** Choking Hazard! Small parts. Not intended for children under 3 yrs.



HO

**Drive 'n Dine**

7 3/4" w x 5 5/8" d x 3 15/16" h

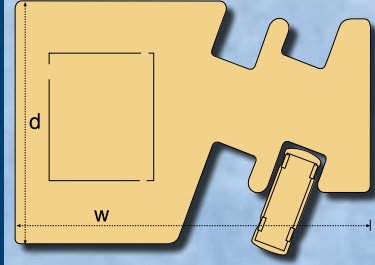

\$89.99 BR5029



HO N

**Clyde & Dale's Barrel Factory**

HO = 6 5/8" w x 5 3/4" d x 4 1/8" h  
N = 4 1/8" w x 3 1/8" d x 3 21/64" h

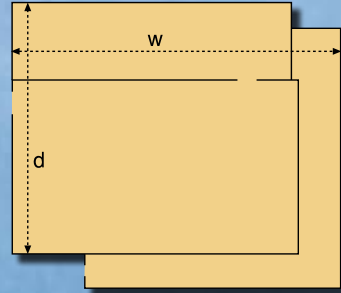

\$74.99 BR5026  
\$69.99 BR4924



HO  
NEW

**Municipal Building**

HO = 8 3/8" w x 5 7/8" d x 4 3/8" h

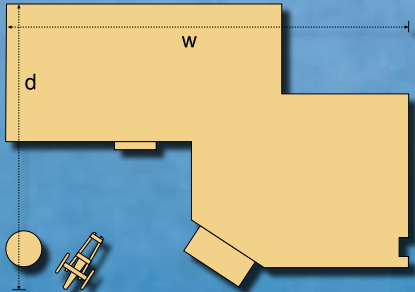

\$74.99 BR5030



HO  
NEW

**Country Store Expansion**

HO = 6 9/16" w x 5 5/8" d x 3 1/8" h

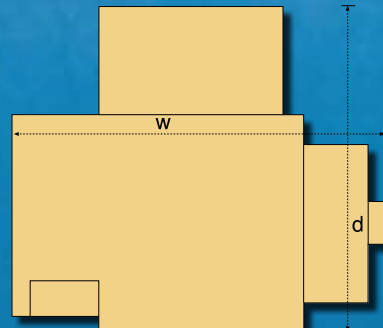

\$69.99 BR5031

*Buildings*

This warning applies to all products on this page.



**WARNING:** Choking Hazard! Small parts. Not intended for children under 3 yrs.

# Buildings



HO  
NEW

BR5032

\$59.99

**J.W. Shoe Cobbler**  
HO = 3" w x 4 5/16" d x 5 5/8" h

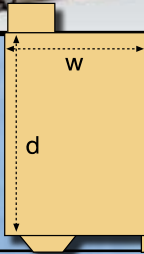

HO  
NEW

BR5033

\$64.99

**Citizens Savings & Loan**

HO = 5 1/8" w x 4 1/8" d x 4 3/4" h

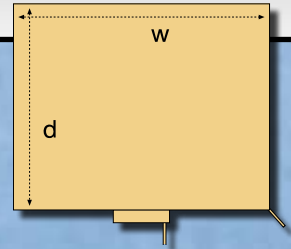

**WATCH FOR FUTURE RELEASES!**

## Design Preservation Models Landmark Structures



Design Preservation Models (DPM) is a line of N, HO and O scale building kits and modular pieces for modelers who want to assemble realistic structures. These high-quality, architecturally accurate models have been specifically researched and developed for the model railroading industry. These kits represent the 19th and 20th Century. The entire line of DPM kits and modular pieces are very easy to assemble and allow modelers total creative freedom to paint, weather and detail as they wish. DPM structures are available in...

- *Select Building Kits* - feature the new positive-interlocking pre-finished edges along with details, decals and window treatments
- *Gold Kits* - themed building packages that include complete buildings, decals, signs and an abundance of details
- *Building Kits* - complete buildings that come with walls, plus roof and window materials
- *Modular System* - unlimited building options with interchangeable wall sections that make it fun and easy to build a structure of any size, shape and height: whatever you want or need for your layout
- *Modular System Designer Bulk Packs* - each features a different architectural style with plans included for three specific buildings

## N Scale Gold Kits

The DPM gold seal signifies our Detailed Editions. These four N scale Gold Kits include highly detailed lead-free metal castings, Dry Transfer Decals and illustrated instructions. They create entire scenes. Look for the full-color packaging with the gold seal.



N

### Night Life

Over 60 details including search light and beer bottle sign  
7" w x 3" d x 2 7/8" h

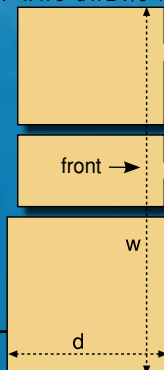

\$62.99 #66300

This warning applies to all products on this page.



**WARNING:** Choking Hazard! Small parts. Not intended for children under 3 yrs.



N  
#66000  
\$69.99

### Woods Furniture Co.

Over 90 details including water tank, sign and fork lift  
11" w x 7" d x 5 7/8" h

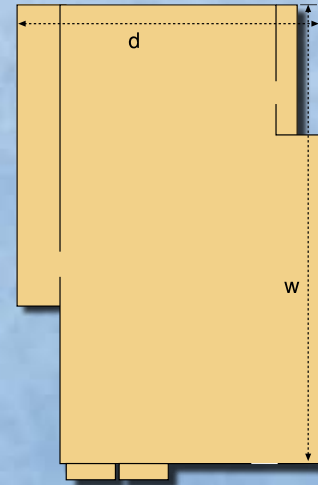

N  
#66100  
\$52.99

### Olsen Feeds & Larsen's Implement

Over 70 details including tractors and combines  
16" w x 9" d x 1 7/8" h

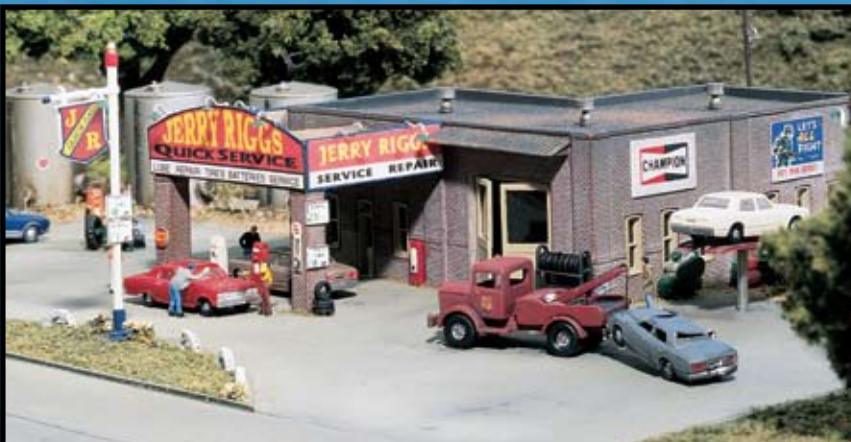
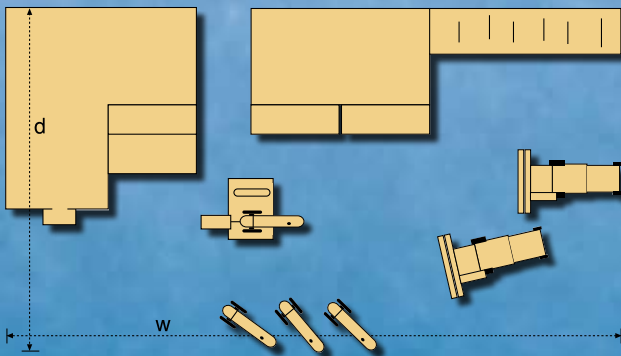

N  
#66200  
\$54.99

### Jerry Riggs Quick Service

Over 130 details including tow truck, lift and gas pumps.  
13 1/2" w x 9" d x 2 1/4" h

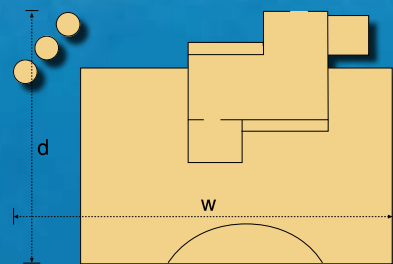

*Buildings*

Some figures and vehicles not included.

This warning applies to all products on this page.  **WARNING: Choking Hazard! Small parts. Not intended for children under 3 yrs.**



## N Scale Building Kits

N Scale Building Kits offer a wide selection of finely detailed buildings with authentic architectural components molded in place for easy assembly. From village shops to manufacturing plants to urban storefronts, we have the N scale buildings you need. Kits contain clear window material and easy-to-follow instructions that include painting and weathering tips.



N

\$13.99 #50100

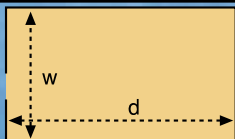

**Bruce's Bakery**  
1 3/4" w x 3" d x 3" h

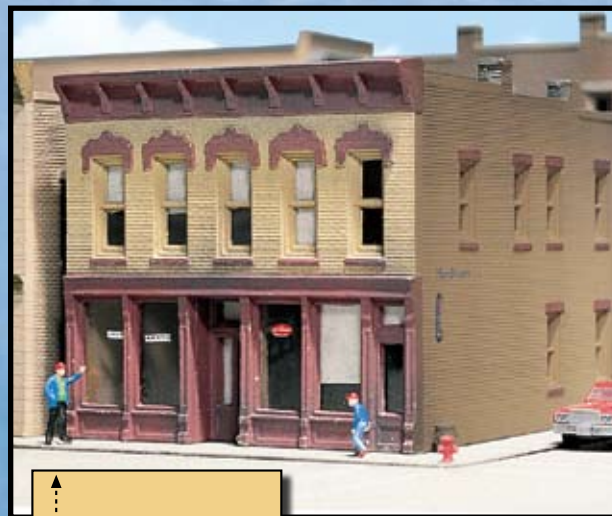

N

\$13.99 #50200

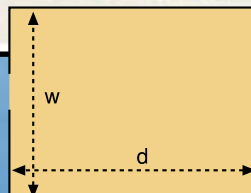

**Hayes Hardware**  
2 1/2" w x 3 1/4" d x 2 1/4" h



N

\$13.99 #50300

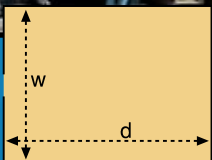

**Otto's Parts**  
2 3/4" w x 3" d x 2 1/2" h



N

\$13.99 #50400

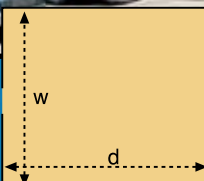

**Char's Soda Shoppe**  
2 5/8" w x 3 1/4" d x 2 1/2" h

Figures, vehicles and decals not included.

This warning applies to all products on this page.



**WARNING:** Choking Hazard! Small parts. Not intended for children under 3 yrs.



N

### Goodnight Mattress Co.

6 1/4" w x 4 3/4" d x 3 3/4" h

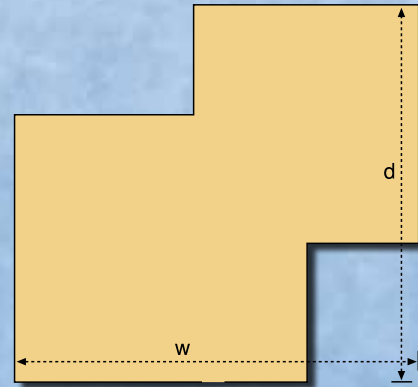

#50500  
\$17.99



N

### Gripp's Luggage Mfg.

7 3/4" w x 4 3/4" d x 2 1/2" h

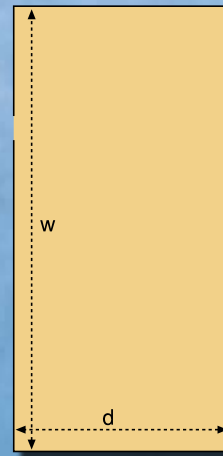

#50600  
\$17.99



N

### Corner Apothecary

3 3/8" w x 1 3/8" d x 3" h

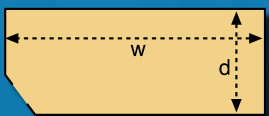

#50700  
\$13.99



N

### Crestone Credit Union

2 7/8" w x 3 1/4" d x 2 1/2" h

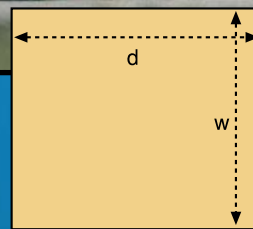

#50800  
\$13.99

*Buildings*

# Buildings



N  
#50900  
\$20.99

**Hilltowne Hotel**

5 1/4" w x 2 1/4" d x 4 5/8" h

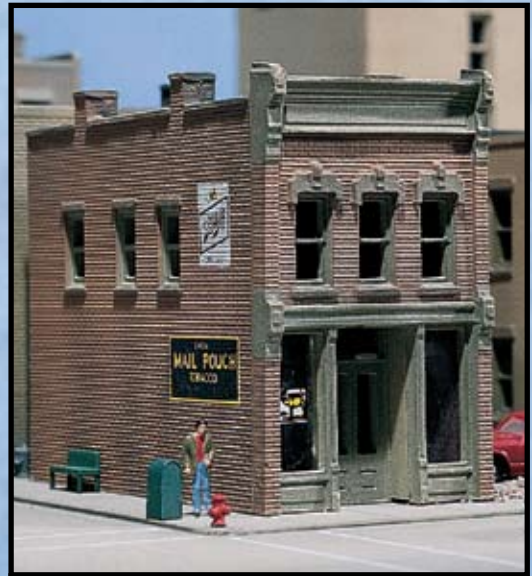
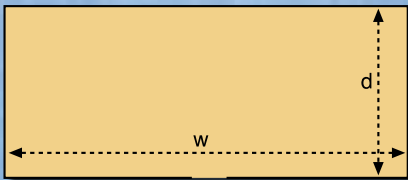

N  
#51100  
\$12.99

**Cricket's Saloon**

1 3/8" w x 2 3/4" d x 2 1/4" h

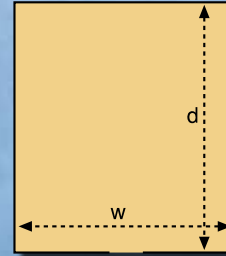

N  
#51300  
\$14.99

**Corner Turret Building**

2" w x 2 7/8" d x 3" h

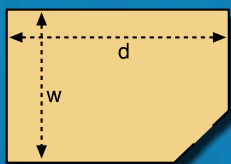

N  
#51500  
\$15.99

**Reed Books**

3 1/4" w x 3" d x 2 3/4" h

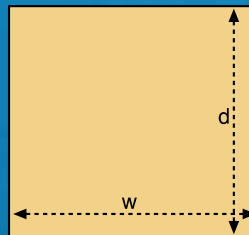



This warning applies to all products on this page.



**WARNING:** Choking Hazard! Small parts. Not intended for children under 3 yrs.



N

\$16.99 #51000

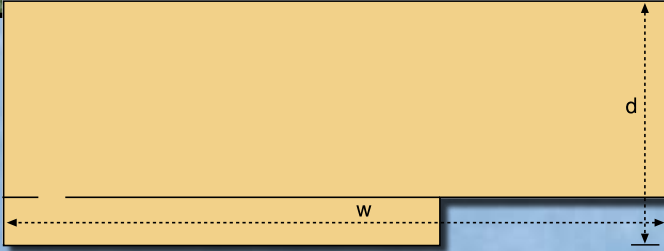

### Trackside Transfer

11 1/2" w x 4 1/4" d x 2 1/4" h



N

\$13.99 #51200

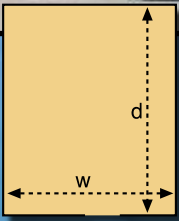

### Roadkill Cafe

2 1/4" w x 2 3/4" d x 2 5/8" h



N

\$14.99 #51400

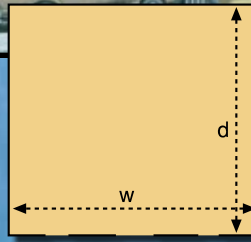

### Erik's Emporium

3 1/4" w x 3" d x 2 5/8" h



N

\$18.99 #51600

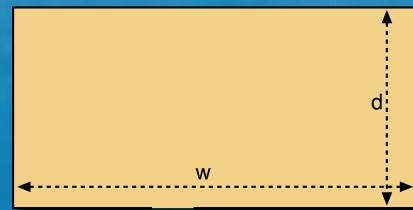

### Wilhelmi's Mercantile

5 1/4" w x 2 5/8" d x 3 3/4" h

*Buildings*

This warning applies to all products on this page.



**WARNING:** Choking Hazard! Small parts. Not intended for children under 3 yrs.

# N Scale Modular System™

## UNLIMITED BUILDING OPTIONS

Interchangeable plastic wall sections make it fun and easy to create buildings of any size, shape or height.

### BUILD AS MANY STORIES AS YOU NEED:

- One-story building - use street or dock level wall sections and cornice
- Two-story building - use street or dock level wall sections, top with one-story wall sections and cornice
- Three-story building - use street or dock level wall sections, top with two-story wall sections and cornice
- More stories - add additional wall sections to create as many stories as desired

Packages include three identical double bay wall sections with pilasters, door, windows and clear window material where needed. All sections are the same color and width (3 1/2"). Cornice packages include nine pieces of cornice with cornice pilasters. Dock riser wall packages include six dock riser wall sections with dock pilasters.

## EASY TO ASSEMBLE

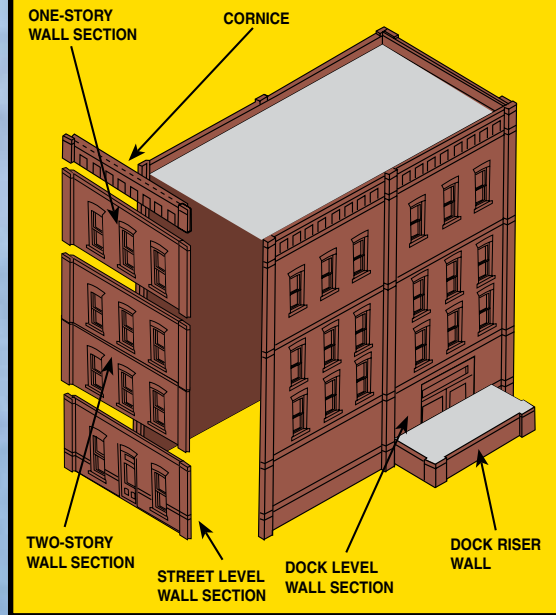

## N Scale

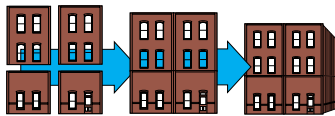

**WALL SECTIONS  
MAKE WALLS.  
WALLS MAKE  
BUILDINGS.**

### ONE-STORY WALL SECTIONS

3 1/2" w x 15/16" h (3 per pkg.)



### CORNICE

(9 per pkg.)

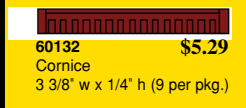

### TWO-STORY WALL SECTIONS

3 1/2" w x 1 13/32" h (3 per pkg.)

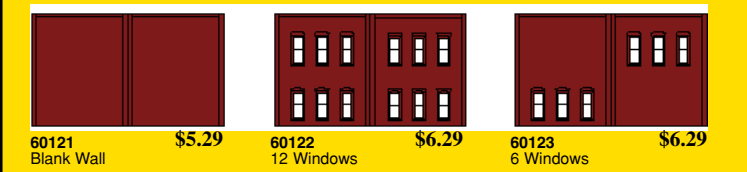

### STREET LEVEL WALL SECTIONS

3 1/2" w x 1 13/32" h (3 per pkg.)

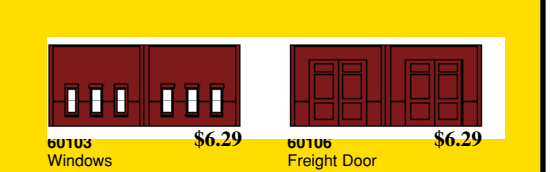

### DOCK LEVEL WALL SECTIONS

3 1/2" w x 1 13/32" h (3 per pkg.)

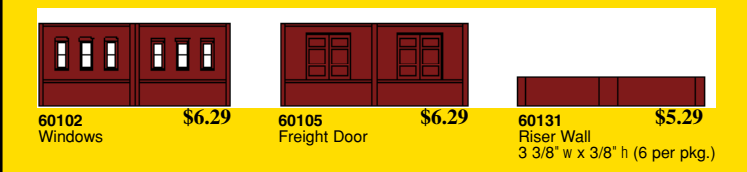

### STREET/DOCK LEVEL WALL SECTIONS

3 1/2" w x 1 13/32" h (3 per pkg.)

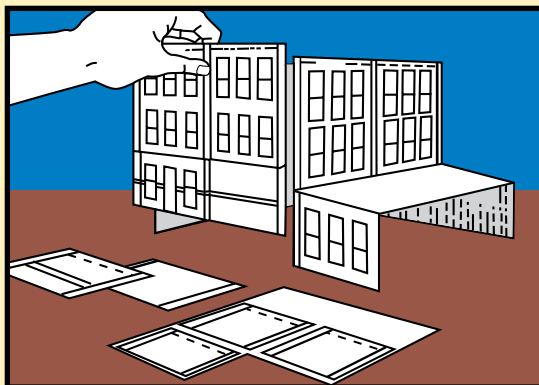
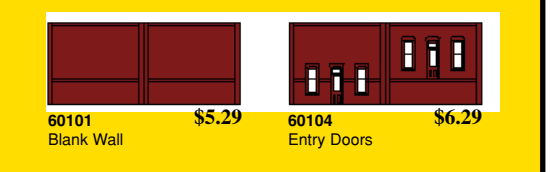

### N Scale Planning Packet #60191

**\$0.99**

Pre-plan buildings with three-dimensional paper mock-ups. The N scale Planning Packet contains full-sized drawings of wall sections. To use, make photocopies of drawings, cut out wall section copies and arrange into paper walls. Tape walls on cardboard. Cut out cardboard and tape together. Modify mock-up until it is satisfactory, then purchase the required wall sections to construct your building.

The N scale Planning Packet is available as a **Free Download** at [www.woodlandscenics.com](http://www.woodlandscenics.com).

This warning applies to all products on this page.



**WARNING:** Choking Hazard! Small parts. Not intended for children under 3 yrs.

## HO Scale Gold Kits

It's all about the details! With an abundance of detailed lead-free, white metal castings and Dry Transfer Decals, DPM Gold Kit buildings create complete layout scenes. Look for the full-color packaging with the gold seal.

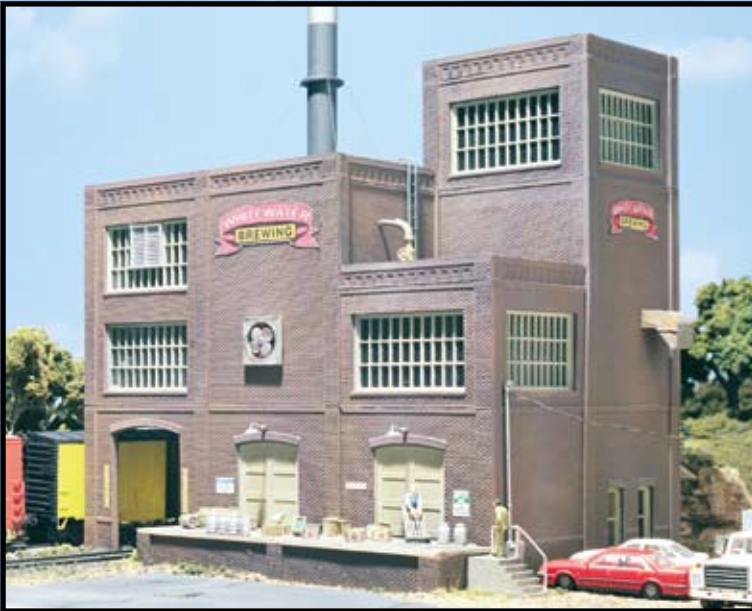

HO

#40200

\$72.99

### Whitewater Brewing

Over 50 details including wooden beer kegs and hand truck  
9 1/2" w x 6" d x 10" h

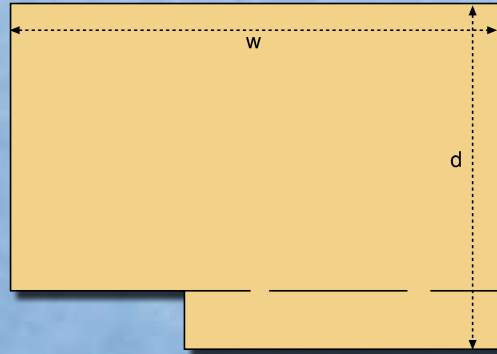

HO

#40100

\$64.99

### Drywell Inks

Over 30 details including storage tank, roof hatches and barrels  
13 3/4" w x 7" d x 5 1/8" h

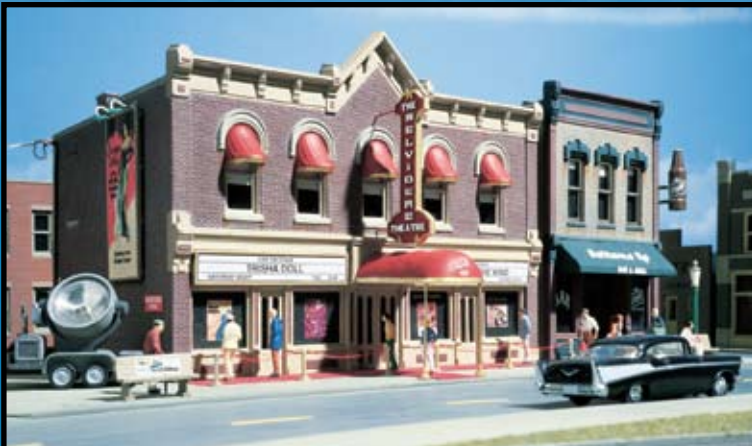
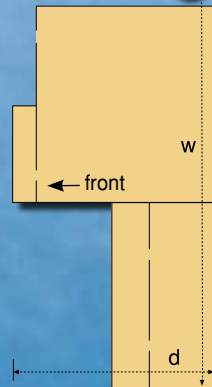

HO

#40300

\$64.99

### Entertainment District

Over 80 details including search light, billboard and stanchions  
9 1/4" w x 5 1/2" d x 4 5/8" h

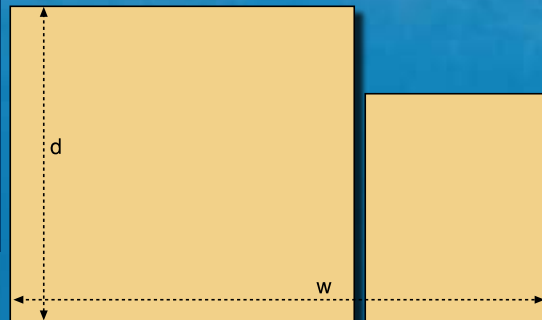

Buildings

This warning applies to all products on this page.



**WARNING: Choking Hazard! Small parts. Not intended for children under 3 yrs.**



HO

### Emery Lane

Over 90 details including motorcycle, street light and mailbox  
12 1/2" w x 8" d x 3" h

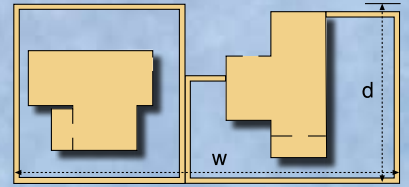

#40400  
\$56.99



HO

### Coal River Passenger & Freight Depot

Over 40 details including trackside clock, crates and freight scale  
15 9/16" w x 6 3/8" d x 3 3/4" h

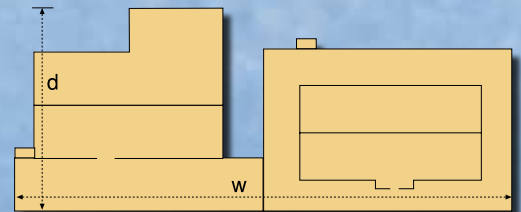

#40500  
\$64.99



HO

### Harlee & Sons Cycle Shop

Over 40 details including motorcycles, junkyard dogs and gas pumps  
6 7/8" w x 11 3/4" d x 2 5/8" h

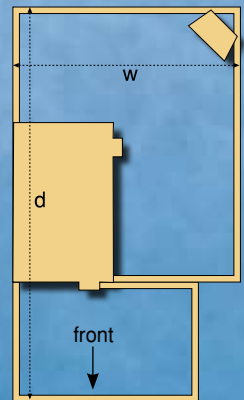

#40600  
\$62.99



HO

### Popa Weelie's Saloon

Over 80 details including 10 motorcycles, billboards and fence  
10 1/2" w x 6" d x 4 1/4" h

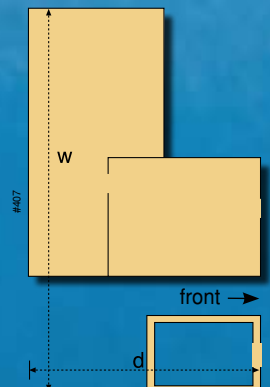

#40700  
\$73.99

This warning applies to all products on this page.



**WARNING:** Choking Hazard! Small parts. Not intended for children under 3 yrs.

## HO Scale Building Kits

With their highly detailed, realistic and authentic design, HO Scale Building Kits are a great way to add structures to your layout. They are easy to assemble and include roofs, clear window materials and fully illustrated instructions with painting suggestions and tips. Once you see how great these DPM buildings look on your layout, you will want to build an entire city.

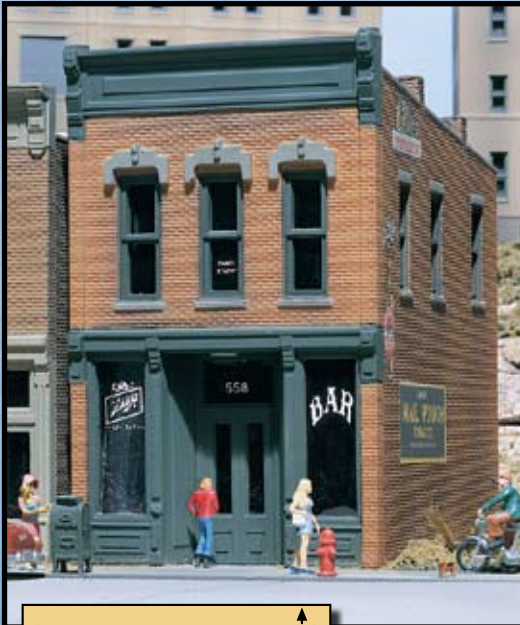

HO

#10100

\$16.99

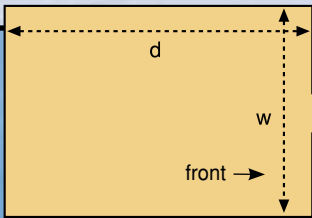

**Kelly's Saloon**  
2 3/4" w x 4" d x 4 7/8" h



HO

#10200

\$16.99

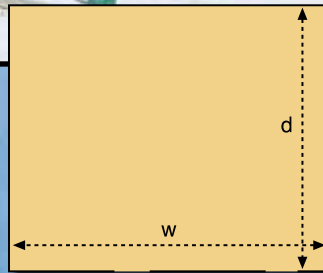

**Robert's Dry Goods**  
4 1/2" w x 3 3/4" d x 4 1/8" h

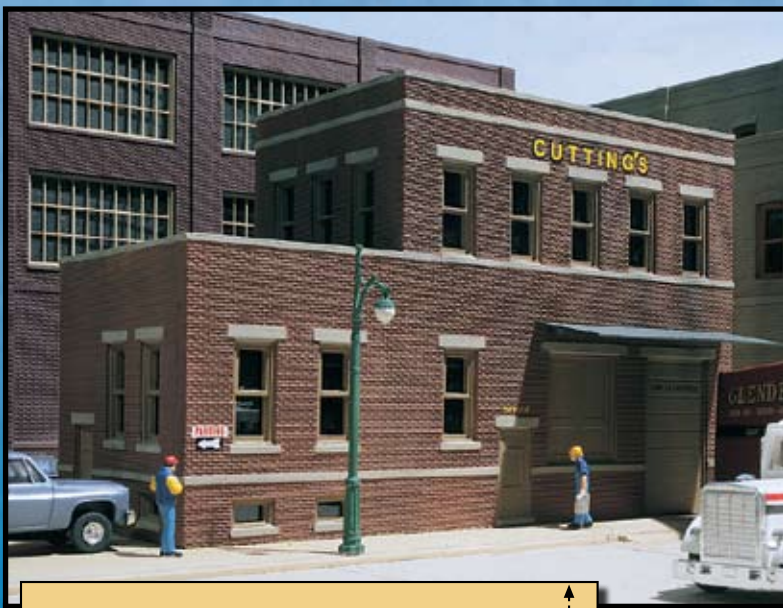

HO

#10300

\$17.99

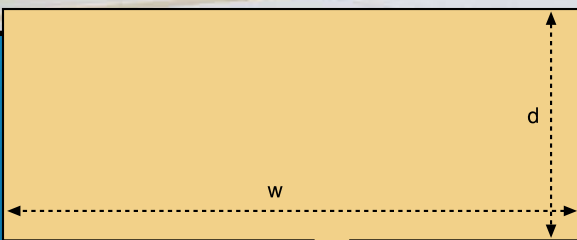

**Cutting's Scissor Co.**  
7 1/4" w x 3" d x 4 5/8" h

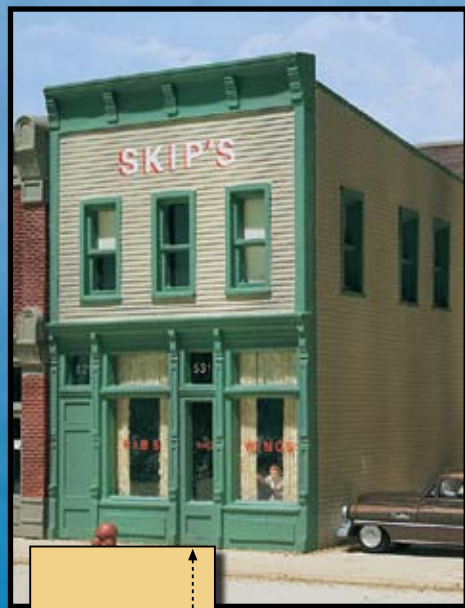

HO

#10500

\$16.99

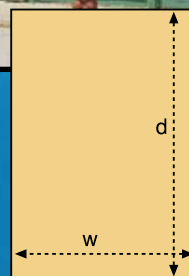

**Skip's Chicken and Ribs**  
2 3/4" w x 4" d x 4 3/8" h

*Buildings*

Figures, vehicles and decals not included.

This warning applies to all products on this page.



**WARNING:** Choking Hazard! Small parts. Not intended for children under 3 yrs.

# Buildings



HO

\$17.99 #10400

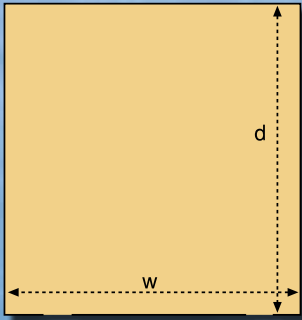

**B. Moore Catalog/Showroom**

4 3/4" w x 5" d x 5" h



HO

\$17.99 #10800

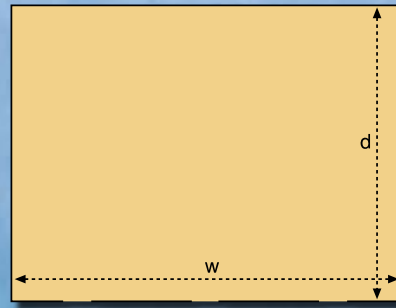

**Goodfellows Hall**

6 1/4" w x 4 3/4" d x 4 5/8" h



HO

\$17.99 #10700

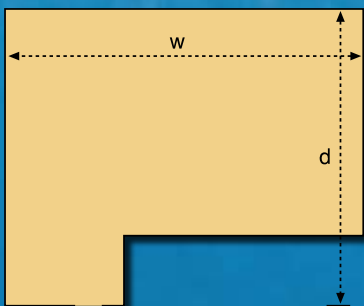

**Freight Depot**

5 3/4" w x 4 3/4" d x 3 1/2" h

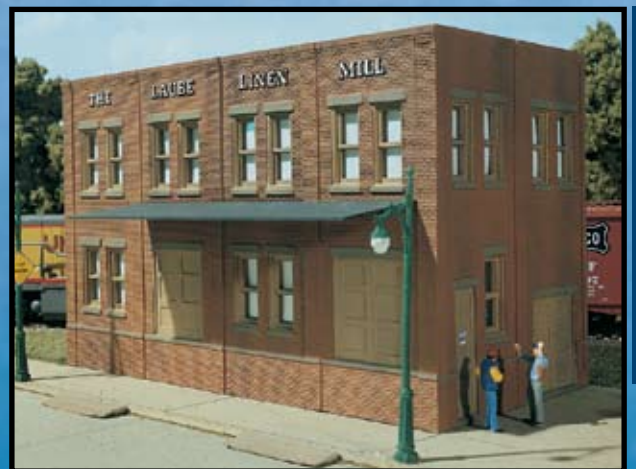

HO

\$17.99 #10600

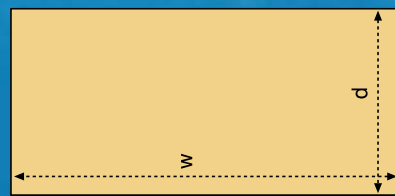

**Laube's Linen Mill**

6 3/4" w x 3 1/4" d x 4 1/4" h

This warning applies to all products on this page.



**WARNING:** Choking Hazard! Small parts. Not intended for children under 3 yrs.

# Buildings



HO

#10900

\$16.99

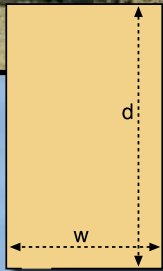

**Townhouse #1**  
2 1/2" w x 4 1/4" d x 4 7/8" h



HO

#11000

\$16.99

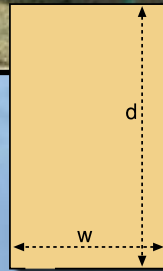

**Townhouse #2**  
2 1/2" w x 4 1/4" d x 4 7/8" h



HO

#11100

\$16.99

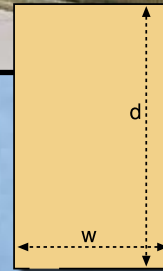

**Townhouse #3**  
2 1/2" w x 4 1/4" d x 4 7/8" h



HO

#11200

\$17.99

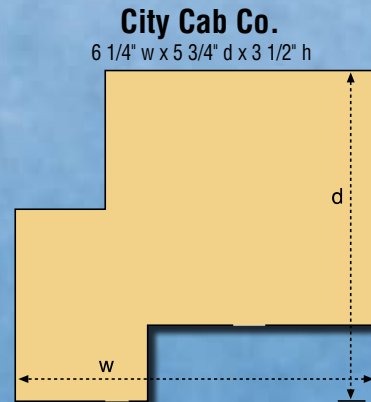

**City Cab Co.**  
6 1/4" w x 5 3/4" d x 3 1/2" h

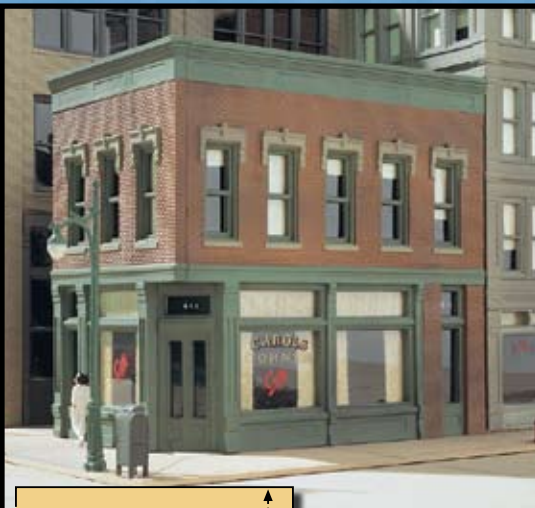

HO

#11300

\$17.99

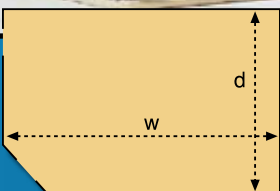

**Carol's Corner Cafe**  
4 1/4" w x 2 3/4" d x 4 1/8" h



HO

#11500

\$17.99

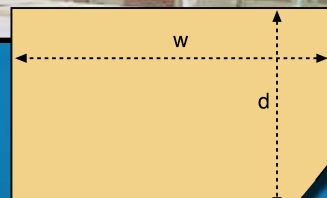

**The Other Corner Cafe**  
4 3/4" w x 3" d x 4 1/4" h

Figures, vehicles and decals not included.

This warning applies to all products on this page.



**WARNING: Choking Hazard!** Small parts. Not intended for children under 3 yrs.

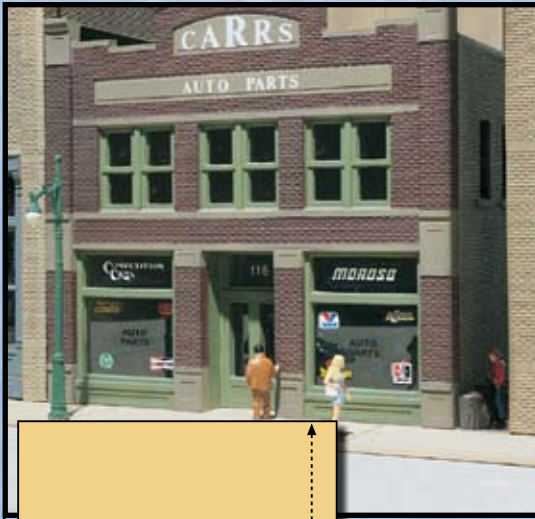

HO

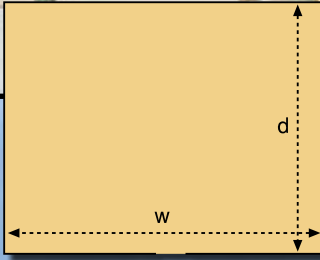

**Carr's Parts**

4 3/4" w x 3 3/4" d x 4 1/2" h

#11600  
\$17.99



HO

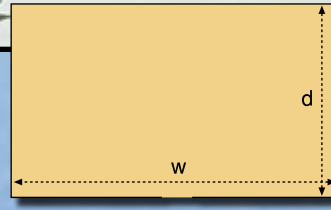

**JC Nickels**

6 3/4" w x 4" d x 4" h

#11700  
\$17.99



HO

**Three Townhouse Flats (Fronts Only)**

2 1/2" w x 4 7/8" h each

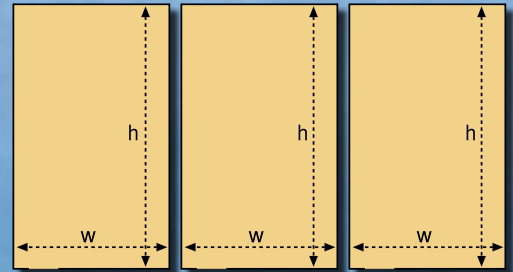

#11400  
\$14.99



HO

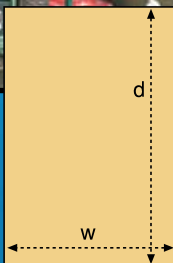

**1st National Bank**

3" w x 4 1/2" d x 5 1/2" h

#11800  
\$17.99



HO

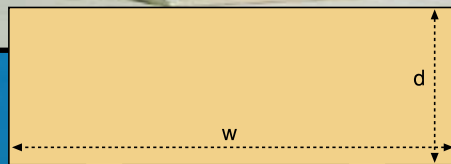

**M.T. Arms Hotel**

7 3/4" w x 2 3/4" d x 6" h

#11900  
\$27.99



This warning applies to all products on this page.



**WARNING:** Choking Hazard! Small parts. Not intended for children under 3 yrs.



HO

#12000

\$17.99

**Front Street Building**

5 3/4" w x 4" d x 4" h

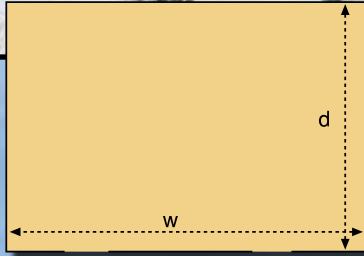

HO

#12100

\$19.99

**Seymour Block**

7" w x 3" d x 4" h

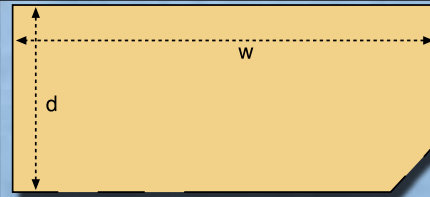

Painting is optional with #200 Series Kits. The walls are one color: the doors and windows another. Kits include walls, windows, doors, roof and clear window material and easy-to-follow, illustrated instructions.

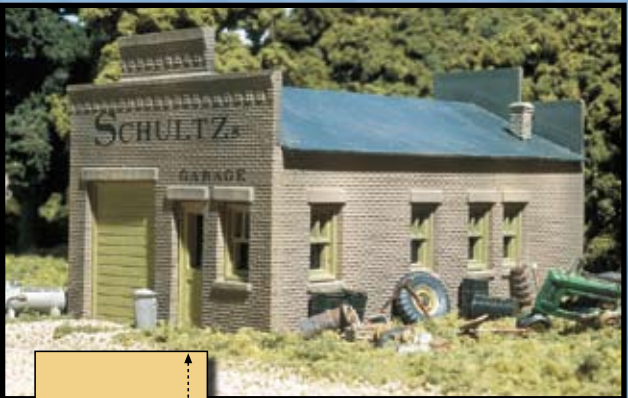

HO

#20100

\$17.99

**Schultz's Garage**

3" w x 4 3/4" d x 2 3/4" h

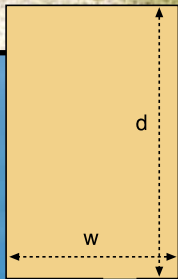

HO

#20300

\$17.99

**C. Smith Packing House**

4 3/4" w x 5 3/8" d x 3 3/4" h

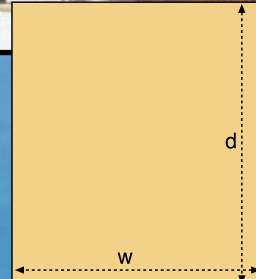

HO

#20200

\$16.99

**Pam's Pet Shop**

2 1/8" w x 3" d x 4 1/8" h

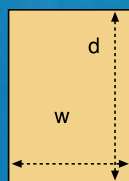

HO

#20400

\$16.99

**Walker Building**

3" w x 4 1/4" d x 6" h

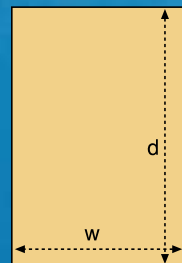

# Buildings

Figures, vehicles and decals not included.

This warning applies to all products on this page.  **WARNING: Choking Hazard! Small parts. Not intended for children under 3 yrs.**



**NEW**

## HO Scale Select Building Kits

DPM Select Building Kits are unique works of art designed by an architect and infused with period-authentic detailed realism. They feature state of the art, positive-interlocking pre-finished edges for a quicker, more accurate assembly.



**HO  
NEW**

**\$37.99 #12200**

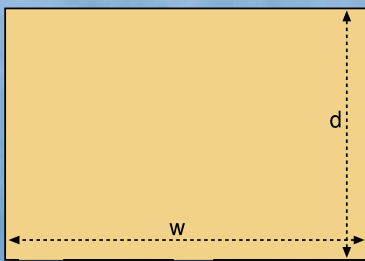

**First Bank**  
5 1/8" w x 4 1/8" d x 4 3/4" h



**HO  
NEW**

**\$34.99 #12300**



rear view

**Stone Bakery**  
3" w x 4 5/16" d x 5 5/8" h

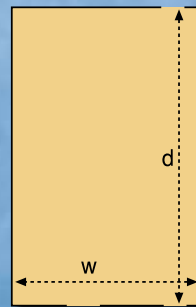

**WATCH FOR FUTURE RELEASES!**

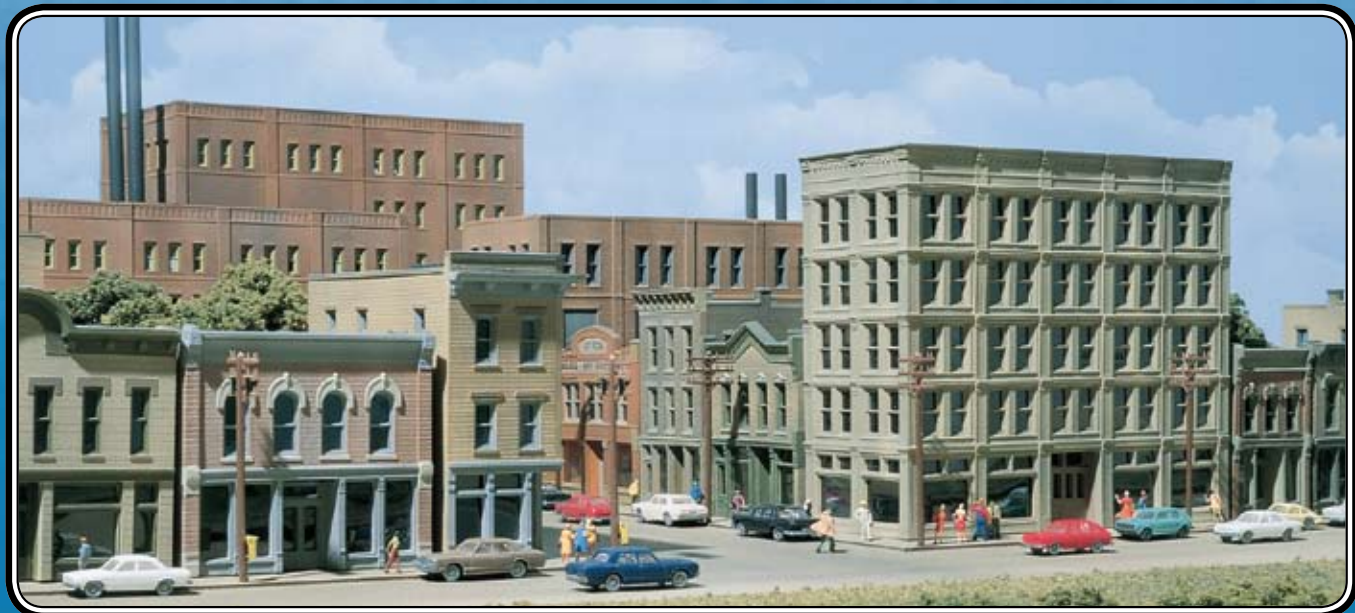

This warning applies to all products on this page. **WARNING: Choking Hazard! Small parts. Not intended for children under 3 yrs.**

# HO Scale Modular System

## UNLIMITED BUILDING OPTIONS

Interchangeable plastic wall sections make it fun and easy to create buildings of any size, shape or height. Use plastic model cement or solvent.

## BUILD AS MANY STORIES AS YOU NEED:

- One-story building - use street or dock level wall sections and cornice
- Two-story building - use street or dock level wall sections, top with one-story wall sections and cornice
- Three-story building - use street or dock level wall sections, top with two-story wall sections and cornice
- More stories - add additional wall sections to create as many stories as desired

Packages include four identical double bay wall sections with pilasters, door, windows and clear window material where needed. All sections are the same color and width (2 3/4"). Cornice packages include eight pieces of cornice with cornice pilasters. Dock riser wall packages include eight dock riser wall sections with dock pilasters.

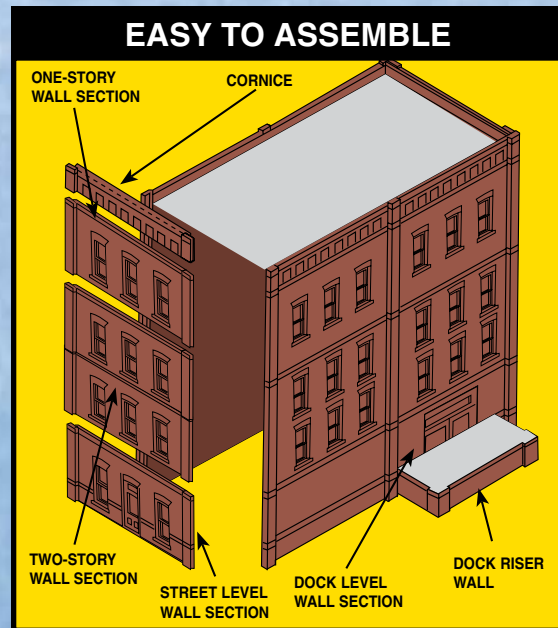
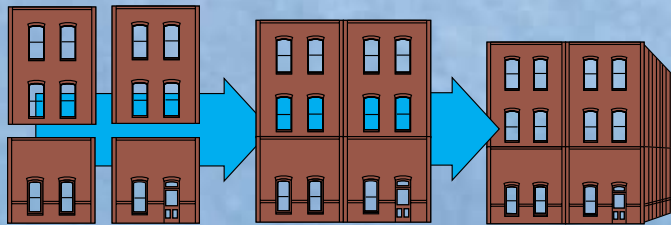

**WALL SECTIONS MAKE WALLS.  
WALLS MAKE BUILDINGS.**





Buildings

## HO Scale

### ONE-STORY WALL SECTIONS 2 3/4" w x 1 7/8" h (4 per pkg.)

 <b>30112</b> Arched Window \$7.29	 <b>30130</b> Rectangular Window \$7.29	 <b>30147</b> Victorian Window \$7.29
 <b>30167</b> 20th Century Window \$7.29	 <b>30175</b> Steel Sash Window \$7.29	 <b>30113</b> Blank Wall \$6.29











### TWO-STORY WALL SECTIONS 2 3/4" w x 3 11/16" h (4 per pkg.)

 <b>30108</b> Arched 4 Window \$7.29	 <b>30109</b> Arched 2 Window (High) \$7.29	 <b>30110</b> Arched 2 Window (Low) \$7.29	 <b>30138</b> Rectangular 4 Window \$7.29	 <b>30139</b> Rectangular 2 Window (High) \$7.29
 <b>30137</b> Rectangular 2 Window (Low) \$7.29	 <b>30144</b> Victorian Window \$7.29	 <b>30164</b> 20th Century Window \$7.29	 <b>30174</b> Steel Sash Window \$7.29	 <b>30111</b> Blank Wall \$6.29













### CORNICE (8 per pkg.)

 <b>30114</b> Cornice Fancy 2 3/4" w x 3/8" h \$6.29
 <b>30117</b> Cornice Plain 2 3/4" w x 5/16" h \$6.29

### STREET LEVEL WALL SECTIONS 2 3/4" w x 2 3/4" h (4 per pkg.)

 <b>30101</b> Arched Entry \$7.29	 <b>30131</b> Rect. Entry \$7.29	 <b>30134</b> Rect. Window \$7.29	 <b>30141</b> Victorian Entry \$7.29
 <b>30142</b> Victorian Window \$7.29	 <b>30161</b> 20th Century Entry \$7.29	 <b>30162</b> 20th Century Window \$7.29	 <b>30171</b> Steel Sash Entry \$7.29
 <b>30102</b> Freight Door \$7.29	 <b>30132</b> Overhead Door \$7.29	 <b>30107</b> Open Arch \$6.29	 <b>30104</b> Blank Wall \$6.29

### DOCK LEVEL WALL SECTIONS 2 3/4" w x 2 3/4" h (4 per pkg.)

 <b>30105</b> Arched Entry \$7.29	 <b>30103</b> Arched Wndw. \$7.29	 <b>30136</b> Rect. Entry \$7.29	 <b>30133</b> Rect. Window \$7.29
 <b>30143</b> Victorian Window \$7.29	 <b>30163</b> 20th Century Window \$7.29	 <b>30172</b> Steel Sash Entry \$7.29	 <b>30173</b> Steel Sash Window \$7.29
 <b>30106</b> Freight Door \$7.29	 <b>30135</b> Overhead Door \$7.29	 <b>30115</b> Dock Riser Wall 2 3/4" w x 9/16" h (8 per pkg.) \$6.29	 <b>30104</b> Blank Wall \$6.29

### POWERHOUSE WINDOW

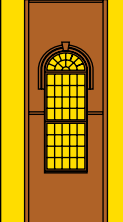
 <b>30118</b> Powerhouse Window 2 3/4" w x 7 3/8" h (2 per pkg.) \$7.29
---

This warning applies to all products on this page.



**WARNING:** Choking Hazard! Small parts. Not intended for children under 3 yrs.

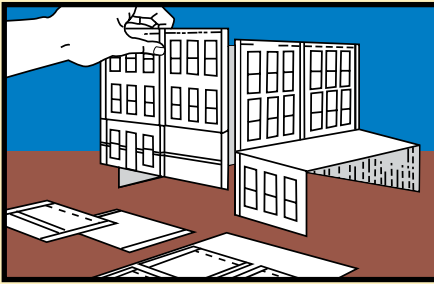

### HO Scale Planning Packet #30191

\$1.99

Pre-plan buildings with three-dimensional paper mock-ups. The HO scale Planning Packet contains full-sized drawings of wall sections. To use, make photocopies of drawings, cut out the wall section copies you want and arrange into paper walls. Tape walls on cardboard. Cut out cardboard and tape together. Modify mock-up until it is satisfactory, then purchase the required wall sections to construct your building.

The HO scale Planning Packet is available as a **Free Download** at [www.woodlandscenics.com](http://www.woodlandscenics.com).

## HO Scale Modular Option Packs

Each pack contains a variety of wall section quantities, styles and suggested building options. You can add to these kits from your dealer's stock of Modular System parts to create an even larger structure!

\$36.99

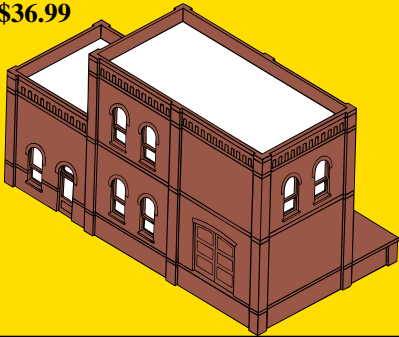

**3-in-1 Modular Kit #35100**  
120 pieces (approx. 8 1/2" w x 6" d x 5" h)

\$44.99

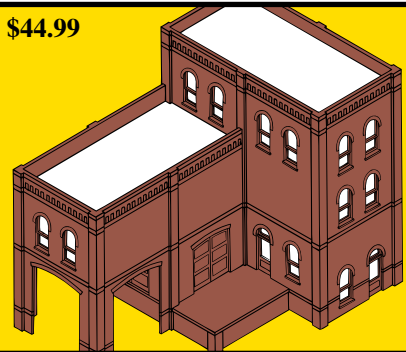

**4-in-1 Modular Kit #35200**  
175 pieces (approx. 7 1/2" w x 8 1/2" d x 7" h)

\$52.99

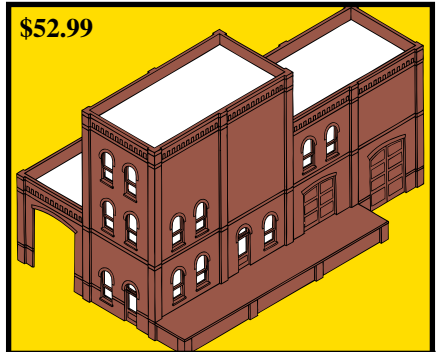

**4-in-1 Modular Kit #35300**  
213 pieces (approx. 8 1/2" w x 11 1/2" d x 7" h)



### Roof and Trim Kit #30190

\$6.29

This kit provides styrene plastic roof material, brick parapet wall trim strips and styrene plastic inside corner strips for modular buildings of your own design. Assorted roof vents and hatches for all buildings are included. Parts are plastic and add fine detail and realism to buildings.

**Assorted Roof Vents**  
(8 total)

**Assorted Hatches**  
(5 total)

**Parapet Wall Trim**  
(9 pieces = 49 1/2")

Also includes: two sheets styrene plastic roof material (6" x 8 1/2" each), two strips styrene plastic inside corner strips.

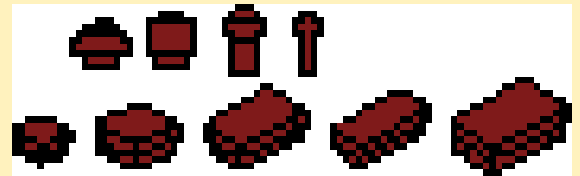

### HO Scale Modular Learning Kit #36000

\$12.99

Learn the skills needed to build any of DPM's modular buildings. This fun and easy Learning Kit includes the planning packet, complete instructions and everything necessary to construct a finely detailed building to use in a variety of ways on your HO layout. Dry Transfer Decals, roof and clear window materials included.

5 3/4" w x 3" d x 3" h

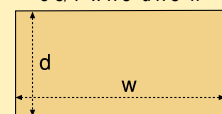

Figures and vehicles not included.

This warning applies to all products on this page.



**WARNING:** Choking Hazard! Small parts. Not intended for children under 3 yrs.

## HO Scale Modular Building Kits

Construct these three highly detailed industrial buildings as illustrated, or customize by expanding their design with additional DPM modular parts. Easy to build, these kits include injection molded styrene plastic modular parts, roof, clear window materials and complete instructions.



HO

### Fedups Freight Co.

A shipping and receiving center for an action-oriented focal point  
19 3/4" w x 8 3/4" d x 6 3/4" h

#35400

\$54.99

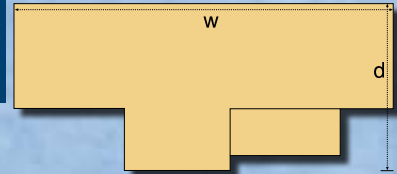

HO

#35500

\$54.99

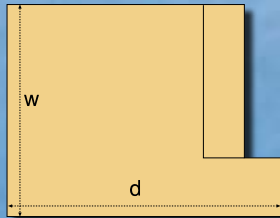

### Tera Surplus Window Warehouse

A big industrial/warehouse structure with high profile  
8 3/4" w x 11 1/2" d x 12 1/2" h



HO

#35600

\$54.99

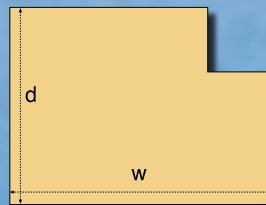

### Powerhouse

A large and impressive industrial structure with dramatic three-story windows  
11 1/4" w x 5 3/4" d x 10 1/2" h

## HO Scale Modular System Designer Bulk Packs

Each Designer Bulk Pack features a different architectural style with plans to build three specific structures. Everything is included: all the plastic styrene modular parts, roof and clear window materials, complete instructions, building plans, plus painting and weathering tips. You can expand any of the three building designs by adding additional wall sections (HO Scale Modular Parts on page 83), or use the Packs as an economical way to purchase modular parts for your own designs. You'll save about 40% by purchasing the packs than if you purchased the same wall sections separately.

Build paper mock-ups with the Planning Packet included in the Designer Bulk Packs, and simply design exactly the structure you want. By combining different modular elements of the Designer Bulk Packs and the more than 40 available interchangeable wall sections, you can fabricate a building of any size or shape. The possibilities are virtually limitless.



11 5/16" w x 8 9/16" d x 6 3/4" h



14 1/16" w x 5 3/16" d x 6 3/4" h



11 5/16" w x 8 9/16" d x 6 3/4" h

HO

#36100

\$52.99

### Arched Window Industrial Building

Designed for urban factory, warehouse or institutional usage, the Arched Window Industrial Buildings feature classic architectural lines that fit well with any skyline.

*Buildings*

Figures, vehicles and decals not included.

This warning applies to all products on this page.  **WARNING: Choking Hazard! Small parts. Not intended for children under 3 yrs.**



4 11/16" w x 3 1/16" d x 6 3/4" h



8 9/16" w x 8 9/16" d x 8 5/8" h



11 5/16" w x 5 13/16" d x 6 3/4" h

HO  
#36200  
\$52.99

### Rectangular Window Industrial Building

Rectangular Window Industrial Buildings premiered in the late 1800s. Popular as factories, warehouses and institutional buildings, they maintain their profiles in cities and towns today.



8 9/16" w x 8 9/16" d x 8 5/8" h



11 5/16" w x 5 13/16" d x 8 5/8" h



11 5/16" w x 5 13/16" d x 6 3/4" h

HO  
#36300  
\$52.99

### Victorian Style Storefront Building

Victorian Style Storefront Buildings characterize the ornate style of the 19th Century. Retail stores commonly occupy the street level, while the upper floors function as offices, showrooms and department stores.



11 5/16" w x 5 13/16" d x 8 5/8" h



8 9/16" w x 5 13/16" d x 10 1/2" h



8 9/16" w x 5 13/16" d x 10 1/2" h

HO  
#36400  
\$52.99

### Twentieth Century Storefront Building

Twentieth Century Storefront Buildings enhance the marketplace with dignified style. The upper floors accommodate offices, showrooms and financial institutions, while large display windows at street level attract customers to the retail activity within.



11 5/16" w x 5 13/16" d x 8 5/8" h



11 5/16" w x 5 13/16" d x 8 5/8" h

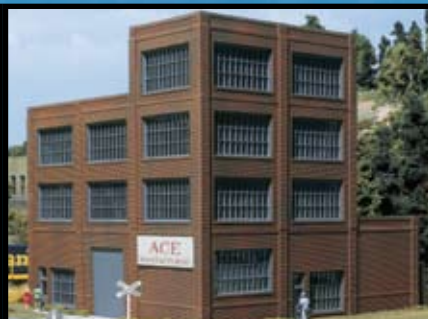

8 9/16" w x 8 9/16" d x 8 5/8" h

HO  
#36500  
\$52.99

### Steel Sash Window Industrial Building

Steel Sash Window Industrial Buildings gained popularity early in the 20th Century. Larger windows provide energy-conserving light to the workplace, while multiple panes of glass, supported by steel framework, create an open feeling.

Figures, vehicles and decals not included.

This warning applies to all products on this page.



**WARNING:** Choking Hazard! Small parts. Not intended for children under 3 yrs.

## 0 Scale Building Kits

These three beautiful and easy to assemble building kits are individually hand-cast in high-quality tooling resin with architectural details molded in place. Roof and clear window material and complete instructions are included.



0 #80100 \$89.99

**Birdie's Tavern**  
4 1/4" w x 6 3/4" d x 7" h

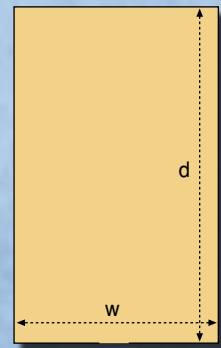

0 #80200 \$94.99

**Kirsten's Corner Cafe**  
8 3/4" w x 6 1/4" d x 6 3/4" h

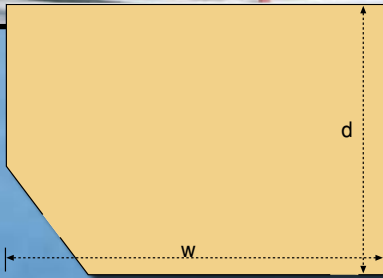

0 #80300 \$94.99

**Aunt Eleanore's House**  
5 3/4" w x 6" d x 5 1/4" h

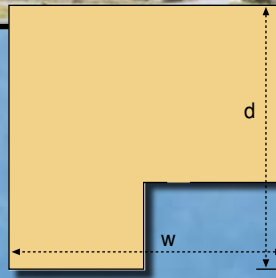

## 0 Scale Modular System

### UNLIMITED BUILDING OPTIONS

Interchangeable plastic wall sections make it easy to create buildings of any size, shape or height, according to your layout needs. Build large or small 0 scale buildings with architectural details molded in place. All wall sections are uniform in height and width (3 1/16" w x 4 1/8" h). Build two, three or more stories by stacking the desired number of wall sections. When you reach the desired height, finish the building with cornices.

### BUILD AS MANY STORIES AS YOU NEED:

- Two identical walls with pilasters, plus clear window material
- Dock riser wall packages include four dock riser walls with pilaster
- Cornice packages include eight pieces of cornice with cornice pilaster
- Complete instructions

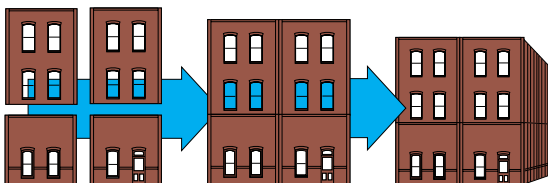

**WALL SECTIONS  
MAKE WALLS.  
WALLS MAKE  
BUILDINGS.**

### EASY TO ASSEMBLE

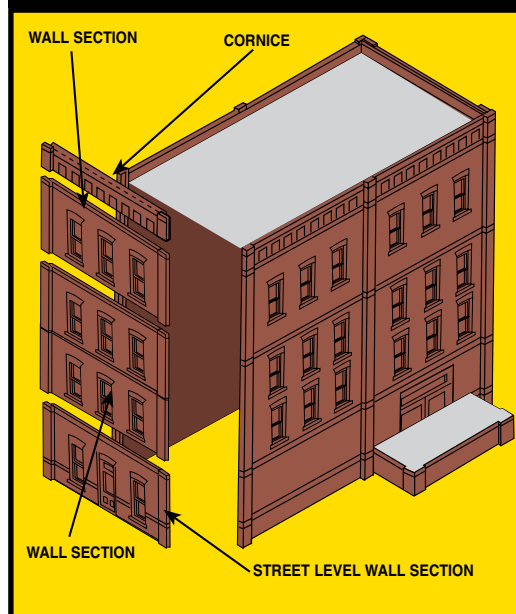

*Buildings*

This warning applies to all products on this page.



**WARNING:** Choking Hazard! Small parts. Not intended for children under 3 yrs.

## O Scale

### WALL SECTIONS

4 1/8" w x 3 1/16" h (2 per pkg.)

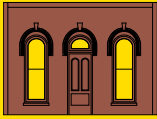

**90101**  
Street/Dock Level  
Arched Entry  
\$7.99

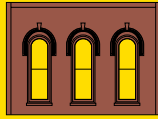

**90102**  
Arched Window  
\$7.99



**90103**  
Blank Wall  
\$7.99



**90104**  
Street/Dock Level  
Rectangular Entry  
\$7.99



**90105**  
Rectangular Window  
\$7.99



**90106**  
Double Rectangular  
Window  
\$7.99



**90107**  
Street/Dock Level  
Freight Door  
\$7.99



**90108**  
Dock Riser Wall  
4 1/8" w x 1 1/4" h  
(4 per pkg.)  
\$7.99



**90109**  
Cornice  
4 1/8" w x 1/2" h  
(8 per pkg.)  
\$7.99

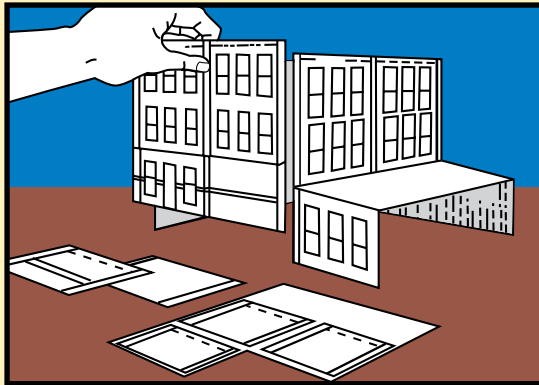

### O Scale Planning Packet #90191

**\$0.99**

Pre-plan buildings with three-dimensional paper mock-ups. The O scale Planning Packet contains full-sized drawings of wall sections. To use, make photocopies of drawings, cut out the wall section copies you want and arrange into paper walls. Tape walls on cardboard. Cut out cardboard and tape together. Modify mock-up until it is satisfactory, then purchase the required wall sections to construct your building.

The O scale Planning Packet is available as a **Free Download** at [www.woodlandscenics.com](http://www.woodlandscenics.com).

## O Scale Modular Building Kits

Add authenticity and realism to your layout with these highly detailed, easy to assemble O scale building kits. Modular parts are made of injected molded styrene plastic and kits include roof, clear window material and complete instructions.



O

#95100  
\$44.99

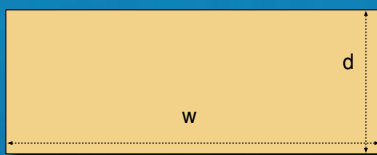

**Heier Kite Co.**  
13" w x 4 1/2" d x 6 1/2" h



O

#95200  
\$62.99

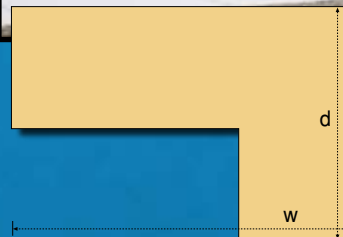

**Konrad Paint Co.**  
12 3/4" w x 8 3/4" d x 6 1/2" h



This warning applies to all products on this page.



**WARNING:** Choking Hazard! Small parts. Not intended for children under 3 yrs.

## Woodland Scenics Building Sets

Each of these building sets contain a collection of individual, architecturally accurate building kits that are a perfect complement to any layout! They include loads of detailed, lead-free, metal accessories and Dry Transfer Decals. Each building set is a complete city in a box at a super value!

### City & Industry Building Set S1486

\$229.99

- Complements Grand Valley Layout Kit or any HO scale layout
- A complete city in a box
- Fifteen HO scale building kits
- Buildings feature molded-in, architectural details
- More than 160 detailed accessories and 130 Dry Transfer Decals
- Super value - saves money over items purchased separately



### River Pass

### Building Kits S1487 \$229.99

This building set is a collection of 15 structures, created with authenticity and fine detail. All the necessary detailed accessories and Dry Transfer Decals are included to detail the buildings on your layout. Use the included River Pass street plan or use an existing layout and create your own HO scale plan. The set includes:

- More than 200 detailed accessories
- 110 Dry Transfer Decals
- 20 signs and posters



### Town and Factory Building Set S1485

\$134.99

- Complements Scenic Ridge Layout Kit or any N scale layout
- Thirteen N scale building kits
- Buildings feature molded-in, architectural detail
- More than 70 detailed accessories and 60 Dry Transfer Decals
- Super value - saves money over items purchased separately



## Scenic Details®

These kits are finely crafted HO scale reproductions made with highly detailed lead-free metal castings. Scenic Details are economical, easy to assemble, fun to paint and they add color, interest and authenticity to any layout. To ensure proper placement, add Scenic Details once landscaping is complete. Colorful Dry Transfer Decals are included in some of the kits. Attach to layout with Scenic Accents Glue, Hob-e-Tac Adhesive or Scenic Glue. We recommend using super glue or a two-part epoxy to assemble Scenic Details. Painting with Mini-Scene Paint Set (page 91) is recommended.



\$10.99



### Smokehouse

D213 (2 1/2" diameter x 1 3/8" tall)

\$11.99



### 3 Outhouses and Man

D214 (2 1/2" diameter x 1 3/8" tall)

\$11.99



### Chicken Coop

D215 (2 1/2" diameter x 1" tall)

Scenic Details, Mini-Scene, Complete Scenes and Trackside Scenes all contain lead-free metal castings that are loaded with details and easy to assemble. First clean castings, then glue pieces according to included diagrams and instructions using super glue or two-part epoxy. Let glue dry and paint.

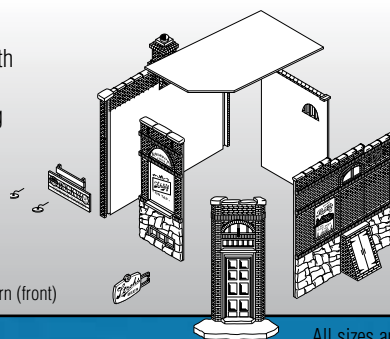

D238 Rocky's Tavern (front)

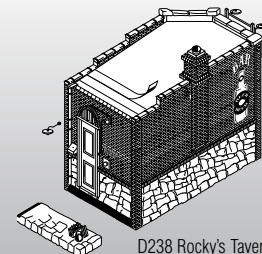

D238 Rocky's Tavern (back)

All sizes are approximate. See page 143 for merchandiser.

This warning applies to all products on this page.  **WARNING: Choking Hazard! Small parts. Not intended for children under 3 yrs.**

\$10.99



**Tool Shed**

D216 (2 1/2" diameter x 2 1/2" tall)

\$19.99

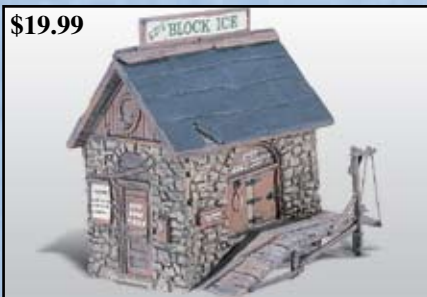

**Ice House**

D219 (2 3/8" long x 2 1/2" tall)

\$24.99

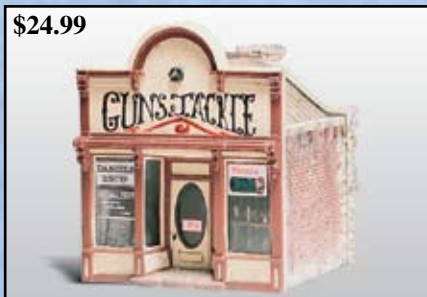

**Daniels Outfitters**

D220 (2 1/4" long x 2 5/8" tall)

\$19.99



**Pharmacy**

D221 (3 1/4" long x 3 3/4" tall)

\$18.99



**Ticket Office**

D222 (2 1/4" long x 2 1/2" tall)

\$19.99



**Gas Station**

D223 (4" diameter x 2 7/8" tall)

\$19.99



**Doctor's Office and Shoe Repair**

D224 (3" long x 2 1/8" tall)

\$10.99



**Gazebo**

D236 (1 1/2" diameter x 2 1/4" tall)

\$22.99



**Rocky's Tavern**

D238 (3 1/8" long x 2 1/4" tall)

\$24.99



**Flag Depot**

D239 (4 1/4" long x 2" tall)

\$24.99



**Tucker Brothers Machine Shop**

D240 (3 3/8" long x 2 3/8" tall)

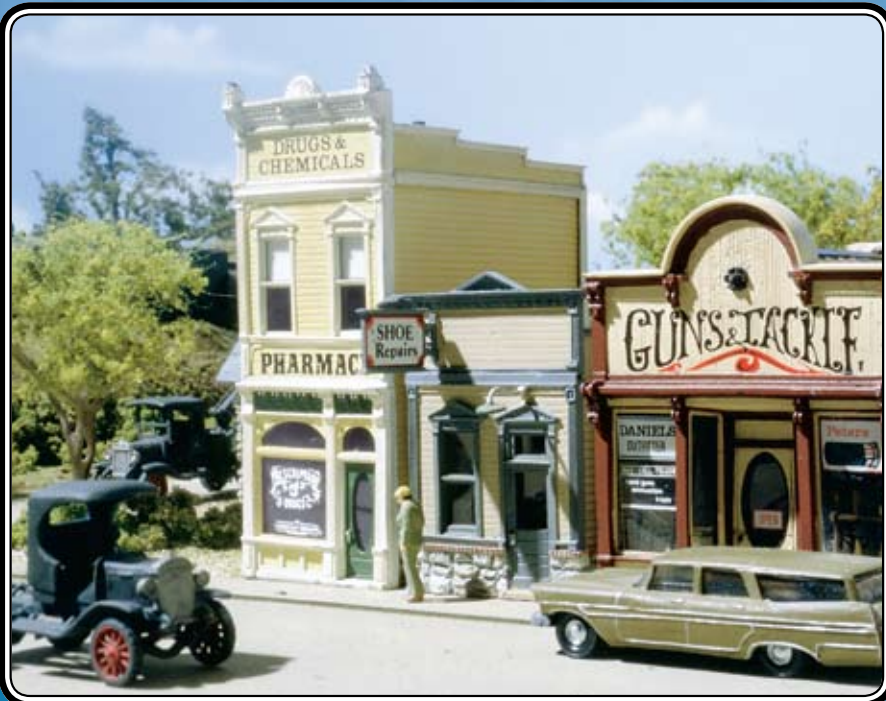

This warning applies to all products on this page.



**WARNING:** Choking Hazard! Small parts. Not intended for children under 3 yrs.

# Mini-Scene®

**\$19.99**

Delightful HO scale Mini-Scenes add humor and realism to any layout. For miniature scene collectors and enthusiasts, these scenes stand alone and tell their story! Kits come complete with lead-free metal castings and landscape materials. Assemble and finish with Pewter Patina or Mini-Scene Paint Set. We recommend using super glue or a two-part epoxy to assemble Mini-Scenes. *All scenes designed to fit in Glass Display Dome and Base (3" diameter x 4 1/2" high).*



**Abandoned Log Cabin M101**



**Moonshine Still M102**



**The Windmill M103**



**The Hunter M104**



**The Sign Painter M105**



**The Tack Shed M106**



**Tommy's Treehouse M107**



**Outhouse Mischief M108**



**Ernie's Fruit Stand M109**



**Saturday Night Bath M110**



**Floyd's Barber Shop M111**



**Tractor Pit Stop M112**

## Mini-Scene Paint Set M125

**\$7.99**

Use for painting metal details. It includes 12 assorted colors: red, yellow, blue, black, gray, white, cream, tan, rust, yellow ocher, brown and dark brown. Paint is non-toxic, non-flammable and water-soluble.



## Pewter Patina Finish M126

**\$2.99**

For a quality pewter finish on Mini-Scenes, use our Pewter Patina Finish. Easily applied by brushing on and wiping off high spots. Finish is non-toxic, non-flammable and water-soluble.



## Glass Display Dome and Base M127

**\$11.99**

For the ultimate display and protection, use our 3" diameter x 4 1/4" high glass display dome. Plastic base is 1/2" high.



Scene Kits

This warning applies to all products on this page.



**WARNING:** Choking Hazard! Small parts. Not intended for children under 3 yrs.

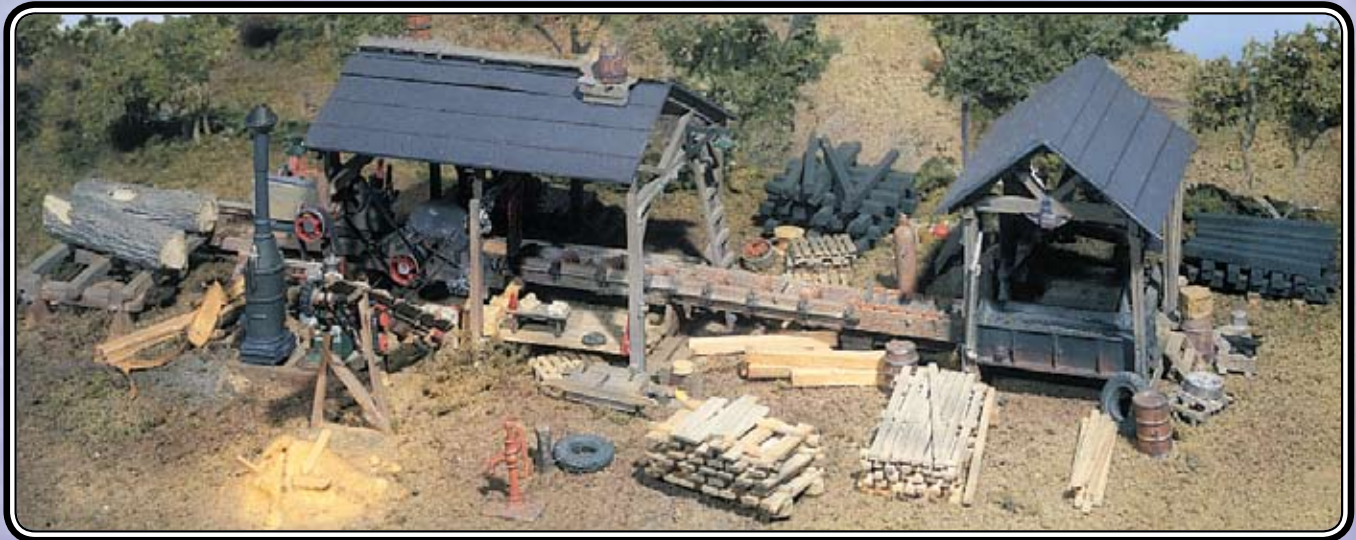

### Trackside Scenes™

Each HO scale Trackside Scene includes more than 70 highly detailed, lead-free metal castings. Kits contain all the details and landscape materials necessary to tell an authentic story in fine quality intricate detail, covering up to 200 square inches. Paint with Mini-Scene Paint Set (page 91). We recommend using super glue or a two-part epoxy to assemble Trackside Scenes.



**Possum Hollow** TS151 **\$39.99**

An abandoned caboose has been converted to a home for a backwoods family. The piles of accumulated junk add to the whimsy of the scene. *9" x 8" scene*



**Caboose & Sand Facility** TS152 **\$39.99**

This is a common sight found around railroad yards. The sand tower supplies the locomotives' needs while the storage shed keeps the caboose well-stocked. *9" x 8" scene*



**Otis Coal Company** TS153 **\$49.99**

Private coal companies were found along spur lines throughout the United States. Such facilities served as the link between the long coal trains and the consumer. *18" x 8" scene*



**Tie & Plank Mill** TS154 **\$49.99**

This small, steam-powered sawmill and dipping shed converted raw timber into ties and planks to supply the needs of local rail lines. *18" x 8" scene*

This warning applies to all products on this page.



**WARNING:** Choking Hazard! Small parts. Not intended for children under 3 yrs.

## Complete Scenes™

\$39.99

Create common scenes existing in railroad communities across America. Each HO scale kit contains all the highly detailed, lead-free metal castings, details and landscape materials necessary to assemble the scene in a variety of ways to best fit your layout space. Paint with Mini-Scene Paint Set (page 91). We recommend using super glue or a two-part epoxy to assemble Complete Scenes.



### Smiley's Tow Service S130

This scene includes over 60 white metal castings. Seven trees, Foliage and Turf are provided to make Smiley's a thriving enterprise.  
*7" x 9" scene*



### Maple Leaf Cemetery S131

It is mere chance if you find your name on one of the 28 tombstones included in this kit with more than 40 detailed accessories. Eight trees and all the Foliage and Turf are provided to make this scene.  
*8" x 11" scene*



### Memorial Park S132

A small community would not be complete without a place to get together on those warm summer evenings. Over 40 detailed accessories - trees, Foliage, Turf and the materials for fence and shed - are packed into this scene.  
*8" x 14" scene*

Scene Kits

This warning applies to all products on this page.



**WARNING:** Choking Hazard! Small parts. Not intended for children under 3 yrs.

## Grand Valley and Scenic Ridge Layout Kits

Enjoy creating a layout without using complicated calculations or expensive power tools! These kits are designed to work as stand-alone layouts or to customize as part of a larger layout. Both kits include all the necessary SubTerrain, terrain and landscape products, track plans and illustrated instructions.

*Layout Kits*

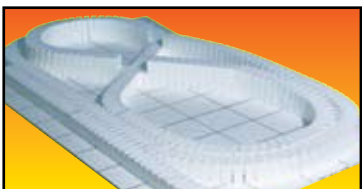

Install Risers and Inclines on track plan that is pre-printed on the base.

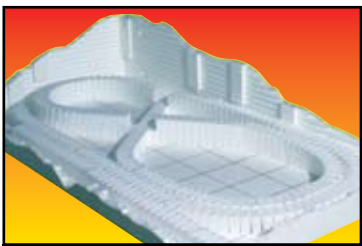

Cut profile contours with the Hot Wire Foam Cutter or Foam Knife.

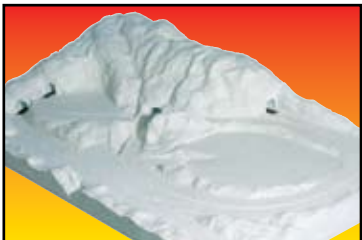

Use newspaper wads to form terrain contours and cover with wet Plaster Cloth to form a hard shell.



Install and color rocks and Tunnel Portals, paint terrain base and add roads using the Road System.



Landscap with ground covers and trees. Paint the layout profile, then add finishing details if desired.

# GRAND VALLEY

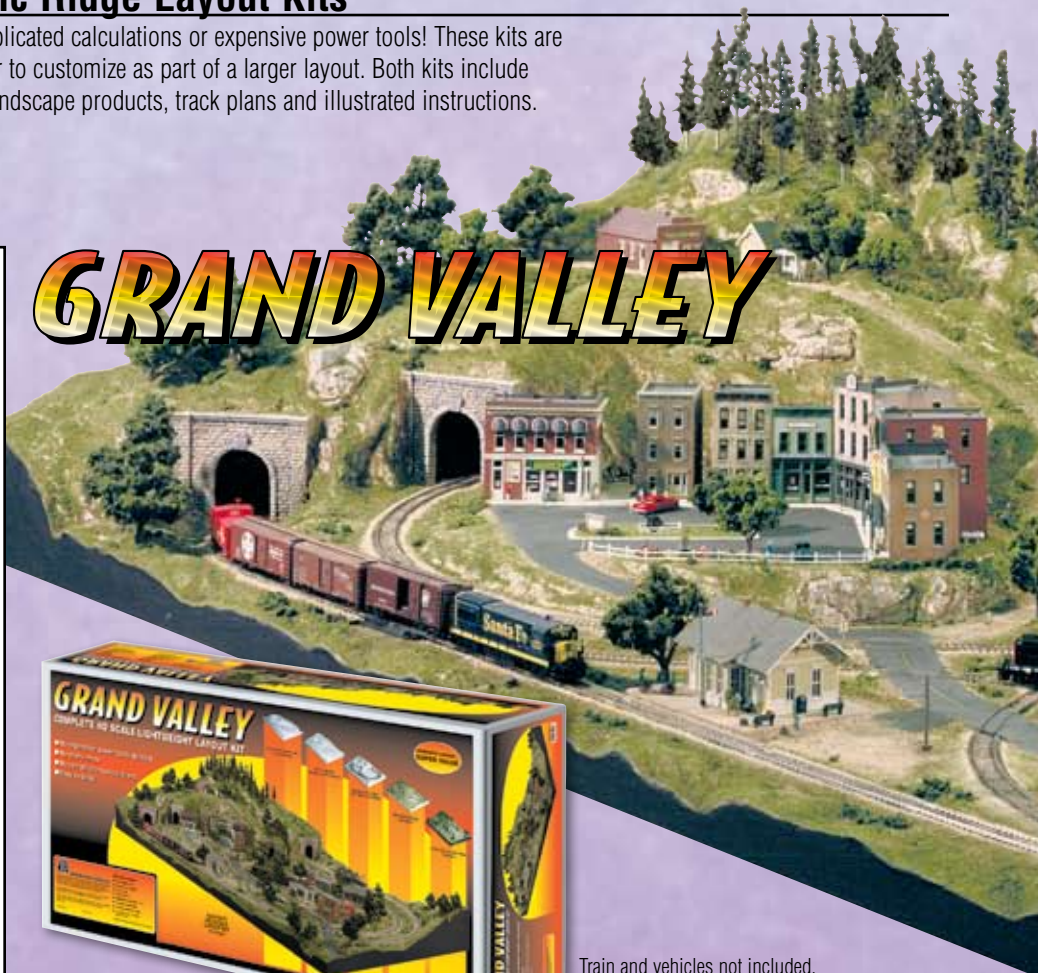

**Grand Valley**  
Layout Kit ST1483

Train and vehicles not included.  
Track and buildings sold separately.

**\$498.99**

# SCENIC RIDGE

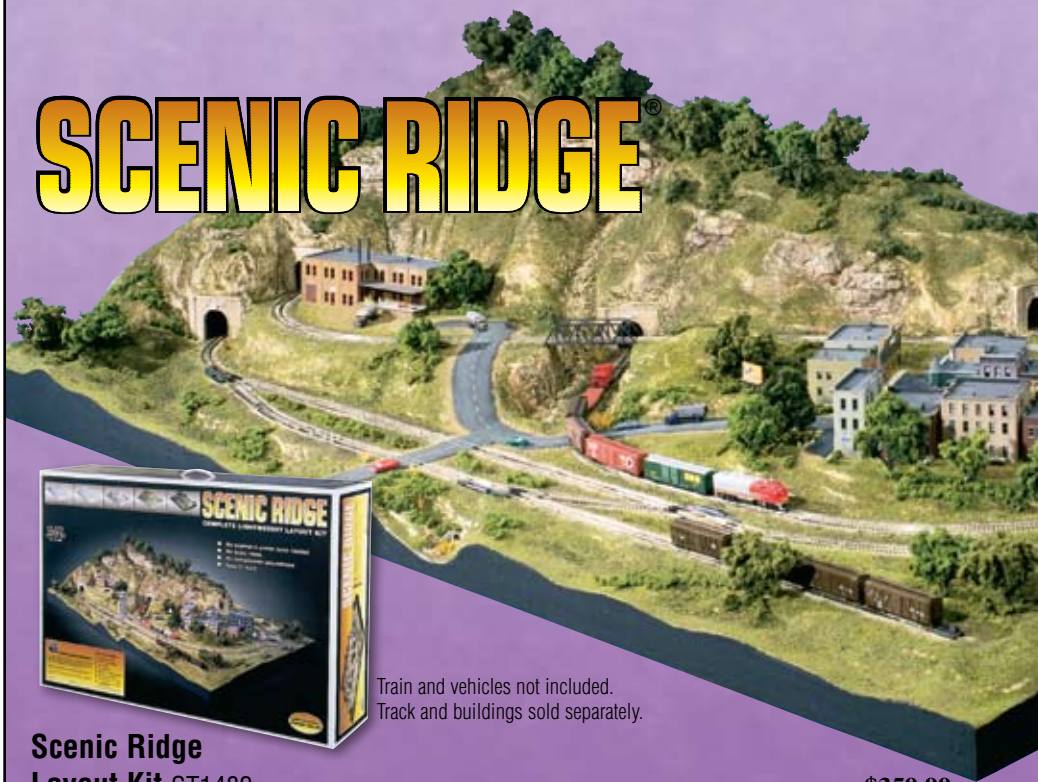

**Scenic Ridge**  
Layout Kit ST1482

Train and vehicles not included.  
Track and buildings sold separately.

**\$359.99**

This warning applies to all products on this page.



**WARNING:** Choking Hazard! Small parts. Not intended for children under 3 yrs.

Layout Kits



**City & Industry Building Set™** S1486 \$229.99

- Complements Grand Valley Layout Kit or any HO scale layout
- A complete city in a box
- 15 HO scale building kits
- Buildings feature molded-in, architectural details
- Over 160 detailed accessories and 130 Dry Transfer Decals
- Super value - saves money over items purchased separately

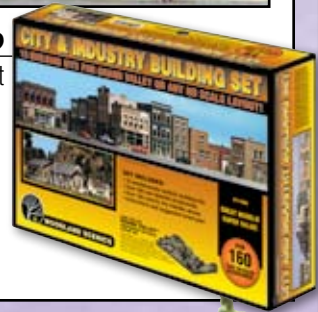

**HO SCALE**  
**4x8-foot**

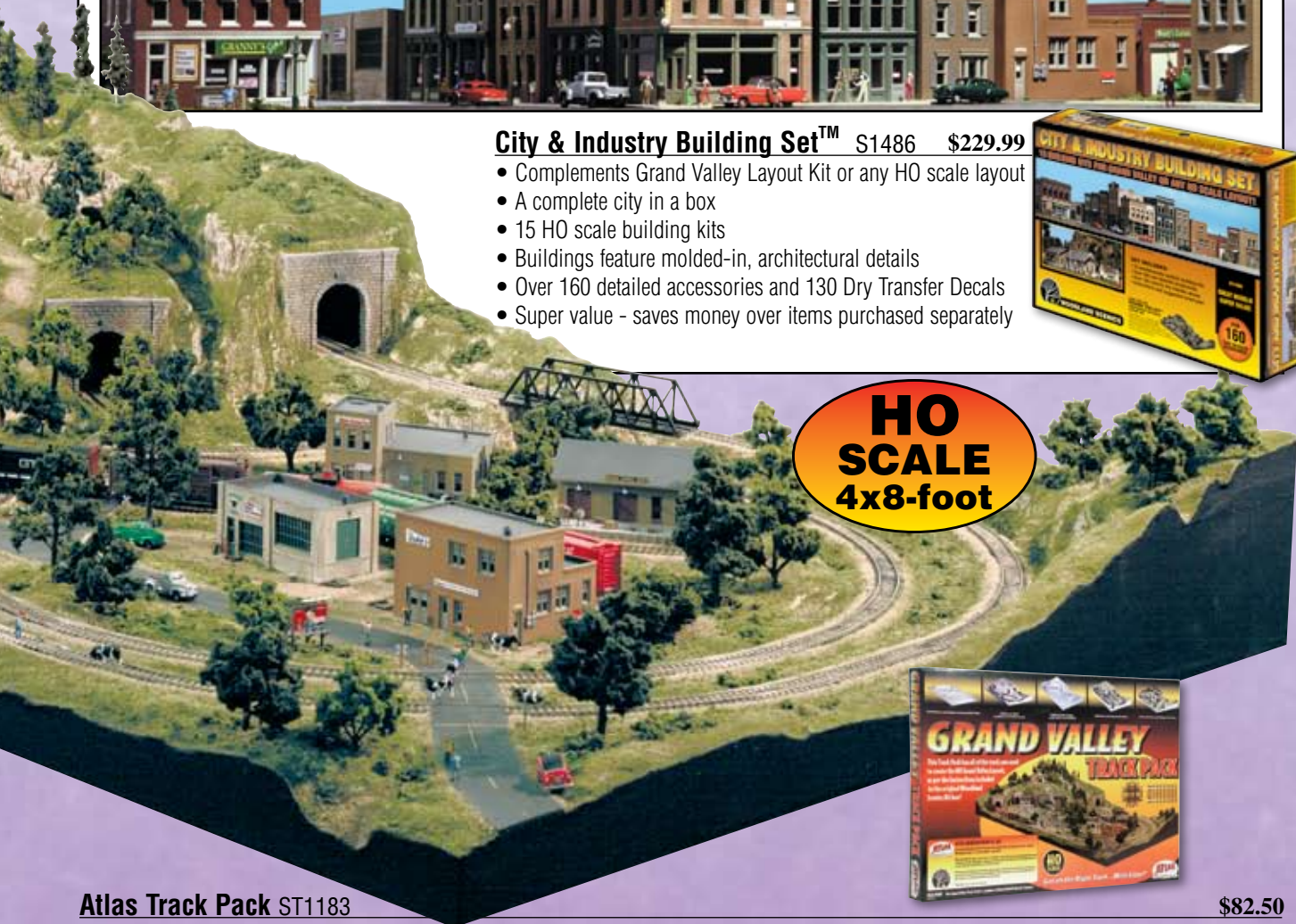

**Atlas Track Pack** ST1183

\$82.50

**N SCALE**  
**3x6-foot**

**Town and Factory Building Set™** S1485 \$134.99

- Complements Scenic Ridge Layout Kit or any N scale layout
- 13 N scale building kits
- Buildings feature molded-in, architectural detail
- Over 70 detailed accessories and 60 Dry Transfer Decals
- Super value - saves money over items purchased separately

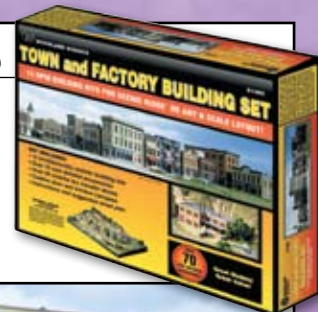

**Atlas Track Pack** ST1182

\$65.95

This warning applies to all products on this page.



**WARNING:** Choking Hazard! Small parts. Not intended for children under 3 yrs.

# RIVER PASS™

## Build a complete 4 x 8-foot layout with three easy-to-assemble kits

Designed to work together, these kits can also be used separately. Each kit includes detailed plans and instructions. Once River Pass is complete, the modeler will have completed a layout and developed the expertise to easily keep on building! River Pass can be used as a complete layout, expanded or attached to an existing layout.

Layout Kits

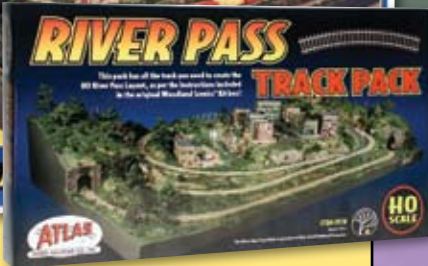
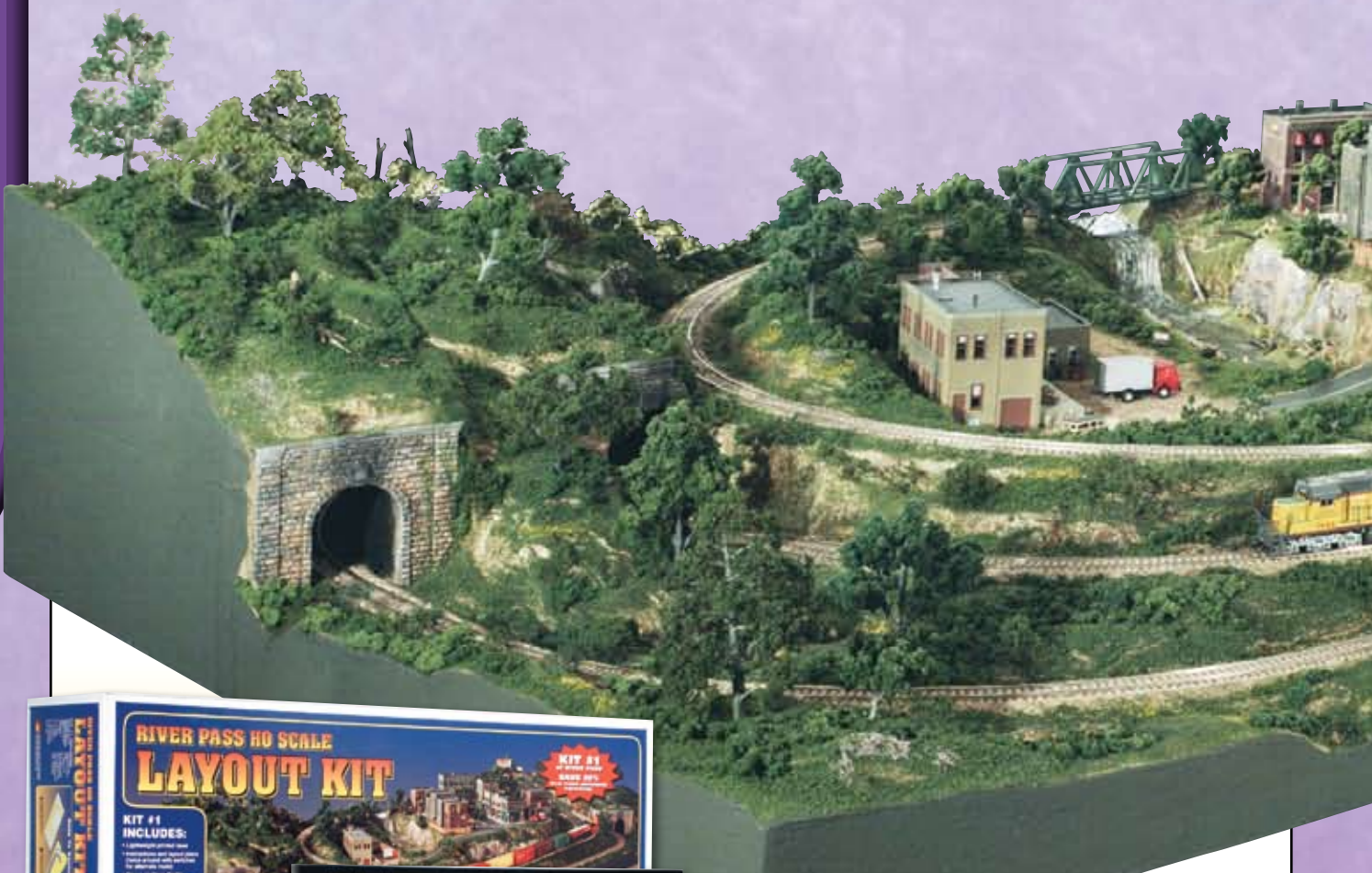

### River Pass Layout Kit ST1484 \$399.99

This kit includes all the materials needed to build a lightweight SubTerrain layout base. Build up the track and roads with Inclines and Risers and establish flat areas with Foam Sheets. Use Profile Boards to build perimeters. Then build up the terrain with newspaper wads and Plaster Cloth to make mountains, plains and other hard shell terrain features.

- No dusty mess
- No power tools or complicated calculations
- Designed for expansion

### Atlas Track Pack ST1184 \$71.50

### River Pass Scenery Kit S1488 \$249.99

This kit includes enough scenery materials to cover the River Pass Layout Kit or any 4 x 8-foot layout. It features Realistic Water and Water Effects, Dead Fall, Flowering Foliage, Underbrush, Bushes, Fine-Leaf Foliage, Rock Molds, Fine Turf, Ballast, Talus, Clump-Foliage, trees, Earth Colors Liquid Pigment, adhesives, Lightweight Hydrocal\* and Complete Road System.

- Over 40 products included
- Can be adapted to any scale
- Detailed instructions for River Pass placement

\*Hydrocal is a product of US Gypsum



This warning applies to all products on this page.  **WARNING:** Choking Hazard! Small parts. Not intended for children under 3 yrs.



**HO  
SCALE  
4x8-foot**

*Layout Kits*

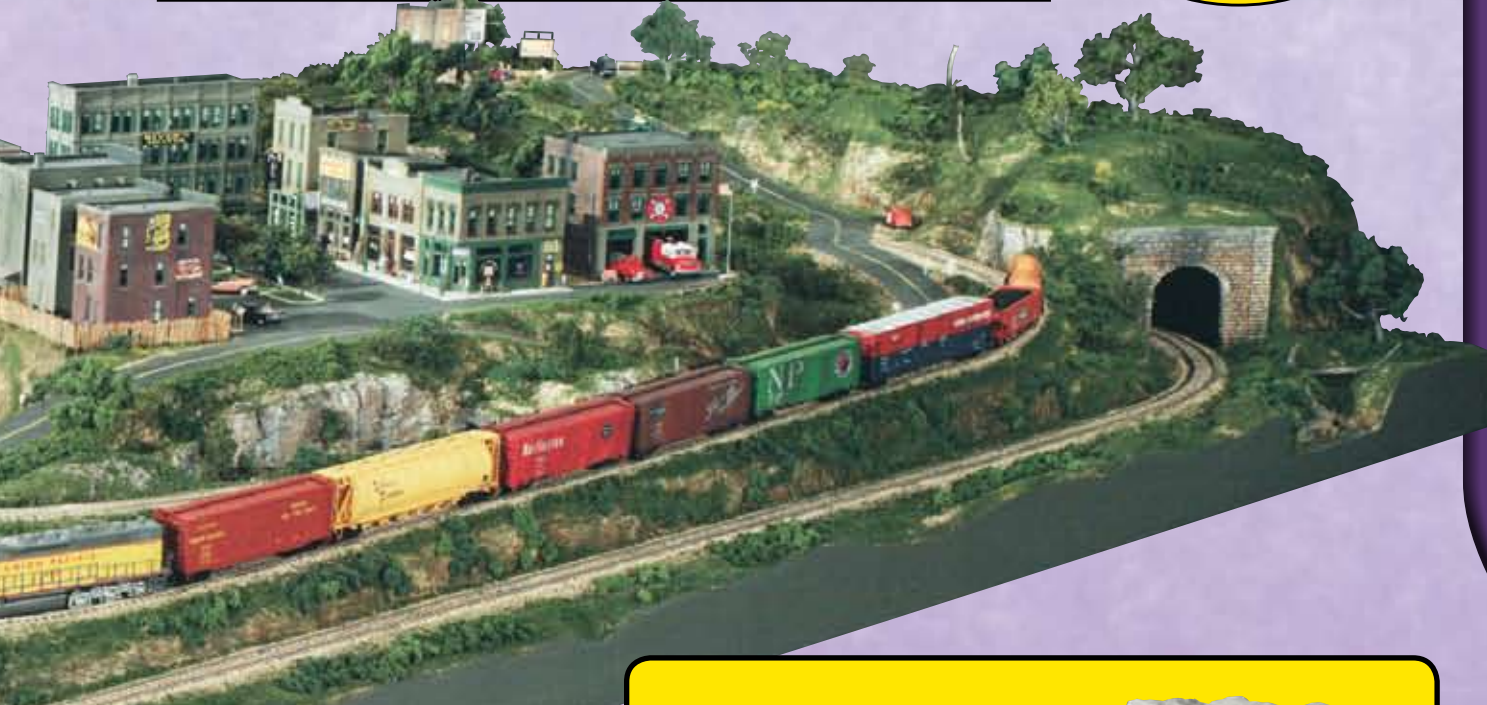

**River Pass  
Building Kits** S1487      \$229.99

This kit is a collection of 15 buildings, created with authenticity and fine detail. They include all the accessories and Dry Transfer Decals you'll need to detail the buildings on your layout. Use the included River Pass street plan, or create your own HO scale plan using an existing layout.

- Over 200 detailed accessories
- 110 Dry Transfer Decals
- 20 signs and posters



**Layout Base**



**Layout Base  
and Scenery**

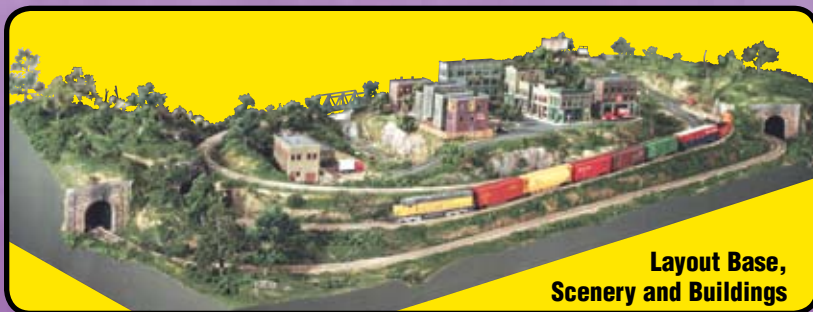

**Layout Base,  
Scenery and Buildings**

Train and vehicles not included in these kits. Track and buildings sold separately.



## Scenery Kits

### Mountain Valley® Scenery Kit S928

**\$89.99**

Bring your existing layout to life! Kit includes detailed, illustrated instructions and all the materials and patterns needed to add mountains, rocks, tunnel, ballast, landscape and trees.

- Covers a 4 x 8-foot area
- Designed for HO scale, adapts to N or O
- Over 24 products included
- Teaches terrain and landscape techniques

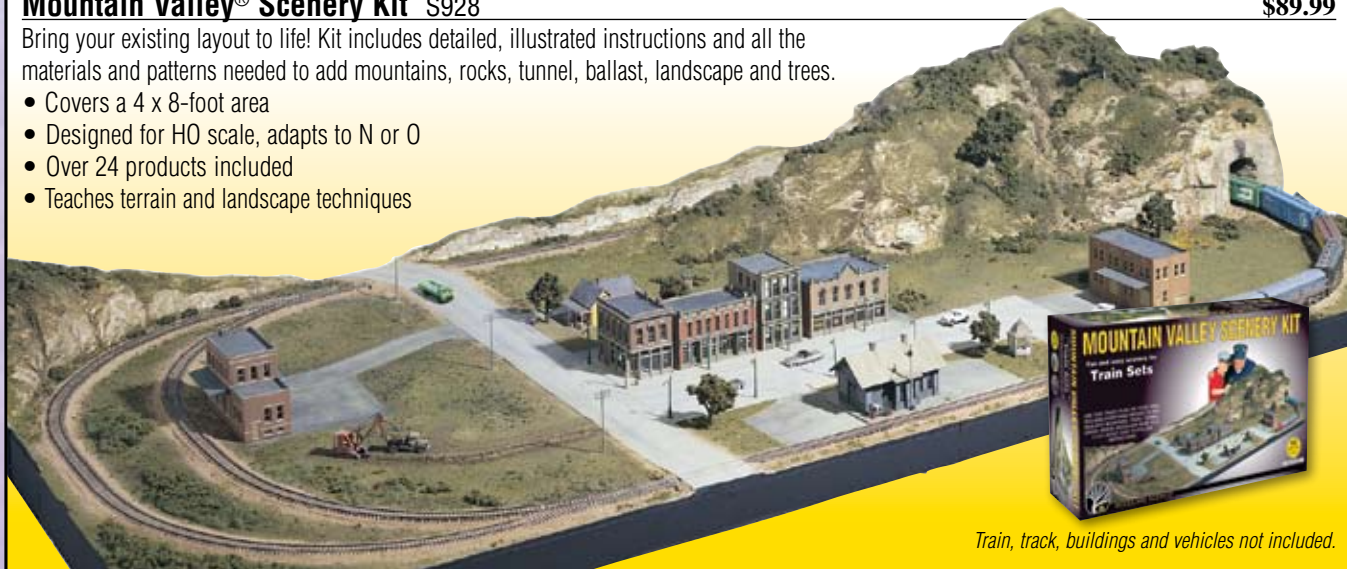

*Train, track, buildings and vehicles not included.*

### Complete Landscape Kit S926 \$39.99

Excellent landscape starter kit that includes an assortment of our products.

- 18 lead-free metal tree armatures
- 3 colors of Foliage
- 7 tree Stumps
- 2 packages of Green Blend Blended Turf
- 3 packages of Turf accent colors



### The Scenery Kit S927 \$64.99

This kit is for beginners.

- Learn terrain and landscape techniques
- Build a 10 x 18-inch HO scale diorama
- Over 20 products included
- Display an engine or piece of rolling stock

*Train not included.*



### SubTerrain Scenery Kit S929 \$64.99

This kit uses SubTerrain, Terrain and Landscape Systems.

- Build a 12 x 24-inch N scale diorama
- Learn SubTerrain's five easy steps - no mess or complicated calculations
- Create realistic terrain features with Plaster Cloth, rock castings and a Tunnel Portal
- Make trees and landscape with various ground covers, Ballast, Talus and other scenery products

*Train not included.*



This warning applies to all products on this page.



**WARNING: Choking Hazard! Small parts. Not intended for children under 3 yrs.**

### River Pass Scenery Kit S1488

**\$249.99**

This kit includes a variety of landscape products, such as Realistic Water, Water Effects, Fine-Leaf Foliage, Dead Fall and more! Designed for River Pass layout kit, but will cover any 4 x 8-foot layout.

- More than 40 products included
- Adapt to any scale



*Track sold separately.*

### Collectible House Display Kit CH1057

**\$34.99**

Learn to easily build a scenic display for your collectible house. This kit includes all the materials necessary to build this enchanting diorama. Display on a desk, dresser or any tabletop. Great for beginner to expert modelers.

- Makes an 18 x 10-inch display
- More than 11 products included
- Learn to use the Terrain and Landscape Systems

*House not included.*



### Build a Display for Collectible Houses

**VHS CH1056 - DVD CH1055**

**\$19.99**

This step-by-step video teaches you to build a 31 x 44-inch display for your collectible houses. Display enchanting scenery dioramas year-round and easily modify to fit any table, buffet, TV, dresser, fireplace or mantel. Video includes step-by-step instructions, tips, techniques and ideas for each product used.

*Houses, people and streetlights not included.*



*Layout Kits*

# Dry Transfer Decals

Give your layout, diorama or miniature scene that special touch of authenticity. Dry Transfer Decals represent a wide variety of shapes, sizes and colors and are the quick and easy way to make your hobby projects look great! Depending on the specific application, decals are suitable for O, HO and N scale. The wide range of full color designs adds detail and realism to buildings, fences, signs and boxcars. So easy, you'll never use wet process decals again! 4" x 5" sheets



1. Position the Dry Transfer Decal where you want it and rub over the top with a burnisher or dull pencil.
2. Carefully remove the carrier sheet.
3. Place the backing paper over the Dry Transfer Decal and burnish again. Smooth into rough or textured surfaces with light pressure from your thumb or an eraser.
4. Dry Transfer Decals can be "weathered" with a light sanding or other various techniques.

## Dry Transfer Burnisher DT600 \$5.99

Use a Burnisher to transfer decals from the carrier sheet to any surface. Made of a smooth-gliding plastic, the Burnisher has two points: a fine point for small Dry Transfers and a wide blade with a chisel for burnishing larger areas and working Dry Transfer Decals into textures.

**Signs & Posters**  
Transform your cities and towns with color, variety and life. Easily create a large array of business, advertising and railroad signs using D245, DT551-DT557 and DT559-DT563.

**Series One**  
D245 \$6.49

**Tavern, Gas Station & Commercial Signs**  
DT551 \$6.49

**Assorted Logos & Advertising Signs**  
DT552 \$6.49

**Depot, R.E.A. & Advertising Signs**  
DT553 \$6.49

**Product & Advertising Signs**  
DT554 \$6.49

**Road Product & Burma-Shave Signs**  
DT555 \$6.49

**Assorted Logos & Advertising Signs**  
DT556 \$6.49

**Data Warning Labels & Commercial Signs**  
DT557 \$6.49

**Assorted Products & Business Signs**  
DT559 \$6.49

**Crate Labels & Warning Signs**  
DT560 \$6.49

**1960's Signs & Posters**  
DT561 \$6.49



**1950's Signs & Posters**  
DT562 \$6.49



**1940's Signs & Posters**  
DT563 \$6.49

**Letters, Lines and Numbers**  
Add graphic touches and create your own custom signs with Dry Transfer letters, lines and numbers. DT501-DT516

Application is as simple as positioning the Dry Transfer in the desired area, rubbing gently on the back and slowly peeling away the carrier sheet.

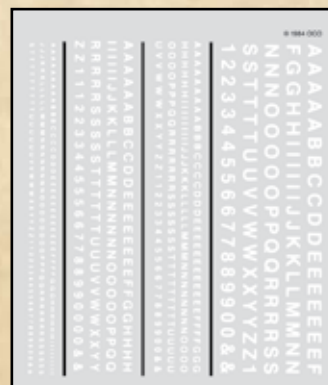

**R.R. Gothic-White**  
(1/16", 3/32", 1/8", 3/16")  
DT507 (Black-DT508) \$4.79

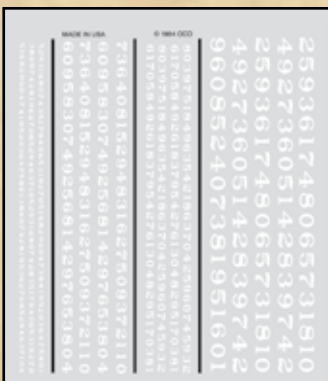

**R.R. Roman Numbers-White**  
(1/16", 3/32", 1/8", 3/16")  
DT510 (Black-DT509) \$4.79

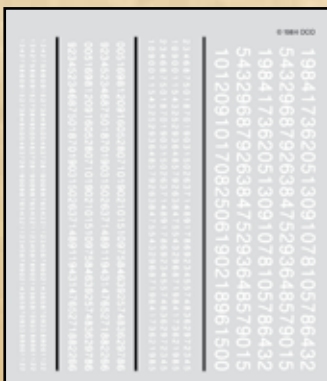

**R.R. Gothic Numbers-White**  
(1/16", 3/32", 1/8", 3/16")  
DT512 (Black-DT511) \$4.79

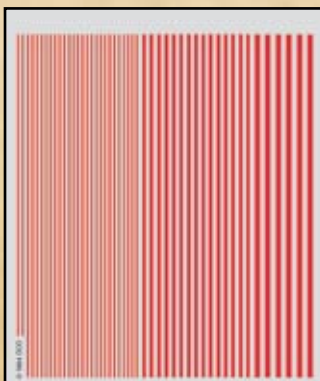

**Stripes-Red\*** (1/64", 1/32", 1/16")  
DT515  
(Black-DT513, White-DT514, Yellow-DT516) \$4.79

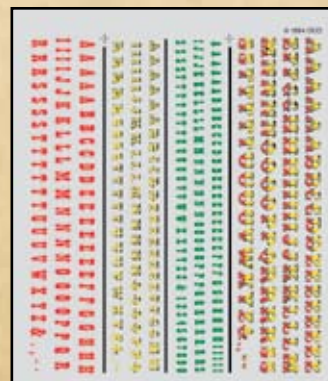

**Tuscan & Playbill**  
1/16", 3/32", 1/8", 3/16"  
DT501 \$4.79



**Benton & Windsor**  
3/32", 1/8", 3/16", 1/4"  
DT502 \$4.79



**Gothic Outline & Sign Painter**  
5/16", 3/16"  
DT503 \$4.79



**R.R. Roman Red/Gold**  
1/16", 3/32", 1/8", 3/16"  
DT504 \$4.79



**R.R. Roman White**  
1/16", 3/32", 1/8", 3/16"  
DT506 (Black-DT505) \$4.79

**Box Car**  
Expertly detail your box cars with the logos, heralds and reporting marks of individual railroads. DT558, DT601-DT611

For maximum realism, Dry Transfer Decals are reproduced in full color.

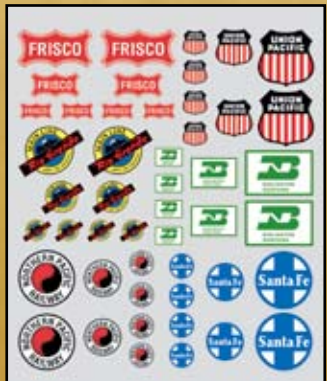

**Railroad Herald's\***  
DT558 \$6.49

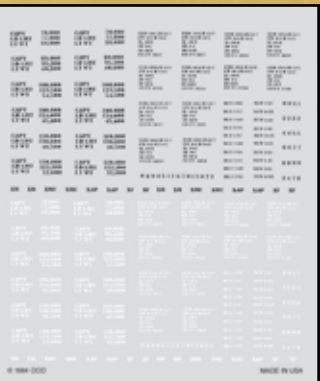

**Box Car Data-Roman Black/White HO Scale**  
DT601 \$4.79

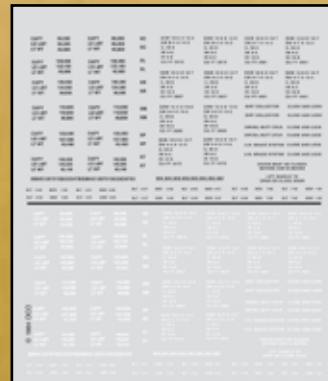

**Box Car Data-Gothic Black/White HO Scale**  
DT602 \$4.79

\*Products bearing Union Pacific, Southern Pacific and Rio Grande marks are made under trademark license from Union Pacific Railroad Company.

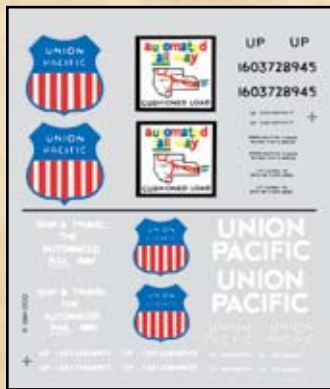

**Union Pacific Box Cars\***  
DT603 \$4.79



**Santa Fe Box Cars El Capitan/Super Chief**  
DT604 \$4.79



**Santa Fe Box Cars Shock Control/Ship & Travel**  
DT605 \$4.79



**Rock Island Box Cars Soft Touch/DF HO Scale**  
DT606 \$4.79



**BN and CB & Q Box Cars General Freight/Everywhere West**  
DT607 \$4.79



**Frisco Box Cars Ship IT on the Frisco/Frisco Fast Freight**  
DT608 \$4.79



**Southern Pacific Box Cars\***  
DT609 \$4.79



**Great Northern Box Cars**  
DT610 \$4.79

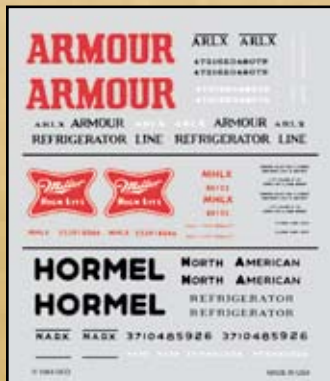

**Reefer Cars Armour/Miller/Hormel HO Scale**  
DT611 \$4.79

**Mini-Series**  
The same quality and variety of Dry Transfer Decals as our originals, only in a small size. Perfect for N scale modelers and anywhere smaller signs and logos are required.  
DT570-DT575



**Mini-Series Product Logos**  
DT570 \$6.49



**Mini-Series Railroad Signs\***  
DT571 \$6.49



**Mini-Series Business Signs**  
DT572 \$6.49



**Mini-Series Signs & Posters**  
DT573 \$6.49



**Mini-Series Service Station Signs**  
DT574 \$6.49



**Mini-Series Lettering Black & White**  
DT575 \$4.79

\*Products bearing Union Pacific, Southern Pacific and Rio Grande marks are made under trademark license from Union Pacific Railroad Company.



**Model Graphics®**

\$5.79

Intricate detailing is quick, easy and realistic with Model Graphics Dry Transfer Decals. Place where desired and burnish (see instructions on page 100). Model Graphics 64-sheet selection of Dry Transfer Decals contain 340 different alphabets, number sets and line assortments to satisfy the lettering and striping needs of every craftsman. Depending on the specific application, Model Graphics are suitable for O, HO and N scales. 5 5/8" x 8 1/4" sheets

Measurements shown in inches.

**Dry Transfer Burnisher DT600**

\$5.99

Use this Burnisher to transfer Model Graphics from their carrier sheet to any surface.



M V H Q I S  
1/16 3/32 1/8 3/16 1/4 5/16

**Roman, R.R.**  
MG701 (Black) MG702 (White)  
MG703 (Gold) MG704 (Red)  
MG705 (Yellow) MG706 (Silver)

3 6 9 2 4 8  
1/16 3/32 1/8 3/16 1/4 5/16

**Numbers Roman, R.R.**  
MG707 (Black) MG708 (White)  
MG709 (Gold) MG710 (Red)  
MG711 (Yellow) MG712 (Silver)

N 8 G I  
3/8 1/2

**Roman, R.R.**  
MG713 (Black)  
MG714 (White)

E A I Z Q  
1/16 3/32 1/8 3/16 1/4

**Extended Roman, R.R.**  
MG715 (Black)  
MG716 (White)  
MG717 (Gold)

B V N S X R  
1/16 3/32 1/8 3/16 1/4 5/16

**Condensed Roman, R.R.**  
MG718 (Black)  
MG719 (White)

A D O B X J  
1/16 3/32 1/8 3/16 1/4 5/16

**Gothic, R.R.**  
MG720 (Black) MG721 (White)  
MG722 (Gold) MG723 (Red)  
MG724 (Yellow) MG725 (Silver)

1 3 5 7 9 0  
1/16 3/32 1/8 3/16 1/4 5/16

**Numbers Gothic, R.R.**  
MG726 (Black) MG727 (White)  
MG728 (Gold) MG729 (Red)  
MG730 (Yellow) MG731 (Silver)

F 2 L 3  
3/8 1/2

**Gothic, R.R.**  
MG732 (Black)  
MG733 (White)

P U K W E  
1/16 3/32 1/8 3/16 1/4

**Extended Gothic, R.R.**  
MG734 (Black)  
MG735 (White)  
MG736 (Gold)

J M S I K E  
1/16 3/32 1/8 3/16 1/4 5/16

**Condensed Gothic, R.R.**  
MG737 (Black)  
MG738 (White)

B G U S O A  
1/16 3/32 1/8 3/16 1/4 5/16

**45° USA Gothic**  
MG739 (Black) MG740 (White)  
MG741 (Red) MG742 (Yellow)  
MG743 (Silver)

G 3 S 9  
3/8 1/2

**45° USA Gothic**  
MG744 (Black)  
MG745 (White)

0 9 7 5 2 8  
1/16 3/32 1/8 3/16 1/4 5/16

**Numbers 45° USA Gothic**  
MG746 (Black) MG747 (White)  
MG748 (Red) MG749 (Yellow)  
MG750 (Silver)

P K T S N G  
3/32 1/8 1/4 3/32 1/8 1/4

**Stencil & Block Roman**  
MG751 (Black) MG752 (White)  
MG753 (Red) MG754 (Yellow)

X 9 P 7 O 8 K 1  
3/16 5/16 3/16 5/16

**Script & Old English**  
MG755 (Black) MG756 (White)  
MG757 (Gold) MG758 (Silver)

Stripes  
.010 1/64 .022 1/32 3/64

MG759 (Black) MG760 (White)  
MG761 (Gold) MG762 (Red)  
MG763 (Yellow) MG764 (Silver)

See page 144 for merchandiser.

This warning applies to all products on this page. **WARNING: Choking Hazard! Small parts. Not intended for children under 3 yrs.**

### Hob-Bits®

These are high-quality brass machine screws, nuts and washers. The machine screws come in four sizes and four different styles. They are the ideal precision fasteners for countless hobby projects. Hob-Bits tools include wrenches, taps and dies for all four sizes shown below.



Round Head Screws			
No.	Size	Length	Qty.
H801	00-90	1/8"	5
H802	00-90	1/4"	5
H803	00-90	3/8"	5
H804	00-90	1/2"	5
H805	0-80	1/8"	5
H806	0-80	1/4"	5
H807	0-80	3/8"	5
H808	0-80	1/2"	5
H809	1-72	1/8"	5
H810	1-72	1/4"	5
H811	1-72	3/8"	5
H812	1-72	1/2"	5
H813	2-56	1/8"	5
H814	2-56	1/4"	5
H815	2-56	3/8"	5
H816	2-56	1/2"	5

Fillister Head Screws			
No.	Size	Length	Qty.
H821	00-90	1/8"	5
H822	00-90	1/4"	5
H823	00-90	3/8"	5
H824	00-90	1/2"	5
H825	0-80	1/8"	5
H826	0-80	1/4"	5
H827	0-80	3/8"	5
H828	0-80	1/2"	5
H829	1-72	1/8"	5
H830	1-72	1/4"	5
H831	1-72	3/8"	5
H832	1-72	1/2"	5
H833	2-56	1/8"	5
H834	2-56	1/4"	5
H835	2-56	3/8"	5
H836	2-56	1/2"	5

Flat Head Screws			
No.	Size	Length	Qty.
H841	00-90	1/8"	5
H842	00-90	1/4"	5
H843	00-90	3/8"	5
H844	00-90	1/2"	5
H845	0-80	1/8"	5
H846	0-80	1/4"	5
H847	0-80	3/8"	5
H848	0-80	1/2"	5
H849	1-72	1/8"	5
H850	1-72	1/4"	5
H851	1-72	3/8"	5
H852	1-72	1/2"	5
H853	2-56	1/8"	5
H854	2-56	1/4"	5
H855	2-56	3/8"	5
H856	2-56	1/2"	5

Hex Head Screws			
No.	Size	Length	Qty.
H861	00-90	1/8"	5
H862	00-90	1/4"	5
H863	00-90	3/8"	5
H864	00-90	1/2"	5
H865	0-80	1/8"	5
H866	0-80	1/4"	5
H867	0-80	3/8"	5
H868	0-80	1/2"	5
H869	1-72	1/8"	5
H870	1-72	1/4"	5
H871	1-72	3/8"	5
H872	1-72	1/2"	5
H873	2-56	1/8"	5
H874	2-56	1/4"	5
H875	2-56	3/8"	5
H876	2-56	1/2"	5

Dies		
No.	Size	Qty.
H877	00-90	1
H878	0-80	1
H879	1-72	1
H880	2-56	1

Hex Nuts		
No.	Size	Qty.
H881	00-90	5
H882	0-80	5
H883	1-72	5
H884	2-56	5

Wrenches		
No.	Size	Qty.
H885	00-90	1
H886	0-80	1
H887	1-72	1
H888	2-56	1

Washers		
No.	Size	Qty.
H891	00-90	5
H892	0-80	5
H893	1-72	5
H894	2-56	5

Taps		
No.	Size	Qty.
H895	00-90	1
H896	0-80	1
H897	1-72	1
H898	2-56	1

### Hob-E-Lube® Premium Oils

These oils are plastic and paint compatible. They come with a metal cap and 2 1/4" needle applicator (for hard to reach areas). .5 fl. oz./15 ml.

#### Ultra-Lite Oil HL661 \$7.99

Contains proven anti-wear additives. Use on HO and smaller scales of model trains, precision instruments or where a light oil is needed.

#### Lite Oil HL662 \$7.99

Multi-viscosity additives for trouble-free operation, even at extreme temperatures. Great for home and workshop applications.

#### Medium Oil HL663 \$7.99

Prevents metal contact and surface scuffing. Specially formulated for use on R/C cars, airplanes, boats and HO scale and larger model trains.

#### Gear Lube HL664 \$7.99

A true gear lubricant, where tough, lasting gear oil is needed.

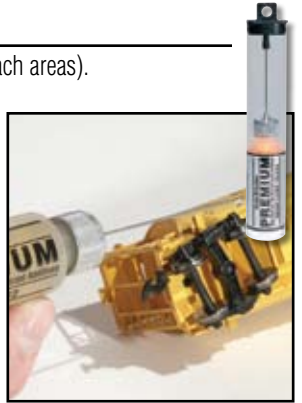

### Hob-E-Lube® Lubricants

Use these lubricants on model trains, R/C cars, planes and boats.

#### Dry Graphite HL651 \$4.99

With Molybdenum: will not collect dust, has good adherence properties and clings to sliding surfaces. Ideal for metal, wood, plastic and rubber. .23 oz.

#### Dry White Lube HL652 \$4.99

With Teflon\*: is white and non-staining. It will not conduct electricity or collect dust. Use on metal, wood, plastic and rubber. .125 oz.

#### Ultra-Lite Oil HL653 \$4.99

A light viscosity oil for small, precision parts. Penetrates and lubricates close-tolerance areas. Includes extension tip for hard-to-reach areas. .5 fl. oz.

#### Lite Oil HL654 \$4.99

A multi-viscosity, general-purpose hobby lubricant for light load-bearing applications. An ideal rust preventative. Includes extension tip for hard-to-reach areas. .5 fl. oz.

#### Gear Lube HL655 \$4.99

A tough, long-lasting, heavy-duty, hobby lubricant with tack additive for anti-drip adherence. Use on small gears and at high friction points. Includes extension tip for hard-to-reach areas. .5 fl. oz.

#### Moly Grease HL656 \$4.99

With Molybdenum: covers the entire surface and maintains viscosity at high temperatures. A high load-bearing, waterproof grease that stays put. .34 oz.

#### White Grease HL657 \$4.99

With Teflon\*: a non-staining, clean lubricant that is waterproof and protects against corrosion. .34 oz.



#### 7-Pak Workbench Assortment HL650 \$26.99

This super-saver value includes all seven lubricants, plus instructions that list applications and the exact lubricant to use.



\*DuPont registered trademark.



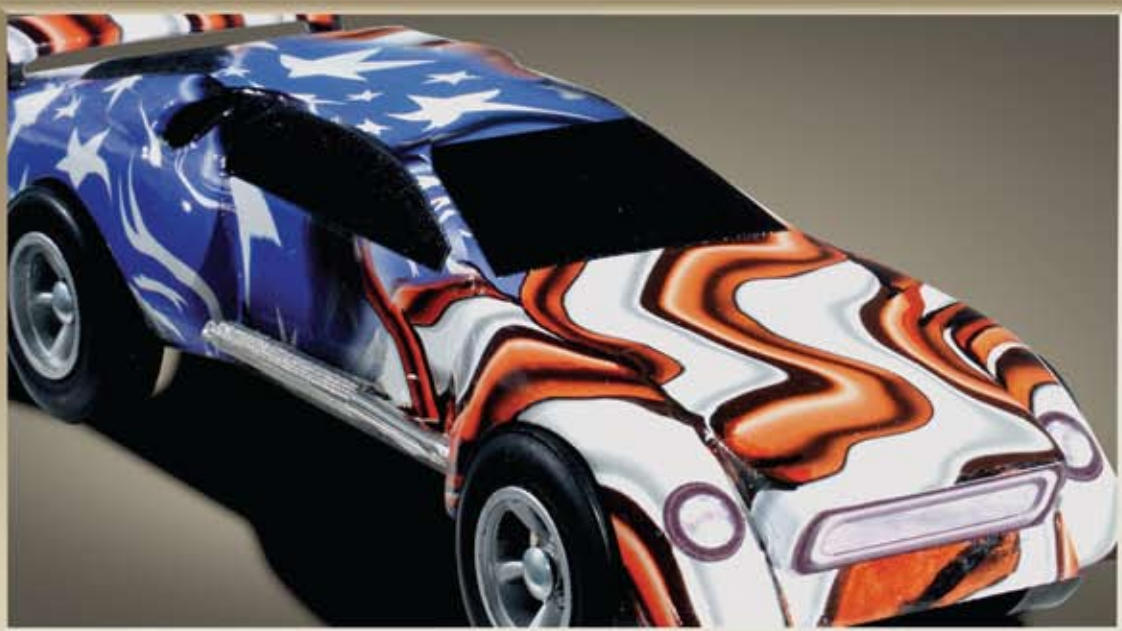

*If you want to finish first...*

**PINECAR®**

2010

PineCar Racers are small models built to specific dimensions and raced by gravity down an inclined track. PineCar is a leading supplier of these small racers and all the accessories. Our selection of racer bodies and kits, with pre-cut axle grooves, give racers a fair chance to compete. With PineCar's variety of custom parts, canopies and decals, your racer will be the sharpest on the track.

## How-To Book P383

\$4.29

This book is a guide to help you learn the principles of design for both speed and looks. It includes tips on cutting out PineCar Racers, painting instructions to achieve a great-looking finish and techniques to help you create the fastest racer on the track.



## Program Guide P450

\$3.00

A fully-illustrated booklet with easy-to-follow, step-by-step instructions on conducting a PineCar or SailBoat race. Booklet includes planning the event, setting up the race floor plan, selecting the racer kits and organizing the race.

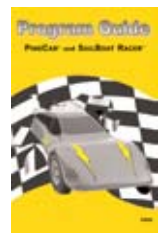

## Building PineCar Racers

VHS P3940 - DVD P3941

\$14.99

This comprehensive video/DVD can teach anyone how to build a winning racer. It includes step-by-step instructions beginning with a wood block and advancing through the designing, cutting, shaping and finishing stages. Approximately 45 minutes.



## PineCar Racer® Bodies and Kits

It all starts with the basic wood block or wedge. Both have been cut from the best fine-grain, soft wood. Each piece is knot-free, so carving a racer design is easy. These kits require some woodworking tools. You will be able to create a unique racer of your own design. Choose the kit you want and add accessories and speed equipment to make a winning racer. All wedges and blocks have pre-cut axle grooves.

### PineCar Racer Basic Kit P370 ⚠️ \$3.99

Includes a wood block, wheels, hubcaps, four nail-type axles and two one-piece axles\*.

*\*Official BSA wheels and axles fit all PineCar Racers*

*Racer shown was made with PineCar Racer Basic Kit (P370) and Dry Transfer Decals Dragonfire (P308).*



### PineCar Racer Wedge Kit P369 ⚠️ \$3.99

Ready to go. No tools required: just sand, paint and decorate. Includes a wedge, wheels and four nail-type axles\*.

*\*Official BSA wheels and axles fit all PineCar Racers*

*Racer shown was made with Designer Kit With Wedge Black Widow (P420).*



### Block P361

HOW-TO VIDEOS  
pinecar.com

\$2.99

Use it to make your own unique racer body, or as a replacement block if you make a mistake! Also great for cutting out fenders or other add-on parts.



### Wedge P360

\$2.99

Use it to make your own unique racer body, or as a replacement wedge if you make a mistake! Also great for cutting out fenders or other add-on parts.



**⚠️ CHOKING HAZARD** (see page 2) Not intended for children under 3 yrs.

See page 146 for merchandiser.

PineCar®

### Pre-Cut Designs

\$6.99

Rough-cut, unfinished shapes for those who want a great-looking racer, but may not have the necessary woodworking tools or skills. The designs come in eight basic shapes: each can be finished by simply sanding and painting. *Details, custom parts, axles and wheels not included.*



**Funnycar** P362



**Grand Prix** P363



**Roadster** P364



**Deuce Coupe** P365



**Ferrari** P366



**Dragster** P367



**GT Racer** P3965



**Truckster 4x4** P3966

### Aerodynamic Pre-Cut Designs

\$9.99

PineCar's new Pre-Cut Designs are low profile and aerodynamic blocks, rough-cut and ready-to-finish. Each Pre-Cut has prepared cavities for round or flat weights and extra grooves for an optional extended wheelbase. This is the perfect design for those who want a great looking, great racing car but may not have the necessary wood working tools or skills.

**NEW**



**Hammerhead** P3967



**Stealth** P3968



**White Lightning** P3969



**The Blur** P3970

### Speed Racer Kit P3935

\$11.99

For a winning edge, get the Speed Racer Kit. This gravity-driven racer sports a new innovative weight system. Its simple design was created using principles of physics, with consideration for racing properties, such as aerodynamics, weight distribution and airflow factors. Kit includes one-piece axles, wheels, racer body, hubcaps, a lead-free cavity weight and top weight with screws. *Sandpaper, lubricant and paint not included*



### Deluxe Car Kits

\$12.99

Each kit contains a different pre-cut, unfinished racer body, Dry Transfer Decals, a lead-free incremental weight with screws, wheels, one-piece axles, hubcaps and custom parts, such as headers, engines and pipes. *Lubricant, glue and paint not included*



**Turbo Funnycar** P371



**Formula Grand Prix** P372



**Wildfire Roadster** P373



**Bandit Coupe** P374



**GTS Ferrari** P375



**Slingshot Dragster** P376

 **CHOKING HAZARD** (see page 2) Not intended for children under 3 yrs.

This warning applies to all products on this page.



**WARNING:** Choking Hazard! Small parts. Not intended for children under 3 yrs.

### PineCar Racer Premium Kits

\$14.99

Complete racer kits that are great for any skill level and require few tools. Kits come in six cool racing designs and contain everything needed to build and accessorize winning racers. Includes pre-cut body, body details, detail parts, wheels, two one-piece axles, hubcaps, a lead-free incremental weight with screws, sandpaper, body paint, gloss finish, two accent paints, two paintbrushes and decals. *Glue not included*



**Furious Racer** P3945



**Baja Racer** P3946



**Can Am Racer** P3947



**Muscle Racer** P3948



**West Coast Growler** P3949



**Blue Venom** P3950



1. Sand racer body.



2. Glue on body details.



3. Paint.



4. Add decals and detail parts.



5. Paint with gloss finish.



6. Attach wheels and weights.

### Designer Kits

\$6.49

Each kit includes a different template to create a three-dimensional shape, plus pre-fabricated fenders and Dry Transfer Decals to decorate your racer. All kits include a lead-free incremental weight with screws and black accent material to add realistic windows. *Block, wheels and axles not included*



**Screamin' Eagle** P413



**Starfire** P414



**Batcar** P415



**Thunderbolt** P416

### Designer Kits With Wedge \$10.99

Use the template provided to add pre-fabricated canopies, spoilers and other three-dimensional designer body details to the pre-cut wedge. Dry Transfer Decals, black accent material, racing wheels, hubcaps, one-piece axles and lead-free incremental weights with screws add finishing touches. *Sandpaper, paint and glue not included*



**Black Widow** P420



**The Avenger** P421

PineCar®

## Body Skin® Custom Transfers \$6.49

Turn a plain racer into an awesome racing machine! Instead of paint, wrap your winning racer with Body Skin Custom Transfer designs for a customized racer finish. Use skins as a complete wrap or to create accents and details. Product application is fast, easy and requires no artistic talent: simply apply with a wet sponge. Black window material also included. Sheet size: 5 5/8" x 9 1/8".

**HOW-TO  
VIDEOS**  
pinecar.com



Racer shown was made with Body Skin Custom Transfer Fire Starter (P3977) and spoiler from PineCar Racer Premium Kit Baja Racer (P3946).



**Lightning Strikes**  
P3975

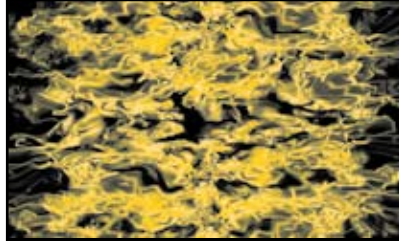

**Smoke Screen**  
P3976

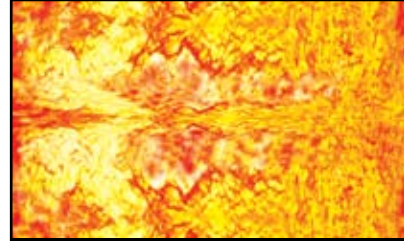

**Fire Starter**  
P3977



**Camouflage**  
P3978

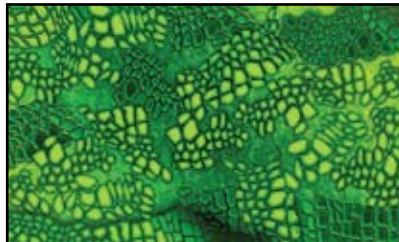

**Gator**  
P3979



**Freedom Flag**  
P3980

**NEW**

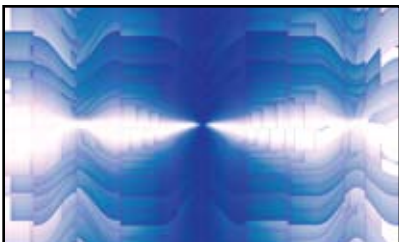

**Illusion**  
P3981

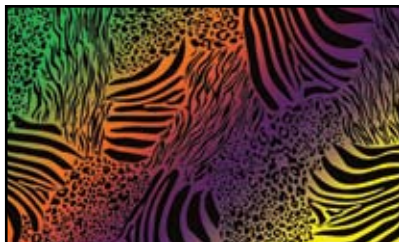

**Safari**  
P3982

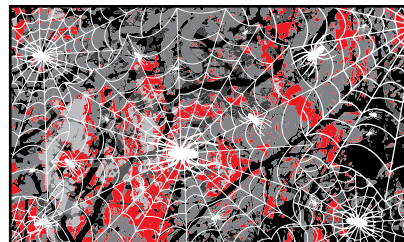

**Spider Web**  
P3983

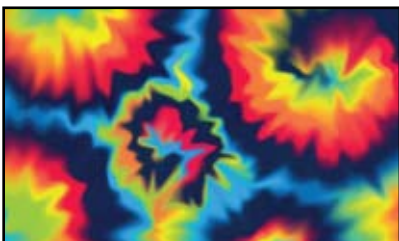

**Tie Dye**  
P3984



**Pink Camo**  
P3985

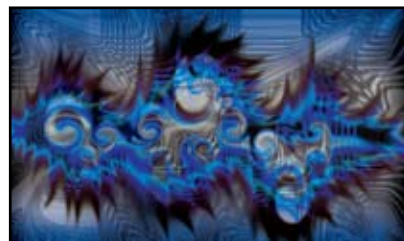

**Psychedelic**  
P3986



1. Use a wet sponge to adhere Body Skin.



2. Peel off backing sheet.



3. Use a wet sponge to smooth onto racer.

PineCar®

## Complete Paint Systems

\$8.99

Color does make a difference! This paint system includes everything you need, from sanding your racer to a paint job with a high gloss finish. Available in five hot racing colors, the system is ideal for finishing wood, plastic or metal parts. Included in this kit is sealer/paint, gloss finish, two accent colors, two brushes, plus sandpaper.

Sealer/Paint .8 fl. oz.

Gloss Finish .8 fl. oz.

Accent Paints .125 fl. oz.



**HOW-TO VIDEOS**  
pinecar.com



Racer shown was made with Designer Kit with Wedge The Avenger (P421) and Complete Paint System Cool Blue (P3955).



## Custom Finishing Kits

\$8.99

Use these kits to finish wood, plastic or metal parts. Each kit includes three grades of sandpaper (fine, medium and coarse), a sanding block, sealer/paint, gloss finish and an applicator. Available in twelve racing colors.

Sealer/Paint .8 fl. oz.,

Gloss Finish .8 fl. oz.

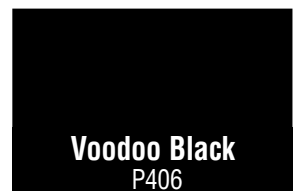
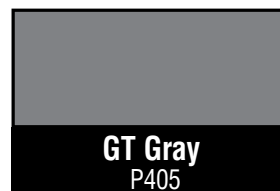
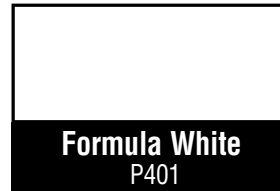

Racer shown was made with Custom Finishing Kit Competition Red (P409), Aerodynamic Pre-Cut Design The Blur (P3970) and Dry Transfer Decal Freedom Forever (P4019).

# Dry Transfer Decals

The fastest and easiest way to customize a racer. These decals are high quality graphics, numbers and letters. Transfer to any texture, and around contours, by rubbing them on with a dull pencil or burnisher. Sheet size:

4" x 5" \$5.49  
4" x 2 1/2" \$3.89



**HOW-TO VIDEOS**  
pinecar.com



Racer shown was made with PineCar Racer Basic Kit (P370), Designer Kit Thunderbolt (P416) and Dry Transfer Decals Stinger (P311).

PineCar®

**Sponsors & Numbers**  
P306 (4" x 5")

**Stripes & Flames**  
P307 (4" x 5")

**Hot Rod**  
P314 (4" x 5")

**Off Road**  
P315 (4" x 5")

**Drag Racer**  
P316 (4" x 5")

**Stockcar**  
P317 (4" x 5")

**Custom Designs**  
P318 (4" x 5")

**Formula**  
P319 (4" x 5")

**Dragonfire**  
P308 (4" x 2 1/2")

**Cobra**  
P309 (4" x 2 1/2")

**Magnum**  
P310 (4" x 2 1/2")

**Stinger**  
P311 (4" x 2 1/2")

**Spyder**  
P312 (4" x 2 1/2")

**Turbo**  
P313 (4" x 2 1/2")



Racer shown was made with Pre-Cut Design Truckster 4x4 (P3966), Dry Transfer Decals Custom Designs (P318) Custom Parts Eliminator (P341) and Drag Star (P331).

**NEW**



**Bad to the Bone**  
P4017 (4" x 5")



**Free Bird**  
P4021 (4" x 5")



**Flaming Dragon**  
P4018 (4" x 5")

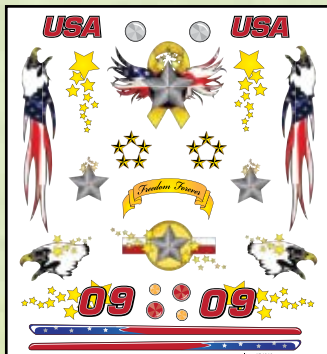

**Freedom Forever**  
P4019 (4" x 5")



**Rock Star**  
P4020 (4" x 5")



**Peace & Love**  
P4022 (4" x 2 1/2")



**Rockin' Diva**  
P4023 (4" x 2 1/2")



**Bold & Brave**  
P4024 (4" x 2 1/2")



**Faith & Honor**  
P4025 (4" x 2 1/2")

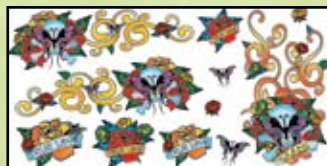

**True Love**  
P4026 (4" x 2 1/2")



Racer shown was made with  
Pre-Cut Design Stealth (P3968) and  
Dry Transfer Decals Bad to the Bone (P4017).

**Easy to Apply**



1. Rub decal sheet with burnisher or dull pencil.



2. Remove backing sheet.



# High-Gloss Dry Transfer Decals

Sheet size:

4" x 5" \$5.49

4" x 2 1/2" \$3.89

**HOW-TO VIDEOS**  
pinecar.com



Racer shown was made with Premium Kit Muscle Racer (P3948) and Dry Transfer Decals Freedom Runner (P4012).



**Scorpio**  
P4006 (4" x 5")

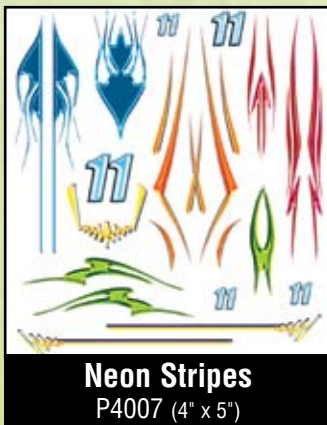

**Neon Stripes**  
P4007 (4" x 5")



**Blazin' Flames**  
P4008 (4" x 5")

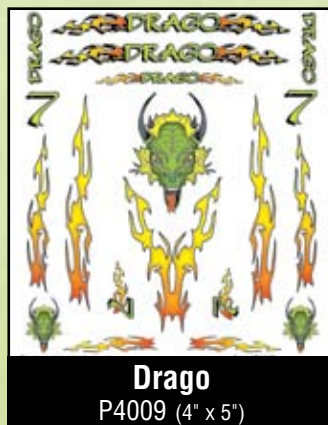

**Drago**  
P4009 (4" x 5")



**Racer Assortment**  
P4013 (4" x 2 1/2")



**Racer Accents**  
P4014 (4" x 2 1/2")

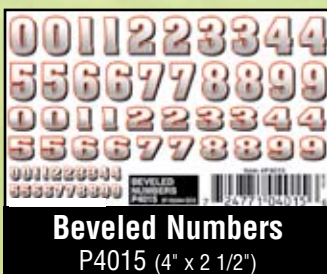

**Beveled Numbers**  
P4015 (4" x 2 1/2")



**Yellow Numbers**  
P4016 (4" x 2 1/2")



**Cool Blaze**  
P4010 (4" x 5")

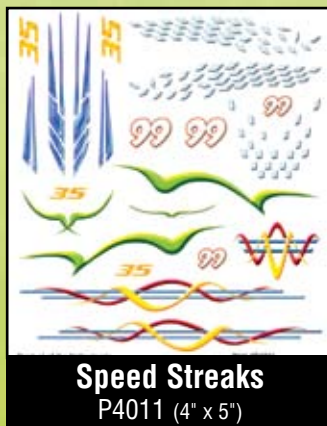

**Speed Streaks**  
P4011 (4" x 5")



**Freedom Runner**  
P4012 (4" x 5")

PineCar®

## Stick-On Decals

PineCar also offers Stick-On Decals. Cut them out, peel the backing sheet off and stick them on.

Sheet sizes:

4" x 5" \$3.99

4" x 2 1/2" \$2.99

**HOW-TO VIDEOS**  
pinecar.com



Racer shown was made with Pre-Cut Design Ferrari (P366) and Stick-On Decals Silver Shark (P325).



**Raptor**  
P320 (4" x 5")



**Heavy Metal**  
P321 (4" x 5")



**Road Rocket**  
P322 (4" x 5")

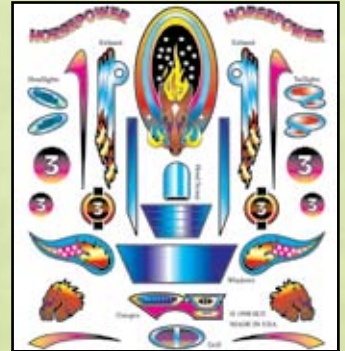

**Horsepower**  
P323 (4" x 5")



**Snake Eyes**  
P324 (4" x 2 1/2")



**Silver Shark**  
P325 (4" x 2 1/2")



**Lightning Rod**  
P326 (4" x 2 1/2")



**Turbo Ram**  
P327 (4" x 2 1/2")



**Born in the USA**  
P462 (4" x 5")



**Stars & Stripes**  
P463 (4" x 5")

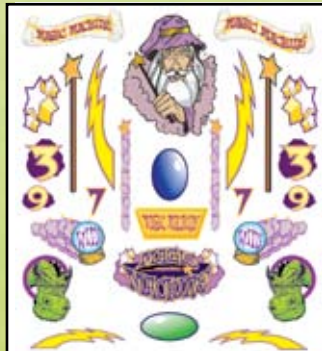

**Magic Machine**  
P464 (4" x 5")



**Captain Zoom**  
P465 (4" x 5")



1. Cut around decal.



2. Peel backing sheet off and stick on racer.

## Templates & Stick-On Decals

\$4.29

Take the guesswork out of building your winning racer. Each template provides an outline you can trace and follow. Also includes a sheet of cool decals to transform your racer into a customized machine.

*Racers, axles and wheels not included.*



**Track Twister**  
P475



*Racer shown was made with PineCar Racer Basic Kit (P370).*



**Hot Wings**  
P476



*Racer shown was made with PineCar Racer Basic Kit (P370).*

## Stick-On Details

\$2.19

The look of a customized detail job! Stick-On Details are adhesive-backed holographic sheets that you use to create a customized design for your racer. Make headlights, body contours, numbers, letters, pinstripes and more. Flashes of light and color are reflected as your racer sizzles down the track! Cut and stick on your design to create the ultimate look. Great for running boards and carbon hoods!

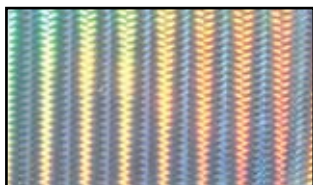

**Metallic Mirage**  
P3987



**Black Carbon**  
P3988

**HOW-TO VIDEOS**  
pinecar.com



*Racer shown was made with Pre-Cut Design GT Racer (P3965) and spoiler from Custom Parts Eliminator (P341).*



1. Draw your custom design on back of detail sheet.



2. Cut out design.



3. Test fit design for placement, then stick on racer.



### Custom Parts

\$3.99

Lead-free Custom Parts such as drivers, engines, pipes and rollbars easily transform a simple racer into an exciting work of pride! Simply attach with PineCar Formula Glue or Super Glue.

*Racers and wheels not included*

**HOW-TO VIDEOS**  
pinecar.com



Includes: 2 Exhaust Pipes, 2 Lights and 1 Rollbar (4pcs.)

**Dune Buster**  
P340



Includes: 2 Exhaust Pipes, 1 Engine and 1 Spoiler

**Eliminator**  
P341



Includes: 1 Windshield, 1 Seat, 2 Side Vents and 1 Spoiler

**Star Fire**  
P342



Includes: 2 Exhaust Pipes, 1 Engine, 1 Driver's Head, 1 Windshield and 1 Rollbar

**Formulator**  
P343

### Custom Parts With Decals

\$5.99

Lead-free Custom Parts With Decals contain castings and Dry Transfer Decals. They can be used to add realism to your racer. Simply attach Custom Parts with PineCar Formula Glue® or Super Glue.

*Racers and wheels not included*

**HOW-TO VIDEOS**  
pinecar.com



Includes: 2 Exhaust Pipes, 2 Lights and 1 Spoiler

**Baja Champ**  
P330



Includes: 2 Exhaust Pipes, 1 Rollbar and 1 Engine

**Drag Star**  
P331



Includes: 2 Exhaust Caps, 2 Side Vents and 1 Vertical Stabilizer

**Phantom**  
P332

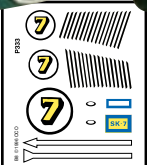

Includes: 2 Exhaust Pipes, 1 Engine and 1 Windshield

**Street Rod**  
P333

PineCar®

This warning applies to all products on this page.



**WARNING:** Choking Hazard! Small parts. Not intended for children under 3 yrs.

## Cockpits and Drivers

\$4.29

Either of these designs add humor and character to your racer. They give it unique detail and individuality. Paint parts, attach to racer and now they are ready to race.

Racers shown were made with PineCar Racer Wedge Kit (P369).



Includes: 1 Driver, 1 Cockpit, 1 Steering Wheel and 1 Shifter



**Mad Racer**  
P3920



Includes: 1 Driver/Cockpit and 1 Canopy



**Baron Von Gofast**  
P3921

## Canopy & Cockpit Sets P346

\$3.99

Give your racer a finished touch by using one of three different decals and canopies included in this package.



Racer shown was made with PineCar Racer Wedge Kit (P369).

## Windshield Kit P348

\$3.99

Add that finishing touch to any racer. Create one of several lead-free windshield designs. Kit includes a driver, roll bar, seat back and a sheet of black vinyl. Glue to racer with PineCar Formula Glue or Super Glue.



## Body Builder™ Kit P4036

\$9.99

Pump Up Your Racer's Physique for a Strong Showing! Easily make custom body styles by adding height, fenders, fins and other details to a block or wedge. Lightweight balsa wood is easy to cut and carve and adds minimal weight. PineCar Formula Glue included.

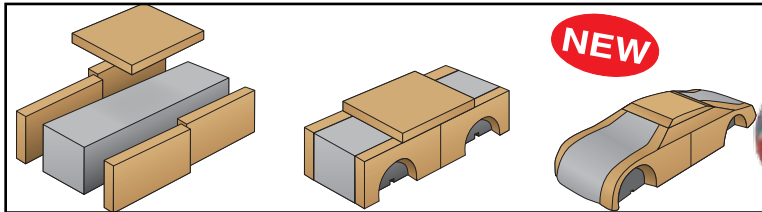

**NEW**



## Tools & Adhesives

From tools to glue, these products are especially formulated to help you create your winning racer!

### Racer Shaping Tools P3930

\$12.99

All the tools you need in one package! Coping saw and rasp help you transform a block of wood into a magnificent racer. Includes five different specialty blades for various cutting options: medium blade for wood, fine blade for wood or plastic, extra-fine blade for metal or wood, fine blade for metal and wood and a hacksaw blade for cutting metal. These tools can be used for other crafts. Length between blade pins is 6 1/2".



**HOW-TO VIDEOS**  
pinecar.com

### Performance & Conformity System P4035

\$24.99

**NEW**

Size up your car before race day! Portable scale and conformity gauge keep you up to speed on your racer's weight and dimensions. Quickly check car weight, overall width, width between wheels and track clearance. Use included mathematical formula or the simple chart to determine your car's center of gravity and adjust weight placement for optimum speed and stability. Batteries included. *Maximum weight: 14.1 oz./400 gr.*



PineCar®

### Micro-Polishing System

P4038  \$8.99

Micro-polish your axles for minimal friction. Beginning with the three-sided file, use this progressive polishing system to reduce friction for a smooth spin. Kit includes magnifier to monitor your polishing progress. For a racing edge, follow up with the Diamond Finishing Kit. (P4039).



**NEW**

### Diamond Finishing Kit

P4039  \$9.99

Give your axles a checker flag finish! For that winning edge and the slickest axle spin, use this specially formulated diamond compound as the final finish after the Micro-Polishing System. Even polishes watch crystal!



**NEW**

### Sanding Sealer and Wax

P3960  \$6.99

Apply Sanding Sealer prior to painting your racer. It saturates wood pores and creates a surface easily sanded to a flawless finish, ready to paint. Works exceptionally well with spraypaint. Wax the painted surface for a showroom shine.



*Truck shown was made with Pre-Cut Design Truckster 4x4 (P3966), Custom Parts Eliminator (P341) and Dry Transfer Decals Custom Designs (P318).*



**NEW**

### Body Putty P3928 \$3.59

Use to repair gaps, cuts or scratches on your racer. Works great as an all-over smoothing compound and sealer. Spatula included. .5 oz.



### Sandpaper Assortment P380 \$2.19

Includes two each of three grades of quality sandpaper: 220 grit (fine), 120 grit (medium) and 80 grit (coarse). The handy size fits around a small wooden block to smooth surfaces for painting.



**HOW-TO VIDEOS**  
pinecar.com

### Sanding Pads P3932 \$3.29

Two Sanding Pads – 220 grit (fine) and 100 grit (medium) – help you achieve a perfectly smooth finish before and during the painting process. These foam-backed pads mold to fit any object. They are reusable: clean with water. Can be used wet or dry.



**HOW-TO VIDEOS**  
pinecar.com

### Super Glue P381 \$1.99

Instantly bonds almost everything to anything. Ideal for attaching Custom Parts and designer details. .11 fl. oz./3.25 ml.



### Formula Glue® P384 \$2.99

A non-toxic, non-flammable, high-tack and fast-setting white glue that is compatible with metal, plastic and wood. .5 fl. oz./15 ml.



## Accessories

Use these accessories to improve racer performance and proudly display your hard work.

### Racing Wheels P347 \$3.79

Includes four replacement wheels, two one-piece axles, four nail-type axles and five hubcaps. Check with your group leader for local race rules (wheels and axles that do not meet specifications may be disqualified).



### Racer Display Stand \$6.99

P382

Preserves your racer in trophy-like splendor after the race. The sleek metal bracket holds any PineCar or SailBoat Racer, and mounts on a solid oak base.



### Show Wheels P349 \$7.99

Cast metal "mags" with rubber tires, designed for displaying your car before and after the race. These wheels are not intended for racing. Four nail-type axles are included.



### 5 Axles P457 \$1.49

These one-inch nail-type axles are for replacing damaged or lost axles. They meet BSA specifications.



 **CHOKING HAZARD** (see page 2) Not intended for children under 3 yrs.

**Wheel Turning Mandrel** P357  **\$3.79**

This mandrel holds wheels securely in a drill while removing parting seam for a smooth, fast-running racer. The package includes a two-piece mandrel and two grades of sandpaper: 220 grit (fine) and 120 grit (medium).



**HOW-TO VIDEOS**  
pinecar.com

**Axles & Polishing Kit** P359  **\$3.69**

Use this kit to improve your racer performance and reduce axle friction. It includes five BSA nail-type axles, a sheet of 600 grit (wet-or-dry) sandpaper and polishing pumice.



**HOW-TO VIDEOS**  
pinecar.com

**Hob-E-Lube® Dry Graphite Lubricant**  
P358 **\$3.99**

A fine, specially ground lubricant with Molybdenum that is safe on all surfaces and easy to use Molybdenum works like millions of microscopic ball bearings and is a racer's advantage.  
.23 oz./6.5 gr.

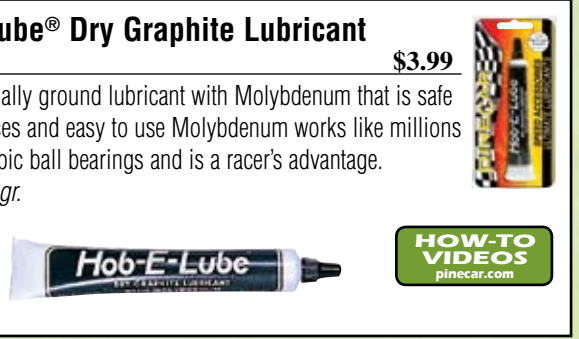

**HOW-TO VIDEOS**  
pinecar.com

**Dry White Teflon\* With Cling**  
P355 **\$3.99**

This fine, non-staining Teflon\* lubricant has an additive that clings to smooth surfaces. Use where local rules prohibit the use of graphite.  
.125 oz./3.5 gr.



**HOW-TO VIDEOS**  
pinecar.com

\*Teflon is a DuPont Registered Trademark

**XLR8 Ultra Graphite™**  
P4037  **\$9.99**

The "Got-to-have-it" graphite for the serious competitor! Tested and true, XLR8 amps your racer's speed to the max. Stainless steel-plated needle applicator for precision placement.  
.23 oz./6.5 gr.



**NEW**

**COG System™\***  
P3918  **\$10.99**

Harness the physics of speed. New patent-pending center-of-gravity system. Works with any car to distribute weight to achieve desired center of gravity. Test racer speed and then fine-tune with included adjustment tool.

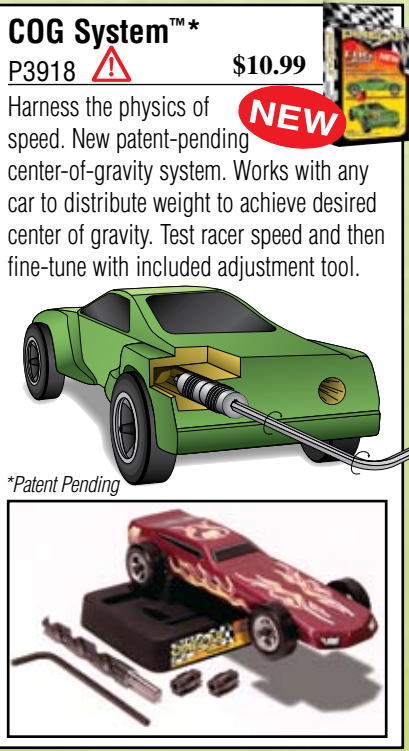

**NEW**

\*Patent Pending

**Featherweight Customizing Kit**  
P3929  **\$6.99**

Have the most original car on the track! Design and create lightweight, custom car parts, decorations and figures that add minimal weight to your racer.

*One package of modeling clay will add no more than 1 ounce to car weight.*



**NEW**

**Speed Kit** P356  **\$12.99**

Use this kit to improve the overall performance of your racer. It includes Hob-E-Lube Dry Graphite Lubricant, a Wheel Turning Mandrel, Axles & Polishing Kit and a lead-free Bar Weight with screws. Kit offer savings over purchasing components separately.



**Wheel Alignment Tool** P456 **\$4.99**

Use this tool to make certain your racer meets all racing specifications. Especially helpful when building your racer. It checks axle slots for alignment, clearance between wheel and racer body, camber and toe-in and out. It also measures racer length, width and clearance between bottom of racer and track.

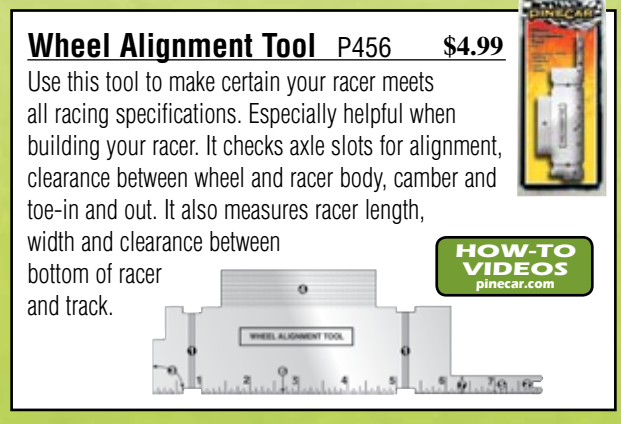

**HOW-TO VIDEOS**  
pinecar.com

 **CHOKING HAZARD** (see page 2) Not intended for children under 3 yrs.

This warning applies to all products on this page. **WARNING:** Choking Hazard! Small parts. Not intended for children under 3 yrs.

**HOW-TO VIDEOS**  
pinecar.com

## Weights

Weights are a major factor in building a winning racer. The heavier your racer, the faster it goes. Our lead-free weights are incremental and scored. Sections can be broken off, even on race day.

### Round Weights and Combo Weights

**\$3.89**

Insert lead-free Round and Combo Weights into the body of the racer, or attach Combo Weights to the sides.



Approx. 1 oz. each

**Round P350**

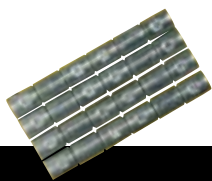

Approx. 1/2 oz. each

**Combo P354**

### Tapered, Strip and Bar Weights

**\$3.89**

Attach or countersink these weights under your racer. Pre-drilled holes make installation easy. Screws included.



Approx. 2 oz.

**Tapered P351**



Approx. 1 oz. each

**Strip P352**



Approx. 2 oz.

**Bar P353**

### Adjustable Stick-On and Designer Stick-On Weights

**\$3.89**

Attach lead-free Stick-On Weights to the bottom of your racer. For a custom look, attach Designer Stick-On Weights to the sides. Two-sided tape included.

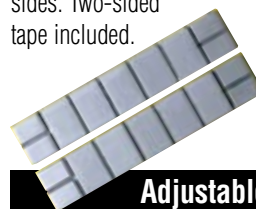

Approx. 1 oz. each

**Adjustable Stick-On P378**



Approx. 1 oz. each

**Designer Stick-On P379**

### Tungsten Incremental Weights

Almost 3x as dense as traditional weights, tungsten provides more control over precise weight distribution. Incremental weight design allows you to weigh your racer in exact 1/16-ounce increments to the maximum weight allowed.



**NEW**

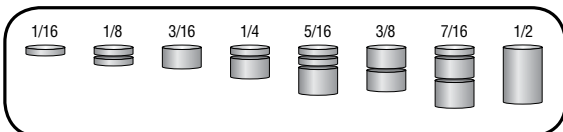

**\$9.99**

**2 oz. Cylinder Weights P3914**



**\$13.99**

**3 oz. Cylinder Weights P3915**



**\$10.99**

**2 oz. Plate Weights P3916**



**\$14.99**

**3 oz. Plate Weights P3917**

### Chassis Weights™

**\$4.69**

Available in four detailed styles, lead-free Chassis Weights expertly replicate the underbody of real cars. Weights are simple to install and incremental to allow easy compliance with weight requirements.

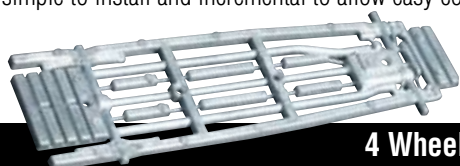

Approx. 2 oz.

**4 Wheel Drive P3910**

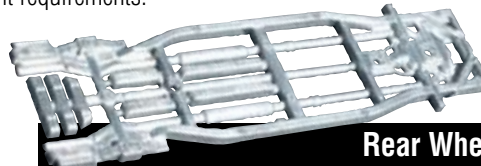

Approx. 2 oz.

**Rear Wheel Drive P3911**



Approx. 2 oz.

**Maximum Torque P3912**



Approx. 2.25 oz.

**Rocket Car P3913**

PineCar®



**PineCar Race Package** P459 **\$130.00**

Purchase this complete package. It includes everything you need to hold a race.

**Package contents:**

- **NEW!** Digital Weigh-In Scale
- PineCar Speedway (32-foot, four-lane track)
- Conformity Gauge
- Program Guide
- Elimination Charts
- Registration Forms
- Stick-On Number Labels
- Winner Ribbons
- Participant Certificates
- Decorative Pennants

*Ideal for scouts, schools and youth, camp and church groups.*

**HOW-TO VIDEOS**  
pinecar.com



**PineCar Speedway®** P455 **\$100.00**

This regulation, four-lane track is 32-feet long and made of lightweight, durable cardboard. It has a starting gate, finish line and braking section. The tower sports a bright, colorful racing motif. Assembles and disassembles quickly, and can be stored neatly in the reusable carton for next year's race.

**Elimination Charts, Forms and Stickers** P453 **\$3.00**

Double Elimination Chart, Registration Forms and Stick-On Numbers are used for tracking race participants, logging and numbering up to 150 racers.



**NEW! Weigh-In Digital Scale with Conformity Gauge** P452 **\$19.99**

This pocket-sized digital scale goes wherever the derby takes you! Cars straddle the scale, so they won't roll off the scale and destroy your hard work! The scale weighs items up to 400 grams (14.110 oz.). The protective cover can be used as a self-contained weighing surface for small parts and the readout is a backlit LCD display. Scale dimensions are 4" x 3" x 0.75" and operates using two AAA batteries (included). The Conformity Gauge makes race day check-in and registration a breeze! Quickly check car length, overall width, width between the wheels and the car's ground clearance.

**Decorative Racing Pennants** P429 **\$9.00**

25-foot string of black and white 12" x 18" plastic pennants.

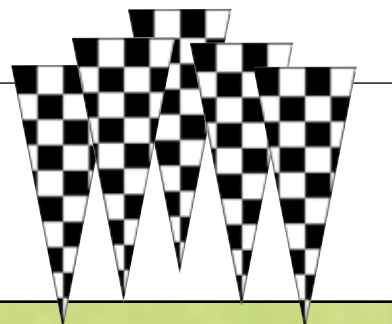

Bulk packs available. Call 573-346-5555 for more information.

**CERTIFICATES, RIBBONS AND TROPHIES**

<b>Participants Certificates</b> Certificates for 25 race participants	P425	<b>\$3.00</b>
<b>Participant Ribbons</b> Ten green ribbons	P426	<b>\$3.75</b>
<b>Winner Ribbons</b> Three racer and three craftsman (1st, 2nd and 3rd)	P427	<b>\$3.75</b>
<b>Race Official/Special Award Ribbons</b> Ten yellow ribbons	P428	<b>\$3.75</b>
<b>4" Special Award Trophy</b>	P430	<b>\$5.50</b>
<b>7" Third Place Trophy</b>	P431	<b>\$7.50</b>
<b>8" Second Place Trophy</b>	P432	<b>\$8.00</b>
<b>9" First Place Trophy</b>	P433	<b>\$8.50</b>
<b>10" Deluxe Third Place Trophy</b>	P434	<b>\$12.50</b>
<b>11" Deluxe Second Place Trophy</b>	P435	<b>\$13.50</b>
<b>12" Deluxe First Place Trophy</b>	P436	<b>\$14.50</b>



**SailBoat Racer® Kit SR470**  **\$6.49**

This kit is easy to assemble. Young skippers will have fun creating their own boats for exciting races. The SailBoat Racer Kit includes a pre-cut wood hull and mast, sail, lead-free rudder and metal keel and meets BSA specifications. A variety of decals are available for decorating your SailBoat Racer. For a customized look, use Body Skin Custom Transfers instead of paint.



Racer Kit shown with SailBoat Racer Decal Viking (SR486).

Racer Kit shown with Body Skin Custom Transfer Freedom Flag (P3980).

**SailBoat Racer® Decals**

**\$5.49**

Decals come in bright, nautical colors and are designed to fit hulls, decks and sails of SailBoat Racers. Dry Transfer Decals are easily applied for professional-looking models. Sheet size: 4" x 5".

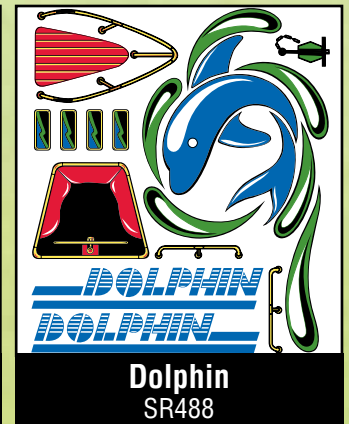
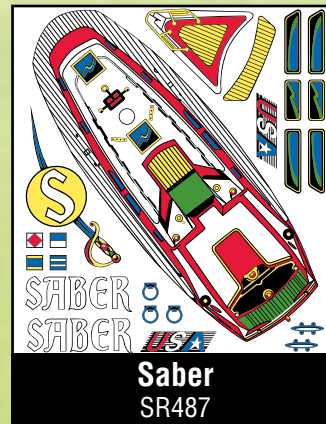
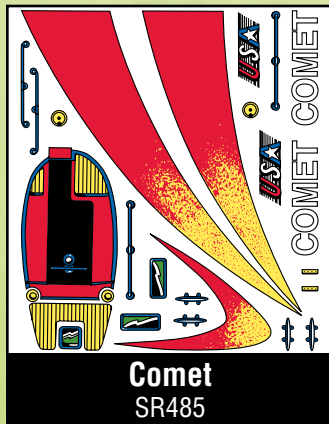

CERTIFICATES, RIBBONS AND TROPHIES		
<b>Participants Certificates</b> Certificates for 25 race participants	SR437	\$3.00
<b>Participant Ribbons</b> Ten green ribbons	SR438	\$3.75
<b>Winner Ribbons</b> Three racer and three craftsman (1st, 2nd and 3rd)	SR439	\$3.75
<b>Race Official/Special Award Ribbons</b> Ten yellow ribbons	SR440	\$3.75
<b>4" Special Award Trophy</b>	SR441	\$7.00
<b>7" Third Place Trophy</b>	SR442	\$9.00
<b>8" Second Place Trophy</b>	SR443	\$9.50
<b>9" First Place Trophy</b>	SR444	\$10.00
<b>10" Deluxe Third Place Trophy</b>	SR445	\$14.00
<b>11" Deluxe Second Place Trophy</b>	SR446	\$15.00
<b>12" Deluxe First Place Trophy</b>	SR447	\$16.00



 **CHOKING HAZARD** (see page 2) Not intended for children under 3 yrs.  
See page 146 for merchandiser.



*Dioramas • School Projects • Displays*

**SCENE<sup>+</sup>ARAMA<sup>®</sup>**

2010

# Scene-A-Rama School Projects



A line of products specifically designed to help students build dioramas, displays and various arts and crafts. Scene-A-Rama provides easy-to-use materials and loads of helpful video demonstrations, ideas, tips and techniques. With Scene-A-Rama, you can create an A+ project every time!

- **For any subject** – Social Studies, Math, Science, Language Arts, History, etc!
- **For any student** – grade school to high school, college and beyond!
- **For any project** – volcanoes, masks, Indian villages, storybooks, mobiles, missions, pyramids and much more!



## Project Book SP4170

\$10.99

If you can imagine it, you can make it! The Project Book provides the inspiration and motivation to build amazing dioramas and displays for an A+ school project.

- **Bright, full-color photos and illustrations**
- **Loads of project ideas**
- **Modeling basics, tips and techniques**

84 full-color pages



## ShowBox™ SP4167

\$4.99

The ShowBox is compact and great for shoebox dioramas, displays and more. Build the diorama inside and paint or decorate the outside.

- **Made of sturdy, durable material**
- **Two labels included for project identification**
- **Will endure the bus ride to and from school**

Overall Size: 10" x 13" x 4 1/2"  
Project Area: 8 1/2" x 13" x 4 1/2"



**“Use Your Imagination”**



Displays



Storybook Dioramas

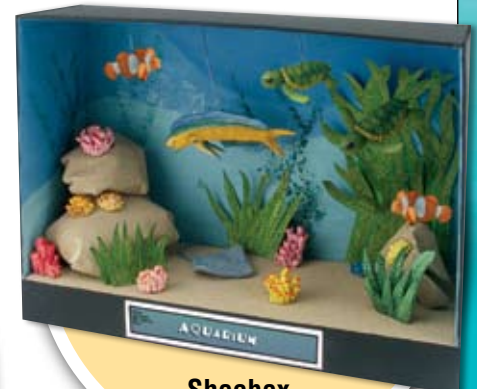

Shoebox Dioramas

## Project Base & Backdrop

The Project Base is the perfect foundation for your diorama or display. The Backdrop fits snugly into the grooves on the molded, black base and provides a durable backdrop for painting, decorating and labeling.

- Available in Large and Small
- Backdrop can be cut to any shape
- Molded placard on Base for labeling your project
- Includes easy instructions and three labels for project identification

**Large** SP4165 **\$7.99**

Overall Size: 18" w x 12 1/2" d x 13 1/8" h  
Project Area: 16 1/4" w x 10 3/4" d x 11" h

**Small** SP4166 **\$5.99**

Overall Size: 12 1/2" w x 9 1/4" d x 9 5/8" h  
Project Area: 10 3/4" w x 7 3/8" d x 7 1/2" h



Patented Pending

## "Use Your Imagination"



**Displays**



**Backdrops**



**Shadowboxes**



**Profiles**

This warning applies to all products on this page.  **WARNING: Choking Hazard! Small parts. Not intended for children under 3 yrs.**

## Diorama Kits (flat surfaces)

These two kits include everything you need to create flat grassy or sandy terrain landscape for scenic dioramas. Their surfaces are great for adding buildings and structures.



### Plant Wild Grass

Wild Grass can be trimmed to make tall grasses on land or standing in water.



### Plant Trees

Trees give your diorama depth and realism.



### Foliage Fiber

Make vines and ivy using Foliage Fiber.



### Add Bushes

Add realistic bushes and other foliage to make your diorama come alive.

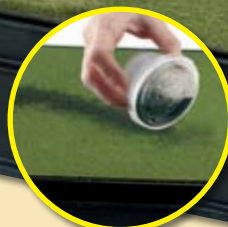

### Add Accents

Sprinkle Accents for dirt paths, low grasses and foliage highlights.



### ReadyGrass Sheets

Make grassy or sandy surfaces. Glue with Sticky Bond!

*Base sold separately.*

## Basic Diorama Kit SP4110

**\$16.99**

Use the Basic Diorama Kit to create dioramas or displays where a flat, landscaped surface is your main focus. The kit contains everything you need to make plains, prairies, grasslands, farmlands, woods and meadows.

- Native American Villages
- Settlements
- Castles

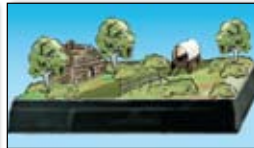

**HOW-TO VIDEOS**  
scenearama.com

## Desert Oasis Diorama Kit SP4112

**\$16.99**

Use the Desert Oasis Diorama Kit to create dioramas or displays where a flat sand surface is needed. It contains everything you need to make prehistoric habitats, shorelines, wastelands, beaches, missions or desert projects where sand is your main focus.

- Dinosaur Habitats
- Missions
- Pyramids



This warning applies to all products on this page.



**WARNING: Choking Hazard! Small parts. Not intended for children under 3 yrs.**



## Diorama Kits (mountains and water)

These two kits include everything you need to create mountains or rolling hills for scenic dioramas. The Mountain Diorama Kit features rock outcroppings while the Water Diorama Kit features water areas.

### Add Foliage

Make your diorama come alive with realistic-looking bushes and shrubs.



### Rocks

Add single rocks, outcroppings, cliffs, riverbanks and more.

### Newspaper Wads

Build land contours into hills, mountains or even volcanoes, then cover with Plaster Cloth.



### Earth Undercoat

Create an earth-colored base for all of your landscape using our easy technique.



### Plaster Cloth

Create a hard shell land surface for grasses, bushes, trees and other foliage.



### Side Panels

Side Panels create the perimeter and form your diorama contours.



*Base sold separately.*

## Mountain Diorama Kit SP4111

**\$19.99**

Use the Mountain Diorama Kit to create dioramas or displays where mountains or hills are your focus. A volcano tube is included for building an erupting volcano.

- Wind and water erosion
- Caves
- Volcanoes

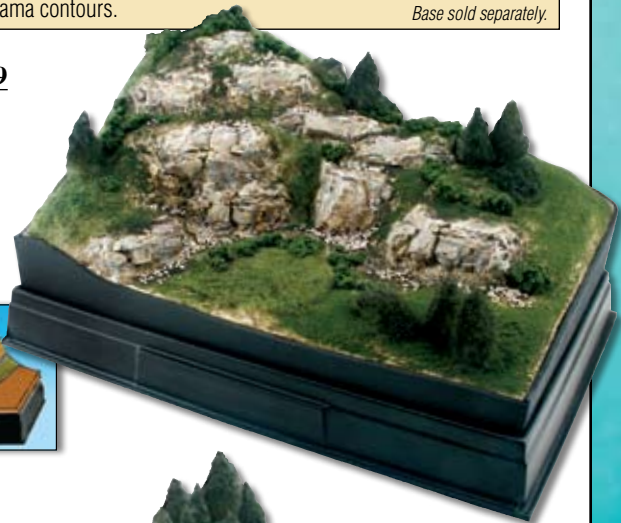

## Water Diorama Kit SP4113

**\$19.99**

Use the Water Diorama Kit to create dioramas or displays with water as the main focus. It includes everything you need to make still or moving water.

- Ponds
- Waterfalls
- Rivers



This warning applies to all products on this page.



**WARNING:** Choking Hazard! Small parts. Not intended for children under 3 yrs.

## Accents

Use these five Accents to enhance any diorama or display. Each one adds a specific feature to your project. Use Accents on an existing diorama, a ReadyGrass Sheet or with a Diorama Kit.

- Add grasses, bushes, vines and other foliage
- Make, color and add realistic rock formations
- Create spectacular waterfalls, rapids, ponds and lakes
- Add an assortment of cacti and other desert plants
- Make snowdrifts, snow dustings, icy ponds, icicles and more!



### Foliage & Grasses SP4120

**\$9.99**

Use Foliage & Grasses if you want to enhance your diorama or display with grasses, bushes, ivy, vines and other foliage. Includes products to build trees and add basic scenery.

- Short and tall grasses
- Flowers and highlights
- Roads and paths

#### Kit Contents:

- |                  |                       |                     |
|------------------|-----------------------|---------------------|
| • Foliage Fiber  | • Forest Green Accent | • Spray bottle      |
| • Bushes         | • Project Glue        | • Sifter            |
| • Green Grass    | • Wild Grass          | • Easy Instructions |
| • Yellow Flowers |                       |                     |



*Diorama shown built with kit contents and additional materials, sold separately.*

### Rock Making Kit SP4121

**\$9.99**

Use this kit if you want to enhance your diorama or display with rocky areas. It includes everything needed to add rock outcroppings, rock debris, lava or cliffs.

- Lava flows
- Rock outcroppings
- Creek banks
- Rock debris (Talus)

#### Kit Contents:

- |                   |               |                     |
|-------------------|---------------|---------------------|
| • Rock Mold       | • Talus       | • Stir Stick        |
| • Casting Plaster | • Mixing Tray | • Project Glue      |
| • Rock Colors     | • Foam Brush  | • Easy Instructions |



*Diorama shown built with kit contents and additional materials, sold separately.*

### Ripplin' Water Kit SP4122

**\$9.99**

Use this kit if you want to enhance your diorama or display with still or moving water. It includes everything needed to create water details.

- Rapids
- Waterfalls
- Frozen water

#### Kit Contents:

- |                   |                 |                     |
|-------------------|-----------------|---------------------|
| • Realistic Water | • Foam Brush    | • Easy Instructions |
| • Water Effects   | • Stir Stick    |                     |
| • Water Undercoat | • Release Paper |                     |



*Diorama shown built with kit contents and additional materials, sold separately.*



This warning applies to all products on this page.



**WARNING:** Choking Hazard! Small parts. Not intended for children under 3 yrs.

### Winter Effects SP4123

\$9.99

Use Winter Effects if you want to enhance your diorama or display with cold-weather detail. It includes everything needed to create frigid, snowy or icy details.

- Snowdrifts
- Light snow dustings
- Icicles

#### Kit Contents:

- |               |              |                     |
|---------------|--------------|---------------------|
| • Ice Effects | • Foam Brush | • Release Paper     |
| • Snow Flakes | • Sifter     | • Easy Instructions |
| • Snow Base   | • Stir Stick |                     |

*Diorama shown built with kit contents and additional materials, sold separately.*



### Desert Plants SP4124

\$9.99

Use Desert Plants if you want to enhance your diorama or display with desert cacti or vegetation. It includes everything needed to create arid climate or dry desert details.

- Make brightly flowering cactus
- Add tall Wild Grasses
- Model sage and scrub brush

#### Kit Contents:

- |                        |                  |                     |
|------------------------|------------------|---------------------|
| • 2-Organ Pipe         | • 3-Barrel Cacti | • Foliage Fiber     |
| • 8-Saguaro Cacti      | • Red Flowers    | • Project Glue      |
| • 6-Columnar Cacti     | • Yellow Flowers | • Easy Instructions |
| • 2-Prickly Pear Cacti | • Wild Grass     |                     |

*Diorama shown built with kit contents and additional materials, sold separately.*



## Accessories

Create arts and crafts projects, dioramas or add defining features to an existing project. These kits contain easy-to-use materials to create backdrops and structures, sculpt details and terrain, mold rocks or add landscape.

### Sculpting Kit SP4131

\$9.99

Sculpt, paint, detail and add texture to figures, animals, birds, planets and much more! Bring your creature to life with Fun Fur!

- Sculpt plants and animals
- Make shapes

#### Kit Contents:

- |                  |                |                     |
|------------------|----------------|---------------------|
| • Sculpting Clay | • Paintbrush   | • Project Glue      |
| • Sculpting Tool | • Fun Fur      | • Easy Instructions |
| • Project Paints | • Project Wire |                     |



### “Use Your Imagination”



Furry Animals



Shapes



Ocean Life

This warning applies to all products on this page.



**WARNING:** Choking Hazard! Small parts. Not intended for children under 3 yrs.

### Horizon & Detail Kit SP4132

\$9.99

Create spectacular backgrounds! Paint beautiful horizons and make three-dimensional backgrounds with Plaster Cloth, Foliage Fiber and Puffy Clouds. Add landscape and create realistic trees!

- Make backgrounds for any scene
- Make and suspend clouds
- Create textured effects

#### Kit Contents:

- |                  |                |                     |                     |
|------------------|----------------|---------------------|---------------------|
| • Plaster Cloth  | • Green Grass  | • Paintbrush (1/2") | • Easy Instructions |
| • Project Paints | • Puffy Clouds | • Paintbrush (1/8") |                     |
| • Foliage Fiber  | • Project Wire | • Project Glue      |                     |



3-D Backdrop

### “Use Your Imagination”

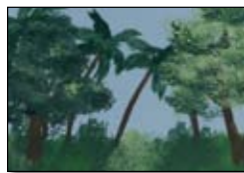

Diorama shown built with kit contents. Project Base & Backdrop sold separately.

### Building & Structure Kit SP4130

\$9.99

Use an assortment of materials to construct buildings and structures for your diorama or display. Create and add special textures using simple techniques explained in easy-to-follow instructions.

- Geometric shapes
- Pyramids, tepees
- Covered wagons
- Missions and much more!



#### Kit Contents:

- |                  |                      |                |                     |
|------------------|----------------------|----------------|---------------------|
| • Project Boards | • Clear Plastic      | • Black Paper  | • Project Glue      |
| • Project Cloth  | • Construction Board | • Ribbed Board | • Easy Instructions |
| • Project Sticks | • White Plastic      | • Project Wire |                     |

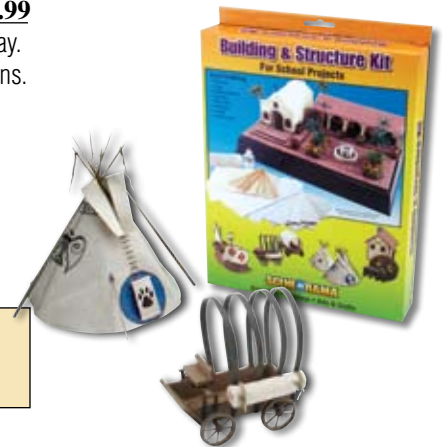

#### Building Textures:

You can make a wide variety of building textures with simple techniques (explained in package instructions).

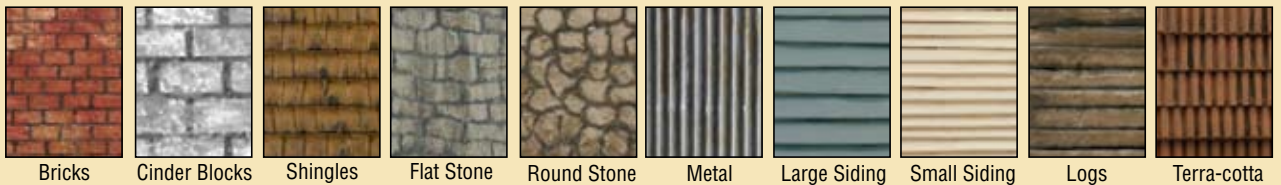

### “Use Your Imagination”



Missions



Stage Sets



Castles

This warning applies to all products on this page.



**WARNING:** Choking Hazard! Small parts. Not intended for children under 3 yrs.

### ReadyGrass® Sheets\*

\$3.99

Making flat, grassy areas or sandy surfaces on projects and dioramas is as easy as rolling out a ReadyGrass Sheet. They also work great as a display surface for your Project Base & Backdrop. *Each Sheet is 10 3/4" x 16 1/4".*

- Scrape turf off to make areas for roads, water and sidewalks
- Create desert landscape, beaches or shorelines



Summer Grass (SP4160)



Green Grass (SP4161)



Desert Sand (SP4162)

\* Patent Pending

### Trees

\$8.99

These four tree types model trees located most anywhere worldwide: Green Deciduous, Autumn Deciduous, Conifer and Palm. Install trees on your diorama or display with Project Glue or Sticky Bond, or place temporarily using the included bases.

- Each tree comes with a removable base
- Place temporarily or plant permanently



Deciduous Trees

SP4150 - 4/pkg. (2"-3")



Conifer Trees

SP4151 - 4/pkg. (4"-6")



Palm Trees

SP4152 - 6/pkg. (4"-5")



Autumn Trees

SP4153 - 4/pkg. (2"-3")

### Plaster Cloth SP4140

\$7.99

Plaster Cloth is versatile, fun and easy to use! Apply wet Plaster Cloth to newspaper wads, balloons and other forms to make lightweight, hard shell land terrain, masks and other shapes. *8 in. x 11 1/4 ft. roll.*

- Create holiday ornaments
- Make bright, colorful masks
- Use to form anatomy shapes



### "Use Your Imagination"

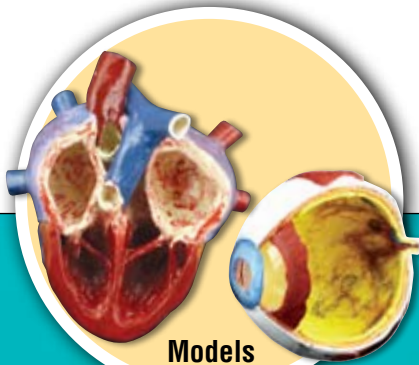

Models



Masks



Crafts

**Casting Plaster SP4141** **\$3.99**

Use Casting Plaster to make rocks, lava and casts of almost anything. Just mix according to easy package instructions.

8 oz. package.

- Rock outcroppings and cliffs
- Make lava flows
- Cast fossils, animal paw prints and tire tracks



**Lava Flows**



**Animal Prints**

**Scene Setters**

Bring your school projects and dioramas to life! Scene Setters are collections of themed sets of people, animals and a variety of specialized items sized just right for dioramas, displays and other projects. You will find fun, educational information included on the packaging of each set of Scene Setters.



**Egyptian Culture**  
SP4341

**\$8.99**

**Castle Dwellers**  
SP4342

**\$8.99**

**Native Americans**  
SP4343

**\$8.99**



**Native American Hunt**  
SP4344

**\$8.99**

**American Civil War Soldiers**  
SP4345

**\$8.99**

**Marine Life**  
SP4347

**\$9.99**

**Alternative Energy**  
SP4348

**\$9.99**

**African Wildlife**  
SP4346

**\$9.99**

**North American Wildlife**  
SP4349

**\$9.99**

**Prehistoric Life**  
SP4350

**\$9.99**

**Adhesives**

These Adhesives were formulated specifically for the Scene-A-Rama product line. Both are non-toxic and multipurpose adhesives with special properties.

**Project Glue** SP4142 **\$3.99**

Project Glue is great for gluing trees, bushes, paper and more to your school project. This glue comes in a plastic squeeze bottle with a twist top for easy application.  
3 fl. oz.



**Sticky Bond**® SP4143 **\$3.99**

Sticky Bond is a contact adhesive, perfect for attaching ReadyGrass Sheets to Project Bases. It is multipurpose glue that comes in a plastic bottle with a brush applicator.  
2 fl. oz.



This warning applies to all products on this page.



**WARNING:** Choking Hazard! Small parts. Not intended for children under 3 yrs.

## Project Packs

Create A+ school projects with Project Packs. Build science or art fair displays, produce museum-quality dioramas or just have fun on a rainy day! The included materials and a little creativity are all you need to have fun and easily design and build that A+ project!

Every kit includes a Base & Backdrop, all the project materials, instructions and a fun educational activity booklet!

*Project Packs™*

HOW-TO  
VIDEOS  
scenearama.com



### **Native American Village** SP4280

**\$29.99**

Duplicate your favorite Native American village or use your imagination and model your own. Realistic Water, landscape and trails make your tepee scene come alive with the spirit of the people who lived there!

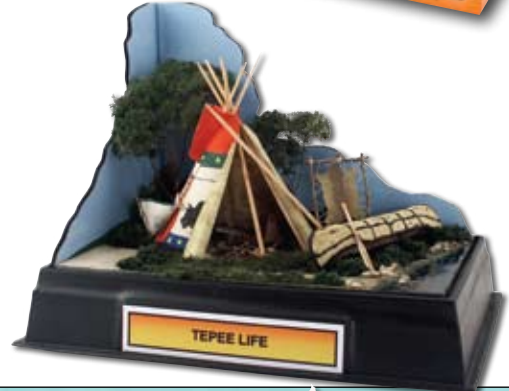

### **Erupting Volcano** SP4281

**\$29.99**

Form a cinder cone, caldera, cutaway or active island volcano! Use your imagination, along with all the trees, bushes and an eruption mixture for an explosion of fun!



### **Creative Mask & More** SP4282

**\$29.99**

Model a mask, sculpture, art project, ornament or other awesome creation. Wet the fun, flexible fabric, let it dry and harden and then enhance with colorful paint and decorative details.



### **Cell Structure** SP4283

**\$29.99**

Create your own, unique microscopic world! Plant, animal, bacteria cell...you decide! Choose your cell type and start modeling a cool, scientific project with the fun and easy-to-use materials!



This warning applies to all products on this page.  **WARNING:** Choking Hazard! Small parts. Not intended for children under 3 yrs.

## Classroom Packs

**Classroom Packs™**

Classroom Packs include everything needed to create projects that engage students' interest in the lesson, reinforce what they have learned and foster a fun educational environment! Each pack contains a teacher's guide and the materials for 12 complete projects. Projects are designed to aid students in meeting National Education Standards.

**HOW-TO VIDEOS**  
scenearama.com



### **Tepee Village** SP4250

**\$94.99**

This four-session project allows students to create their own little village using the knowledge learned in their Early American studies - fun, hands-on planning and design inspires students to remember the lesson!

This project is designed to aid students in meeting the expectations of the National Social Sciences Standards.



### **Erupting Volcano** SP4251

**\$109.99**

This four-session project makes any classroom explode with total student involvement! Create fun, interactive volcanoes that actually erupt, sending student knowledge and retention skyrocketing!

This project is designed to aid students in meeting the expectations of the National Science Education Standards for Earth Sciences.



### **Creative Mask** SP4252

**\$99.99**

This three-session project helps students learn cultural influences and artistic design - all rolled into one cool, creative and stimulating school project. From functional to decorative, your class will come alive with unique, fun masks!

This project is designed to aid students in meeting the expectations of both the National Standards for Arts Education and National Social Sciences Standards.

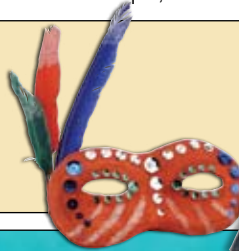

### **Cell Structure** SP4253

**\$99.99**

This five-session project allows students to create their own cell, according to the class lesson plan. From the nucleus to the ribosome, reinforce the fundamental elements of any cell type!

This project is designed to aid students in meeting expectations of the National Science Education Standards for Life Sciences.





*Quality Brands for Retail Stores*

**WOODLAND SCENICS®**

Quality Brands

2010

## Merchandisers and Assortments

Our merchandisers attract customer attention with bright headers and sellable products. These compact and space-saving merchandisers, can be set on the floor, countertop or shelves, or hung on pegboard or slat wall. Our merchandisers are easy to assemble and have reorder tags for easy replenishment of sold-out products. When purchased with an assortment, offsetting free goods are offered with most merchandisers.

### SUBTERRAIN®

- SubTerrain Merchandiser & Assortment** ..... UST6026
- SubTerrain Expansion Merchandiser & Project Foam Assortment** .. UST6028
- SubTerrain Expansion Merchandiser & Assortment** ..... UST6029
- SubTerrain Merchandiser** ..... ST1490

The SubTerrain Merchandiser displays over 30 different products from the SubTerrain System, including foam components, Plaster Cloth, Track-Bed, a manual and video, plus all the tools and adhesives needed. The merchandiser stands on the floor. Knocker Test Board included.  
32" w x 24" d x 88" h

- SubTerrain Display Assortment** ..... ST1495

- SubTerrain Display Half Assortment** ..... ST1495H

- SubTerrain Expansion Merchandiser** ..... ST1491

The Expansion Merchandiser has adjustable shelves and allows your SubTerrain Merchandiser to grow. The merchandiser stands on the floor.

15 1/2" w x 24" d x 53" h

- Expansion Assortment** .... ST1492

- Project Foam Assortment** ..... ST1497



UST6028 Merchandiser & Assortment

UST6026 Merchandiser & Assortment

UST6029 Merchandiser & Assortment

Product descriptions on pages 4, 6-9, 12 and 102.

*SubTerrain Merchandiser shown with two Expansion Merchandisers.*

### TRACK-BED™

- Track-Bed Roll Merchandiser & Assortment** ..... UST6025

**Track-Bed Roll Merchandiser** ..... ST1489  
Merchandiser holds Track-Bed Rolls, Super Sheets, Foam Tack Glue and Foam Nails. This merchandiser can stand on the floor or be hung on pegboard. Knocker Test Board included.

31" w x 14" d x 45" h

- Track-Bed Roll Assortment** ..... ST1466

- HO/O & N Scale Sheet Assortment** ..... ST1465

- HO Bulk Pack Strip Assortment** .... ST1498

- N Bulk Pack Strip Assortment** ..... ST1499

- O Bulk Pack Strip Assortment** ..... ST1496



UST6025 Merchandiser & Assortment

Product descriptions on pages 8 and 12.

### TERRAIN

- Terrain Merchandiser & Assortment** ..... UC6006

- Terrain Center Merchandiser** ..... C1299

Merchandiser is a spinning floor display, which holds more than 60 Terrain System products. It has a colorful header and assembles easily.

24" w x 24" d x 82" h

- Terrain Display Assortment** ..... C1295A



UC6006 Merchandiser & Assortment

Product descriptions on pages 4, 9, 14-19 and 26.

### LANDSCAPE

- Landscape Merchandiser & Assortment** ..... ULS6015

- Landscape Center Merchandiser**... LS2001

Merchandiser displays 104 different scenery products, is a modular floor spinner with a full-color header, or can be mounted on pegboard.

31" w x 31" d x 88" h Floor Spinner or

72" w x 84" h Pegboard Display

- Landscape Assortment** ..... LS2020



Pegboard Display

Product descriptions on pages 4, 13, 19-26 and 38-39.

ULS6015 Merchandiser & Assortment



### SCENERY CLINIC

- Scenery Clinic** ..... LK958

Use for in-store demonstrations and/or interactive clinics. Includes complete step-by-step instructions, an instructional DVD and all the materials necessary to paint and landscape six mountain dioramas.





## ARCHITECTURAL LANDSCAPE

- Architectural Model Landscape Assortment.....LS2011
- Architectural Scale People Assortment.....A2012



Architectural Model Landscape Assortment LS2011



Architectural Scale People Assortment A2012

Product descriptions on pages 17, 19-22, 24, 28-29, 35, 38 and 110.

## SHAKERS

- Shaker Merchandiser & Underbrush, Bushes and Flock Assortment ...UFC6011
  - Shaker Merchandiser & Ballast Assortment..... UB6005
  - Shaker Merchandiser & Turf Assortment.....UT6031
  - Shaker Merchandiser & Static Grass Flock Assortment .....UFL6012
  - Shaker Merchandiser.....BT1399
- Merchandiser holds 36 Canister Shakers. It is a counter, shelf, pegboard or slat wall display, and includes a two-color header. No assembly required.  
17" w x 9" d x 26 1/2" h
- Underbrush, Bushes and Flock Assortment ..... FC1630
  - Ballast Shaker Assortment .....B1398
  - Turf Shaker Assortment ..... T1396
  - Static Grass Flock Assortment ..... FL630

\*All Assortments above shown on Merchandiser BT1399



Product descriptions on pages 13 and 20-21.

UT6031 Merchandiser & Assortment

UFL6011 Merchandiser & Assortment

UB6005 Merchandiser & Assortment

## LEARNING KITS

- Learning Kit Assortment.....LK945



Product descriptions on page 5.

## READYGRASS® VINYL MAT

- ReadyGrass Vinyl Mat Merchandiser & Assortment.....URG6022
  - ReadyGrass Vinyl Mat Merchandiser..... RG5096
- Wire merchandiser displays the four sizes of grass mats: Large, Medium and Small Rolls and Project Sheets, each available in four realistic colors. Coordinating accessories include a Heat Tool, Mat Adhesive, plus Road Kit, Water Kit, Landscape Kit and Tree Kit.  
27" w x 16 1/4" d x 41 1/2" h
- ReadyGrass Vinyl Mat Add-On Assortment..... RG5101
  - ReadyGrass Vinyl Mat Assortment..... RG5102

Product descriptions on pages 28-29 and 41.



URG6022 Merchandiser & Assortment

## FOREST CANOPY™

- Forest Canopy Assortment.....F1655



Product descriptions on page 37.

## READY LANDFORMS™

- Ready Landforms Assortment ..... C1305



Product descriptions on pages 27 and 41.

**PREMIUM TREES**

- Premium Trees Merchandiser & Assortment**..... UTR6034
- Premium Trees Merchandiser** ..... TR1700
- Merchandiser includes a full-color header, reorder backing cards and 56 hooks. It displays various species of trees, ranging in size from 1 1/2" to 6", in colorful, clamshell packaging.
- 32" w x 28" h*
- Premium Trees Complete Assortment**..... TR1692
- Premium Trees Add-On Assortment** ..... TR1691



UTR6034 Merchandiser & Assortment

Product descriptions on pages 30-31 and 41.

**WOODLAND CLASSICS**

- Woodland Classics Merchandiser & Assortment**... UTR6035
- Woodland Classics Merchandiser** ..... TR3490
- This floor spinner merchandiser comes with a full-color header and reorder backing cards. It displays 45 selections of Woodland Classics trees ranging in height from 3/4" to 9", in colorful clamshell packaging.
- 25" w x 26" d x 78 1/2" h*
- Woodland Classics Trees Assortment** ..... TR3491



**NEW**

UTR6035 Merchandiser & Assortment

Product descriptions on pages 32-33 and 41.

**READY MADE REALISTIC TREES**

- Ready Made Realistic Trees Merchandiser & Assortment** ..... UTR6032
- Ready Made Realistic Trees Merchandiser** ..... TR1599
- Merchandiser includes a full-color header, reorder backing cards and 50 hooks. It displays 25 selections of deciduous and pine trees, ranging in size from 3/4" - 9", in colorful, clamshell packaging.
- 42" w x 62" h*
- Ready Made Realistic Trees Assortment** ... TR1590



UTR6032 Merchandiser & Assortment

Product descriptions on pages 34-35 and 41.

**READY MADE TREES VALUE PACK**

- Ready Made Trees Value Pack Merchandiser & Assortment**... UTR6033
- Ready Made Trees Value Pack Merchandiser** ..... TR1597
- Merchandiser includes a full-color header, reorder backing cards and 26 hooks. It displays thirteen different colorful, clamshell packages of pine and deciduous trees. Quantities vary from 12 - 38 trees per package in sizes ranging from 3/4" - 8".
- 32" w x 64" h*
- Ready Made Trees Value Pack Complete Assortment** ..... TR1593
- Ready Made Trees Value Pack Add-On Assortment**..... TR1592



UTR6033 Merchandiser & Assortment

Product descriptions on pages 36-37 and 41.

**CLUMP FOLIAGE/TREE KITS**

- Clump-Foliage/Tree Kit Merchandiser & Assortment** ..... UFC6010
- Clump-Foliage/Tree Kit Merchandiser** ..... FC998
- Vinyl merchandiser hangs on pegboard and displays six different Clump-Foliage colors, six different Realistic Tree Kits and Hob-e-Tac Adhesive.
- 41" w x 47" h*
- Clump-Foliage/Tree Kit Assortment** ..... FC907



UFC6010 Merchandiser & Assortment

Product descriptions on pages 19, 22 and 39.

## PRODUCT POPPER

**Product Popper** ..... A1799  
 Showcase the new N and HO scale Scenic Accents or AutoScenes next to your cash register on the high-quality plastic Product Popper. Products should be changed every two weeks with new releases.  
 6 1/2" w x 6 1/2" d x 19" h



## N SCALE SCENIC ACCENTS

- N Scale Scenic Accents Swinger Merchandiser & Assortment** ..... UA6003
- Grip and Glue Chute Merchandiser & Assortment** ..... UA6002
- N Scale Scenic Accents Swinger Merchandiser** ..... A2106  
 Feature your N scale Scenic Accents on pegboard with this space-saving Swinger Merchandiser display. Includes six Display Panels, Panel Pulls plus a Bracket that holds the Complete Assortment with room to grow. Free offsetting goods with combined purchase of Merchandiser and Assortment. The free goods pay for your Merchandiser!  
 21" w x 23" d x 10" h
- N Scale Swinger Add-On Panel** ..... A2109
- Grip and Glue Chute** ..... A2107  
 This optional Grip and Glue Chute hangs next to the N Scale Merchandiser and holds 16 Gentle Grips and dispenses 12 bottles of Scenic Accents Glue.
- Grip and Glue Assortment** ..... A2108
- Complete Assortment** ..... A2436
- Add-On Assortment** ..... A2435

Product descriptions on pages 41-51.



UA6003 Merchandiser & Assortment and UA6002 Merchandiser & Assortment

## HO SCALE SCENIC ACCENTS

- HO Scale Scenic Accent Merchandiser & Assortment** ..... UA6000
- HO Scale Scenic Accents Swinger Merchandiser** ..... A18044  
 Merchandiser includes nine Display Panels and two Brackets plus a separate dispenser for 12 bottles of Scenic Accents Glue and 16 Gentle Grips. This durable, compact merchandiser easily hangs on pegboard. Its unique ability to maximize inventory space makes it a sure bet, by incorporating swinging display panels with Panel Pulls for easy viewing of the HO scale Scenic Accents. The Swinger comes with a colorful 6" x 20" header. Free offsetting goods with combined purchase of Merchandiser and Assortment. The free goods pay for your Merchandiser!  
 48" w x 10" h x 33" d
- HO Scale Swinger Add-On Panel** ..... A1806
- HO Scale Swinger Add-On Panel and Bracket** ..... A18061
- Complete Assortment** ..... A1740
- Add-On Assortment** ..... A1739

Product descriptions on pages 41-51.



UA6000 Merchandiser & Assortment

## SCENIC ACCENTS ECONOMY PACKS

- Scenic Accents Economy Packs**  
 Assortments include one each of either N or HO scale Assorted Farm, Worker and Figure Sets. The colorful packaging hangs on pegboard. Customers save over 30%. **Limited supply.**
- HO Scale Scenic Accents Economy Pack Assortment** ..... A2050
- N Scale Scenic Accents Economy Pack Assortment** ..... A2060

Product descriptions on page 51.



Call for pricing and assortment information.

## O SCALE SCENIC ACCENTS

### O Scale Scenic Accents

**Complete Assortment** ..... A2915

Order this assortment of O scale Scenic Accents and receive a full-color header which measures 20" x 6".

29" w x 55" h

**O Scale Scenic Accents Complete Assortment**... A2917

**Add-On Assortment**..... A2914

**Add-On Assortment**..... A2916



Complete Assortment A2915

Product descriptions on pages 41-48.

## G SCALE SCENIC ACCENTS

### G Scale Scenic Accents

**Complete Assortment** ..... A2660

Order this assortment of G scale Scenic Accents and receive a full-color header, which measures 19" x 5 1/2".

35 1/2" w x 61" h



Complete Assortment A2660

Product descriptions on pages 41 and 52-55.

## N SCALE AUTOSCENES

### N Scale AutoScenes

**Complete Assortment** ..... AS5286

Eighteen different N scale scenes...finely sculpted and custom painted capturing the '40s and '50s eras.

22" w x 16" h

### N Scale AutoScenes

**Complete Assortment** ..... AS5288

**Add-On Assortment**..... AS5285

**Add-On Assortment**..... AS5287



Complete Assortment AS5286

Product descriptions on pages 41 and 58-60.

## HO SCALE AUTOSCENES

### HO Scale AutoScenes Complete

**Assortment** ..... AS5514

Thirty-four different HO scale scenes...finely sculpted and custom painted capturing the '40s and '50s eras. Order this assortment and receive a full-color header.

22" w x 45" h

**Add-On Assortment**..... AS5513



Complete Assortment AS5514

Product descriptions on pages 41 and 58-61.



## N SCALE BUILT-&READY LANDMARK STRUCTURES



### N Scale Built-&Ready Landmark Structures

**Complete Assortment** ..... BR4894

Six N scale preassembled, architecturally detailed buildings that are hand-painted and come in see-through, stackable packages with four-sided product visibility. Shipped in a separate protective box.



Complete Assortment BR4893

### N Scale Built-&Ready Landmark Structures

**Complete Assortment** ..... BR4893

Five N scale preassembled, architecturally detailed buildings that are hand-painted and come in see-through, stackable packages with four-sided product visibility. Shipped in a separate protective box.

Product descriptions on pages 41 and 65-67.

## HO SCALE BUILT-&READY LANDMARK STRUCTURES

**HO Scale Built-&Ready Landmark Structures Complete Assortment** ..... BR5010

Twelve HO scale preassembled, architecturally detailed buildings that are hand-painted and come in see-through, stackable packages with four-sided product visibility. Packages nest for easy stacking. Shipped in a separate protective box.

**HO Scale Built-&Ready Landmark Structures Complete Assortment** ..... BR5008

Eleven HO scale preassembled, architecturally detailed buildings that are hand-painted and come in see-through, stackable packages with four-sided product visibility. Packages nest for easy stacking. Shipped in a separate protective box.



Complete Assortment BR5008.



Product descriptions on pages 41 and 65-67..

## PRE-FAB LANDMARK STRUCTURES BUILDING KITS

**Pre-Fab Landmark Assortment** ..... PF5220

Assortment includes two each of four Pre-Fab Building Kits. Packaged in sturdy, brightly colored boxes. Box artwork provides four shelving options to make the most of your display space.



Complete Assortment PF5220

Product descriptions on pages 63-64.

## N SCALE BUILDING KITS

**N Scale Kit Assortment** ..... 50099B

Order this assortment of N scale Building Kits and receive a two-color sign, reorder tags and a Plan-O-Gram.

27" w x 28" h



Product descriptions on pages 70-73.

## N SCALE MODULAR SYSTEM

**N Scale Modular Assortment** ..... 60100

Order this assortment of N scale Modular Wall Sections and receive a two-color sign, reorder tags and a Plan-O-Gram.

24" w x 22" h



Product descriptions on page 74.

**N SCALE GOLD KITS**

**N Scale Gold Kit Assortment** ..... 60099A

Two each of four kits.



Product descriptions on pages 68-69

**HO SCALE GOLD KITS**

**HO Scale Gold Kit Assortment** ..... 40099E

Two each of seven kits.

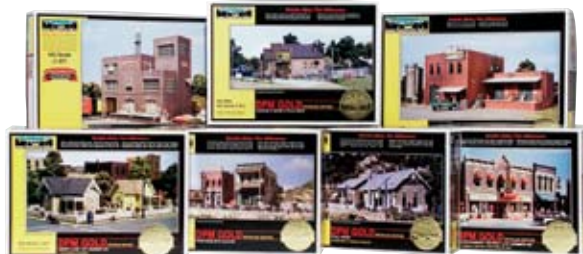

Product descriptions on pages 75-76

**HO SCALE BUILDING KITS**

**HO Scale Kit Assortment** ..... 10099

Order this assortment of HO scale Building Kits and receive a two-color sign, a set of four-color reorder cards and a Plan-O-Gram.



Product descriptions on pages 77-81 and 85

**HO SCALE MODULAR SYSTEM**

**HO Scale Designer Bulk Pack**

**Modular Wall Merchandiser** ..... 30199

Three-piece vinyl merchandiser can be displayed as shown, or arranged to fit your available space. This merchandiser displays Assortment 301-H.

**HO Scale Complete Designer Bulk Pack**

**Modular Assortment** ..... 301H

**HO Scale Partial Designer Bulk Pack**

**Modular Assortment** ..... 301J



Product descriptions on pages 83-86

**HO SCALE SELECT BUILDING KITS**

**Select Building Kit Assortment** ..... 10061

Two each of two kits.



Product descriptions on page 82.

Call for pricing and assortment information.

## O SCALE MODULAR SYSTEM

### O Scale Modular

**Assortment** ..... 90199  
 Order this O Scale Modular Assortment and receive a two-color sign, reorder tags and Plan-O-Gram. 32" w x 21" h



Product descriptions on pages 87-88.

## O SCALE BUILDING KITS

### O Scale Building Kit

**Assortment** ..... 80099  
 Two each of three kits.



Product descriptions on page 87.

## MINI-SCENE

### HO Scale Mini-Scene Merchandiser & Assortment.. UM6017

**HO Scale Mini-Scene Merchandiser** ..... M129  
 Counter or shelf display for the entire line of Mini-Scenes®. It includes a full-color header and a pewter patina finished Abandoned Log Cabin (M101) Built-Up displayed in a glass dome. The merchandiser holds twelve different Mini-Scenes, twelve-color Paint Sets, Pewter Patina Finish and glass Display Domes.  
 34" w x 14" d x 20" h

**Mini-Scene Assortment** ..... M120



Product descriptions on page 91.

UM6017 Merchandiser & Assortment

## SCENIC DETAILS

### HO Scale Scenic Details

**Merchandiser & Assortment** ..... UD6008

### HO Scale Scenic Details

**Merchandiser** ..... D299

Merchandiser displays 47 Scenic Details. This two-sided spinner sits on a counter or shelf. Includes a bright header.  
 16 1/2" w x 40" h

### Scenic Details

**Assortment** ..... D295



Product descriptions on pages 56-57, 62 and 89-90.

UD6008 Merchandiser & Assortment

## COMPLETE SCENES

### HO Scale Complete Scenes

**Assortment** ..... S5  
 Order this assortment of three different HO scale scenes! Each kit has a different size footprint.



### HO Scale Scene Kit

**Assortment** ..... TS156  
 Order this assortment of Trackside Scenes and Complete Scenes.



Product descriptions on pages 92-93.

## TRACKSIDE SCENES

### HO Scale Trackside Scenes

**Merchandiser and Assortment** ..... TS150  
 Cardboard merchandiser is a counter or shelf display that holds eight complete HO scale kits. Each kit contains over 70 pieces.  
 11" w x 12" h x 10 3/4" d



Product descriptions on page 92.

### DRY TRANSFER DECALS

**Dry Transfer Decals Merchandiser & Assortment**.....UDT6009  
**Dry Transfer Decals Merchandiser**.....DT595  
 Convenient counter or pegboard display that holds 40 different Dry Transfer Decals. It allows for immediate viewing and access. No assembly required.  
 23" w x 10" d x 8 1/2" h

**Dry Transfer Decals Assortment**.....DT594



UDT6009 Merchandiser & Assortment



Pegboard Display

Product descriptions on pages 100-102.

### MODEL GRAPHICS

**Model Graphics Merchandiser & Assortment**....UMG6018  
**Model Graphics Merchandiser**.....MG700  
 Displays 64 different styles of high-quality Model Graphics and holds six Dry Transfer Burnishers. Counter, shelf or pegboard spinner with a two-color header.  
 17" w x 34 1/2" h

**Model Graphics Assortment**.....MG795



Pegboard Spinner

Product descriptions on page 103.



UMG6018 Merchandiser & Assortment

### HOB-BITS

**Hob-Bits Merchandiser & Assortment**.....UH6013  
**Hob-Bits Merchandiser**.....H899  
 Counter or pegboard spinner. It includes a two-color header with a chart for determining the appropriate fastener. Miniature machine screws are available in four different styles and a variety of sizes. Hex nuts, washers, wrenches and taps are easily displayed.  
 12" w x 12" d x 24" h

**Hob-Bits Assortment**.....H800



Pegboard Spinner



UH6013 Merchandiser & Assortment

Product descriptions on page 104.

### HOB-E-LUBE

**Hob-E-Lube Merchandiser & Assortment**.....UHL6014  
**Hob-E-Lube Merchandiser**.....HL695  
 Counter, shelf or pegboard merchandiser, which holds seven different lubricants. Also included is product information, so your customer can choose the right lubricant.  
 24" w x 16" h

**Hob-E-Lube Assortment**.....HL690



UHL6014 Merchandiser & Assortment

Product descriptions on page 104.

### HOB-E-LUBE PREMIUM OILS

**Hob-E-Lube Premium Oils Assortment**.....HL691  
 Assortment includes a free 8" x 8" backing card and displays four different Premium Oils. These oils have a special 2 1/4-inch needle tip applicator.



Product descriptions on page 104.



## SCENE-A-RAMA

<b>Scene-A-Rama Merchandiser &amp; Assortment</b> .....	USP6023
<b>Scene-A-Rama Scene Setters Add-On Merchandiser &amp; Assortment</b> .....	USP6036
<b>Scene-A-Rama Merchandiser</b> .....	SP4095
Sits on the floor and displays over 37 different products, including Diorama Kits, Accents, Trees, ReadyGrass Sheets, Project Base & Backdrops, ShowBoxes, Project Adhesives, Project Accessories, Scene Setters and the Project Book. 42" w x 22" d x 74" h	
<b>Scene-A-Rama Scene Setters Add-On Merchandiser</b> .....	SP4094
Display four each of ten different Scene Setters with these two add-on side racks. They easily attach to your Scene-A-Rama merchandiser and swing to display facing front or to each side.	
<b>Scene-A-Rama Complete Assortment</b> .....	SP4100
<b>Project Pack Assortment</b> .....	SP4321
<b>Scene Setters Assortment</b> .....	SP4330



Scene Setters Assortment SP4330

**NEW**



Project Pack Assortment SP4321



USP6023 Merchandiser & Assortment

Product descriptions on pages 106-116.

## SCENE-A-RAMA BUILT UP

**Scene-A-Rama Dealer In-Store Built-Up** .....D7  
Staged built-up demonstrates four easy steps to a great diorama. Set it by the Scene-A-Rama products to promote sales. This is a dealer direct item.



**Native American In-Store Built-Up**.....D1  
This ISBU is the perfect example of a project that can be created using Scene-A-Rama. Set it next to your cash register, or the Scene-A-Rama Merchandiser, to draw attention and promote increased sales. This is a dealer direct item.

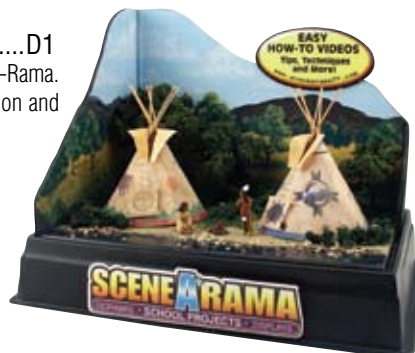

*Merchandisers & Asst.*

**PINECAR**

<b>PineCar Merchandiser &amp; Assortment</b> .....	UP6019
<b>PineCar Add-On Merchandiser &amp; Assortment</b> .....	UP6021
<b>PineCar Merchandiser &amp; Starter Assortment</b> .....	UP6020
<b>PineCar Merchandiser</b> .....	P3996
Displays 99 products on a space-saving floor spinner. It has a colorful header and can be converted to a wall mount. 31" w x 31" d x 86" h	
<b>Add-On Merchandiser</b> .....	P3997
Add 32 new PineCar products without using additional floor space. The four additional add-on sections easily attach to your existing floor or wall-mounted merchandiser.	
<b>Complete Assortment</b> .....	P3891
<b>Add-On Assortment</b> .....	P3890
<b>Starter Assortment</b> .....	P3892
<b>Mini Starter Assortment</b> .....	P3907

**NEW**



Pegboard Display

Product descriptions on pages 118-132.

UP6019 Merchandiser & Assortment

**SAILBOAT RACER**

<b>SailBoat Racer Merchandiser &amp; Assortment</b> .....	USR6030
<b>SailBoat Racer Merchandiser</b> .....	SR495
Shelf or wall unit that displays Assortment SR490. 24" w x 19" h	
<b>Assortment</b> .....	SR490



USR6030 Merchandiser & Assortment

Product descriptions on page 134.

Call for pricing and assortment information.

**A**

Adhesives..... 19, 29, 51  
 Architectural Model Landscape Ass't..... 137  
 Architectural Scale People Assortment..... 137  
 Assortments..... 136-144  
 AutoScenes..... 41, 58-61  
 Assortments..... 140  
 N Scale..... 58-60  
 HO Scale..... 58-61

**B**

Ballast..... 13  
 Shaker Assortment & Merchandiser..... 137  
 Blended Turf..... 20  
 Books..... 4  
 Build A Display For Collectible Houses..... 4, 99  
 Buildings..... 63-90, 95, 97  
 Building Sets..... 89, 95, 97  
 Built-&-Ready Landmark Structures 41, 63, 65-68  
 Assortments..... 141  
 N and HO Scale..... 65-68  
 Bushes..... 21

**C**

Canister Shaker..... 19  
 Canister Shaker Set..... 19  
 City & Industry Building Set..... 95  
 Clump-Foliage..... 22  
 Coal..... 13  
 Coarse Turf..... 20  
 Collectible House Display Kit..... 99  
 Complete Landscape Kit..... 98  
 Complete Scenes..... 93  
 Assortment..... 143  
 Corner Module Kit..... 10  
 Corner Module Kit Stand..... 11  
 Culverts..... 14

**D**

Dead Fall..... 25  
 Decals & Graphics..... 100-103  
 Design Preservation Models  
 Landmark Structures..... 63, 68-88  
 Assortments & Merchandisers..... 141-143  
 Building Kits HO Scale..... 77-82  
 Building Kits N Scale..... 70-73  
 Building Kits O Scale..... 87  
 Gold Kits HO Scale..... 75-76  
 Gold Kits N Scale..... 68-69  
 Modular System..... 74, 83-86, 87-88  
 Modular HO Scale..... 83-86  
 Modular N Scale..... 74  
 Modular O Scale..... 87-88  
 Select Building Kits..... 82  
 Dry Transfer Burnisher..... 100, 103  
 Dry Transfer Decals..... 100-102  
 Assortment & Merchandiser..... 144

**E**

Earth Colors Liquid Pigment..... 17  
 Earth Color Kit..... 17  
 Undercoat..... 17  
 E-Z Water..... 26

**F**

Fasteners & Lubricants..... 104  
 Field Grass..... 23  
 Figures & Accents..... 42-57  
 Fine-Leaf Foliage..... 38  
 Fine Turf..... 20  
 Flex Paste..... 9, 14  
 Flowering Foliage..... 25  
 Flowers..... 25  
 Foam Cutter Bow & Guide..... 8  
 Foam Knife..... 8  
 Foam Knife Blades..... 8  
 Foam Nails..... 8  
 Foam Pencils..... 8  
 Foam Putty..... 9  
 Foam Sheets..... 7  
 Foam Tack Glue..... 8  
 Foliage..... 24  
 Foliage Clusters..... 22  
 Forest Canopy..... 37  
 Assortment..... 137  
 Fruit..... 25

**G**

Gentle Grips..... 51  
 Glass Display Dome and Base..... 91  
 Grand Valley Layout Kit..... 94-95  
 Building Sets..... 89, 95, 97  
 Track Pack..... 95

**H**

Hob-Bits..... 104  
 Assortment & Merchandiser..... 144  
 Hob-E-Lube..... 104  
 Assortment & Merchandiser..... 144  
 Lubricants..... 104  
 Premium Oils..... 104  
 Hob-E-Tac Adhesive..... 19  
 Hot Wire Foam Cutters..... 8  
 Replacement Wire..... 8  
 Bow & Guide..... 8

**I**

Incline Sets and Starters..... 6-7  
 In-Store Built-Ups..... 145

**L**

Landmark Structures..... 63-88  
 Landscaping System..... 19-26  
 Assortments & Merchandiser..... 136  
 Latex Rubber..... 18  
 Layout Kits..... 94-99  
 Lead-Free Metal Tree Kits..... 39-40  
 Hardwood Forest Kit..... 40  
 Large Tree Kits..... 40  
 Pine Forest Kit..... 40  
 Small Tree Kits..... 39  
 Learning Kits..... 5  
 Assortment..... 137  
 Landscape..... 5  
 River/Waterfall..... 5  
 Road System..... 5  
 Rock Faces..... 5  
 Scenery Details..... 5  
 Trees..... 5  
 Lichen..... 23  
 Lightweight Hydrocal..... 16  
 Low Temp Foam Glue Gun..... 9  
 Low Temp Foam Glue Sticks..... 9

**M**

Mat Adhesive..... 29  
 Merchandisers..... 136-144  
 Mini-Scene..... 91  
 Assortment & Merchandiser..... 143  
 Paint Set..... 91  
 Model Graphics..... 103  
 Assortment & Merchandiser..... 144  
 Model Scenery Made Easy (DVD-VHS)..... 4  
 Mod-U-Rail System..... 10-11  
 Connector Plate Set..... 11  
 DVD..... 11  
 Module Kits..... 10  
 Module Kit Stands..... 11  
 Mold-A-Scene Plaster..... 14  
 Mountain Valley Scenery Kit..... 98

**P**

Paving Tape..... 9  
 Pewter Patina Finish..... 91  
 Plaster Cloth..... 7, 14  
 Poly Fiber..... 24  
 Pre-Fab Landmark Structures Building Kits. 63-64  
 Assortment..... 141  
 Premium Trees..... 30-31, 41  
 Assortment & Merchandiser..... 138  
 Product Popper..... 139  
 Profile Boards..... 7

**R**

Ready Landforms..... 27, 41  
 Assortment..... 137  
 Ready Made Realistic Trees..... 34-35, 41  
 Assortment & Merchandiser..... 138  
 Ready Made Trees Value Pack..... 36, 41  
 Assortment & Merchandiser..... 138  
 ReadyGrass Vinyl Mat..... 28-29, 41  
 Assortment & Merchandiser..... 137  
 Heat Tool..... 29  
 Landscape Kit..... 29  
 Mat Adhesive..... 29  
 Project Sheets..... 28  
 Road Kit..... 29  
 Tree Kit..... 29  
 Water Kit..... 29  
 Ready-To-Go Products..... 41  
 Realistic Tree Kits..... 39  
 Realistic Water..... 26  
 Retaining Walls..... 15  
 Risers..... 6-7  
 River Pass Layout Kit..... 96-97  
 Building Kits..... 89, 95, 97  
 Scenery Kit..... 96, 99  
 Track Pack..... 96  
 Road System..... 9  
 Paving Tape..... 9  
 Smooth-It..... 9  
 Top Coat (Asphalt)..... 9  
 Top Coat (Concrete)..... 9  
 Rock Molds..... 16  
 Rocky Ridges..... 27

**S**

Scale Chart..... 51  
 Scenery Clinic..... 136  
 Scenic Accents..... 41-55  
 Asst. & Merchandisers..... 139-140  
 Economy Packs..... 51  
 G Scale..... 52-55  
 N, HO, O Scale..... 42-51  
 Glue..... 51  
 Gentle Grips..... 51  
 Scenic Cement..... 19  
 Scenic Details..... 56-57, 62, 89-90  
 Assortment & Merchandiser..... 143  
 Scenic Glue..... 19  
 Scenic Ridge Layout Kit..... 94-95  
 Building Set..... 89, 95  
 Track Pack..... 95  
 Scenic Sprayer..... 19  
 Select Building Kits..... 82  
 Shaker Merchandiser..... 137  
 Smooth-It..... 9  
 Soft Flake Snow..... 25  
 Square Module Kit Stand..... 11  
 Static Grass Flock..... 21  
 Shaker Assortment..... 137  
 Straight Module Kit Stand..... 11  
 Straight Module Kit..... 10

Stumps..... 25  
 SubTerrain System..... 6-9  
 Assortments & Merchandisers..... 136  
 SubTerrain: Build A Layout Fast and Easy (DVD, VHS)..... 4  
 SubTerrain Manual..... 4  
 SubTerrain Scenery Kit..... 98

**T**

Talus (Rock Debris)..... 18  
 Terrain & Landscape..... 14-29  
 Terrain System..... 14-18  
 Assortments & Merchandiser..... 136  
 The Clinic..... 4  
 The Scenery Kit..... 98  
 The Scenery Manual..... 4  
 Top Coat (Asphalt/Concrete)..... 9  
 Town and Factory Building Set..... 95  
 Track-Bed..... 12  
 Assortments & Merchandiser..... 136  
 Rolls..... 12  
 Sheets..... 12  
 Strips..... 12  
 Strips (Bulk)..... 12  
 Super Sheets..... 12  
 Trackside Scenes..... 92  
 Assortment..... 143  
 Tree Armatures..... 38  
 Tunnels..... 27  
 Tunnel Liner Form..... 18  
 Tunnel Portals..... 15  
 Turf Shaker Assortment & Merchandiser..... 137

**U**

Underbrush..... 21  
 Underbrush, Bushes & Flock Assortment and Merchandiser..... 137

**V**

Vehicles..... 41, 58-62  
 Videos..... 4, 99

**W**

Water Effects..... 26  
 Woodland Classics..... 32-33  
 Assortments & Merchandiser..... 138

**SCENARAMA®**

**A**

Accents..... 110-111  
 Accessories..... 111-114  
 Adhesives..... 114  
 Assortments & Merchandiser..... 145

**B**

Building & Structure Kit..... 112

**C**

Casting Plaster..... 114  
 Classroom Packs..... 116  
 Cell Structure..... 116  
 Creative Mask..... 116  
 Erupting Volcano..... 116  
 Teepee Village..... 116

**D**

Desert Plants..... 111  
 Diorama Kits..... 108-109  
 Basic Diorama Kit..... 108  
 Desert Oasis Diorama Kit..... 108  
 Mountain Diorama Kit..... 109  
 Water Diorama Kit..... 109

**F**

Foliages & Grasses..... 110

**H**

Horizon & Detail Kit..... 112

**I**

In-Store Built-Ups..... 145

**P**

Plaster Cloth..... 113  
 Project Base & Backdrops..... 107  
 Project Book..... 106  
 Project Glue..... 114  
 Project Packs..... 115  
 Cell Structure..... 115  
 Creative Mask & More..... 115  
 Erupting Volcano..... 115  
 Native American Village..... 115

**R**

ReadyGrass Sheets..... 113  
 Ripplin' Water Kit..... 110  
 Rock Making Kit..... 110

**S**

Scene Setters..... 114  
 Assortment..... 145  
 Sculpting Kit..... 111  
 ShowBox..... 106  
 Sticky Bond..... 114

**T**

Trees..... 113

**W**

Winter Effects..... 111

**A**

Accessories..... 130-131  
 Adhesives..... 130  
 Adjustable Stick-On Weights..... 132  
 Assortments & Merchandisers..... 146  
 Axles & Polishing Kit..... 131  
 Aerodynamic Pre-Cut Designs..... 119

**B**

Block..... 118  
 Body Putty..... 130  
 Body Skin Custom Transfers..... 121  
 Building PineCar Racers (DVD, VHS)..... 118  
 Body Builder Kit..... 129

**C**

Canopy & Cockpit Sets..... 129  
 Certificates, Ribbons and Trophies..... 133  
 Chassis Weights..... 132  
 Cockpits and Drivers..... 129  
 COG System..... 131  
 Combo Weights..... 132  
 Complete Paint System..... 122  
 Custom Finishing Kits..... 122  
 Custom Parts..... 128  
 Custom Parts With Decals..... 128

**D**

Deluxe Car Kits..... 119  
 Designer Kits..... 120  
 Designer Kits With Wedge..... 120  
 Designer Stick-On Weights..... 132  
 Diamond Finishing Kit..... 130  
 Dry Transfer Decals..... 123-125  
 Dry White Teflon With Cling..... 131

**F**

5 Axles..... 130  
 Featherweight Customizing Kit..... 131  
 Formula Glue..... 130

**H**

High-Gloss Dry Transfer Decals..... 125  
 Hob-E-Lube Dry Graphite Lubricant..... 131  
 How-To Book..... 118

**M**

Micro-Polishing System..... 130

**P**

Performance & Conformity System..... 129  
 PineCar Race Package..... 133  
 PineCar Racer Basic Kit..... 118  
 PineCar Racer Bodies and Kits..... 118-120  
 PineCar Racer Premium Kits..... 120  
 PineCar Racer Wedge Kit..... 118  
 Pre-Cut Designs..... 119  
 Program Guide..... 118

**R**

Racer Display Stand..... 130  
 Racer Shaping Tools..... 129  
 Racing Wheels..... 130  
 Round Weights..... 132

**S**

SailBoat Racer Kit..... 134  
 SailBoat Racer Decals..... 134  
 Sanding Pads..... 130  
 Sanding Sealer & Wax..... 130  
 Sandpaper Assortment..... 130  
 Show Wheels..... 130  
 Speed Kit..... 131  
 Speed Racer Kit..... 119  
 Stick-On Decals..... 126-127  
 Stick-On Details..... 127  
 Super Glue..... 130

**T**

Tapered, Strip and Bar Weights..... 132  
 Tools & Adhesives..... 129-130  
 Tungsten Incremental Weights..... 132

**W**

Wedge..... 118  
 Weights..... 132  
 Wheel Alignment Tool..... 131  
 Wheel Turning Mandrel..... 131  
 Windshield Kit..... 129

**X**

XLR8 Ultra Graphite..... 131

Models and photos on pages 5, 9, 13, 15, 18, 19, 25, 37 with modifications by Pelle K. Seeborg.  
 Models and photos on pages 4, 23 and 34 by W. Allen McClelland.  
 Model and photo on page 57 by Paul "Shamus" Templar.



**WOODLAND SCENICS®**

P.O. Box 98 • Linn Creek, MO 65052  
Phone 573-346-5555 • Fax 573-346-3768  
www.woodlandscenics.com

FIRST CLASS  
U.S. POSTAGE  
**PAID**  
Permit #01  
Linn Creek, MO  
65052

**XLITWSCATALOG • R100**

©2009 OCO \$8.00



7 24771 00100 3