

PECO

Catalogue

Model Railway Products and Publications

9957

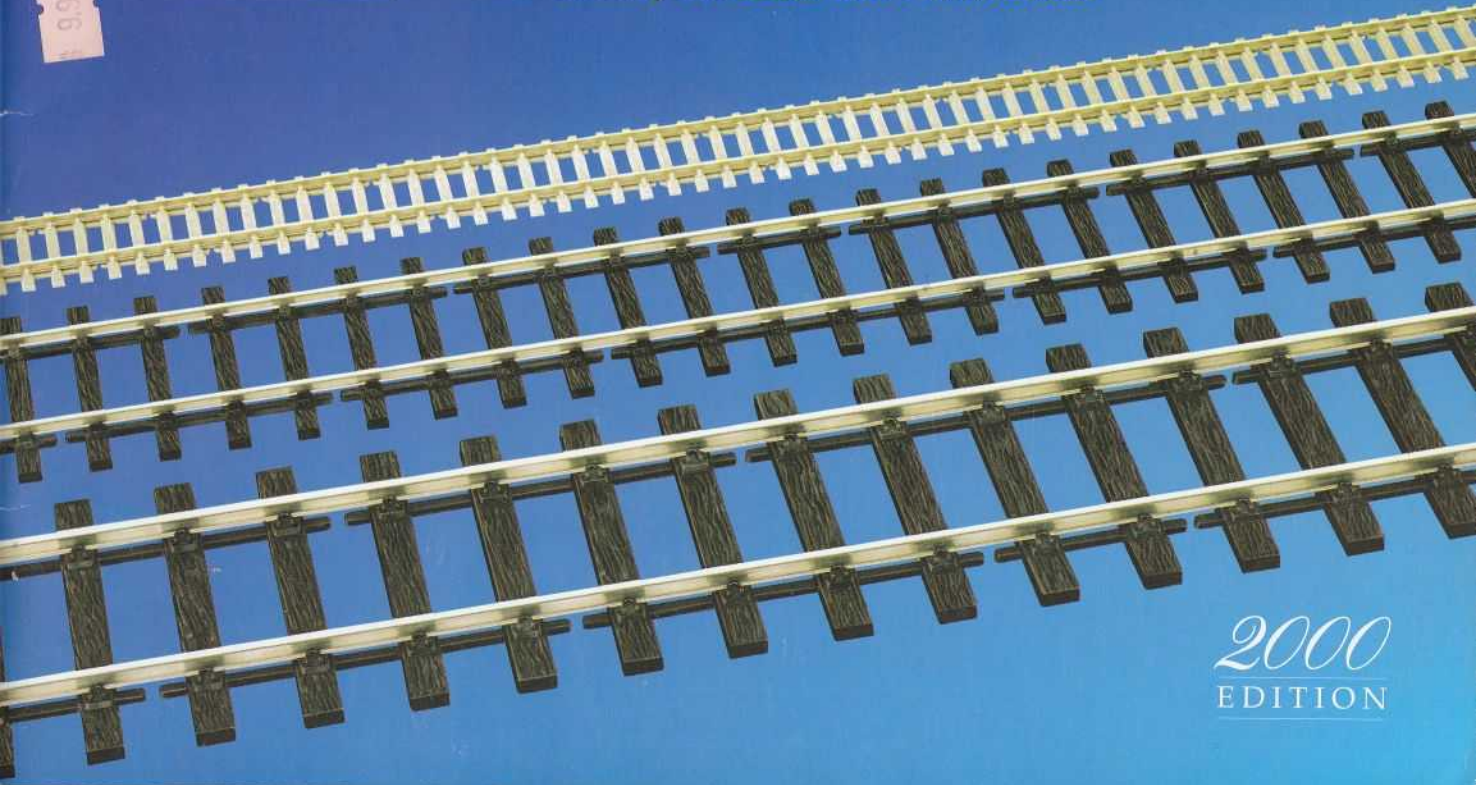

2000
EDITION

THE HOME OF PECO <i>A place for inspiration and fun</i>	2	H0m Streamline	45
RAILWAY MODELLING TODAY <i>Historic and Modern</i>	3	O-16.5 Streamline	46
MAKING A START <i>Baseboard Construction, Insulfrog or Electrofrog – which?</i>	4	SM-32 Streamline	47
PECO TECHNICAL ADVICE BUREAU <i>Free problem solving service</i>	4	G-45 Setrack and Streamline	48
PECO PUBLICATIONS		PECO LECTRICS <i>Turnout Motors, Switches, Probe & Studs, Bulbs etc.</i>	50
Railway Modeller and Continental Modeller monthly Magazines	5	STANDARD GAUGE WAGONS <i>Introduction</i>	53
‘Shows You How’ Booklets and Planbooks	6	N Quality Line Wagons, <i>Ready-to-Run</i>	54
Books – Model and Prototype	7	N Wagon Kits and Accessories	58
Videos – Railway Modeller ‘Shows You How’ series	8	N Rolling Stock Accessories	59
THE PROTOTYPE GAUGE <i>an explanation of the terminology</i>	9	OO Wonderful Wagon Kits and Accessories	61
THE MODEL GAUGE <i>Standard and Narrow gauge sizes</i>	10	O Wonderful Wagon Kits and Accessories	64
STANDARD GAUGE TRACK <i>Introduction</i>	12	NARROW GAUGE WAGONS & ROLLING STOCK <i>Introduction</i>	66
Z Streamline	13	N-6.5 Locomotive Body and Wagon Kits	67
N Setrack	14	OO-9 Locomotive Body Kits	67
N Streamline Universal	16	O-16.5 Locomotive Body Kits and Chassis	68
N Streamline Universal Fine	19	O-16.5 Rolling Stock Kits	69
OO/HO Setrack	22	LINESIDE & SCENIC <i>Introduction</i>	70
OO/HO Streamline Universal	27	Z Lineside Kits	71
OO/HO Streamline Fine	33	N Lineside Kits and Accessories	71
O Streamline Flat Bottom	36	OO/HO Lineside Kits and Accessories	75
O Streamline Bullhead	37	O Lineside Kits and Accessories	81
1 gauge Streamline	40	Scenic Materials <i>for all gauges</i>	83
INDIVIDUAL TRACK COMPONENTS <i>Standard, Broad & Narrow Gauge</i>	41	‘Manyways’ Scenic Backgrounds	84
NARROW GAUGE TRACK <i>Introduction</i>	44	CARD KITS	87
N-6.5 Streamline	44	OO/HO Coach Interiors,	87
OO-9/HOe Streamline	44	OO/HO Two-Arch Bridge	87

New products illustrated are not necessarily available at the time of going to press. See the current Peco price list (supplied free with this catalogue) for availability of items. Peco reserves the right to alter or delete products shown in this catalogue. All dimensions and quantities given are approximate and intended only as a guide.

JUNE 2000 This catalogue cancels all previous editions.

© PRITCHARD PATENT PRODUCT CO LTD

BEER, SEATON, DEVON, EX12 3NA, ENGLAND

Established 1946

☎ TELEPHONE 01297 21542

FAX 01297 20229



Tracks, Trains, Gardens and Games

Peco with its early products commenced trading in 1946 from a small two room cottage in the village of Branscombe, just 3 miles west of the present home in Beer. Business in those early post war years was brisk making wagon and coach wheels, Insulaxles, "True to Type" track parts, the famous Simplex Auto Coupler and a host of other accessories for the eager model railway enthusiast.

As the company developed, an opportunity arose in 1951 to purchase the Railway Modeller magazine and after much hard work and commitment it soon became the market leader in its field. Despite considerable competition Railway Modeller

remains in the number one position offering the best possible selection of articles and the most comprehensive assortment of advertisements to the reader every month.

The Continental Modeller magazine first went onto the newsagent shelves with the Nurnberg report issue of 1979. Over the last 20 years this magazine has become well established as the only journal covering model railway subjects from all countries of the world and written in the English language. Like its sister magazine, Continental Modeller is a most valuable source of information and a good read in general for all those enthusiasts

who enjoy learning about railways from overseas.

This special Millennium edition of the Peco catalogue illustrates in some detail the present range of products and publications which has made Peco world famous these last 50 and more years.

The Peco premises as illustrated above have been our home since November 1973 and during the last 26 years there have been many changes, further buildings have been constructed, extra land has been purchased and most importantly a tourist attraction has developed with a strong Railway theme. In fact Pecorama opened its doors to the public with a permanent

as well as an outdoor SM32 railway generally operated by live steam locomotives during certain times of the day at high season only.

Pecorama also offers the visitor many other attractions, in particular the famous BHLR 7 1/4" narrow gauge passenger carrying railway. A train journey from Much Natter Station will take you for a mile or so ride through flower filled gardens with breath taking views, something no visitor should miss. There is crazy golf, Feathers aviary, children's activity areas, a fitness trail in Wildway Park and special entertainment for children at the Top Spot open air theatre during the summer time.

Refreshments have not been forgotten, a wide selection of

hot and cold meals or snacks are available from the Garden Room restaurant. Then there is Orion, the full size genuine Pullman Car now preserved and located at Beer Victoria Station and here you can enjoy a Devonshire cream tea at any time of the day. All of this makes a visit to Pecorama a real pleasure and very memorable.

Before your visit it is essential that you obtain the latest free colour brochure which will give all the up to date details of facilities available including dates for entertainment and special occasions, opening times and admission charges. PLEASE remember that we are always closed Saturday afternoons.

We look forward to giving you a warm welcome on the occasion of your visit.

LEFT: Peco Head offices with entrance to the model exhibition on the left and the "Orion" Pullman car on right.

model railway exhibition during the summer of 1974 and the Beer Heights Light Railway ran its first train a year later.

The indoor exhibition is still the most important part of Pecorama since it is here where we try and give countless enthusiasts many ideas, including a suitable home for the railway, what gauges can be modelled, scenic possibilities and much more in the way of general information in the hope of inspiring for the future. There are exhibits ranging from Z, the smallest at 6.5mm gauge to the large G scale at 45mm narrow gauge. Models depict many different scenes - English style, mainland Europe and American



ABOVE: To find Pecorama - simply follow the brown tourist road signs.

PLANNING THE PERMANENT WAY

The trackwork is the focal point on which every model railway depends. It is therefore of the utmost importance that it is planned in a railway-like manner conforming to prototype practice and that the permanent way provides for perfect operation at all times.

By using the modern assembled flexible or unit track success is assured, and the fascination of actually being in charge and responsible for laying the track and watching it grow, is one of the most interesting facets of railway modelling.

Peco Streamline and Peco Setrack are the longer looking tracks – they look longer than they really are and this is due to the clever design of sleeper sizing and spacing. Flexible track is particularly useful for it is possible to take advantage of large transition or gradual curves which add extra realism to your layout.

Whatever plan and scale/gauge combination you may choose, remember that the operation of your layout can only ever be as good as the permanent way, so insist on the best – Peco Streamline and Peco Setrack.

BASEBOARD CONSTRUCTION

This is the very foundation of the whole model – the structure on which everything else

depends. It cannot be replaced without destroying hours of patiently executed work, so do not be tempted to skimp on its construction, even if the temptation is to hurry in order to get the trains running.

Make sure the baseboard, whether permanent or portable, is correct and well built – it is a false economy to make-do and quite wrong to imagine that imperfections in the surface will be smoothed out by the track.

Undoubtedly the most suitable material for the surface is 9.5mm ($\frac{3}{8}$ in) thick Sundekal™ fibre board. This cuts readily, reduces noise and accepts track fixing pins easily yet firmly. It must however be given an adequate wooden framework support.

Construct a frame from 50mm x 25mm (2in x 1in) prepared timber on edge, arranged with cross bearers to form squares not larger than 300mm (12in), but where, for example, the baseboard is only 450mm (18in) wide, still include the centre bearer with cross members at 300mm (12in) intervals.

The baseboard is best made in sections approximately 1200mm (4ft) long by the width required. This allows for portability (in the event of moving house) and the sections can be joined by using brass back flap hinges with the pins replaced by a wire handle.

Make sure that the framework is well constructed with glued and screwed joints and that the surface is quite level before pinning and gluing on the Sundekal™ board. Edges can be finished off with strips of hardboard or thin battens.

We cannot over emphasise the

importance of a soundly constructed baseboard. The Peco booklet 'Building Baseboards' (see page 6) is highly recommended, especially if you are a newcomer to the hobby.

INSULFROG OR ELECTROFROG – WHICH TO CHOOSE

The Peco Streamline Insulfrog electrical system is extremely simple, making it particularly suitable for the beginner or less experienced modeller. That said however, Insulfrogs are very popular among experienced enthusiasts as well.

Wiring instructions are almost unnecessary and, provided locomotives are fitted with sufficient current collectors, and the wheels have correct back to back dimensions perfect operation will be achieved.

INSULFROG (Insulated Frog)
Insulfrog turnouts incorporate the minimum dead section due to the tapered frog rail

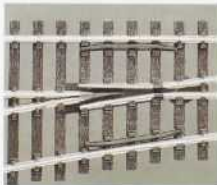

Peco Insulfrog

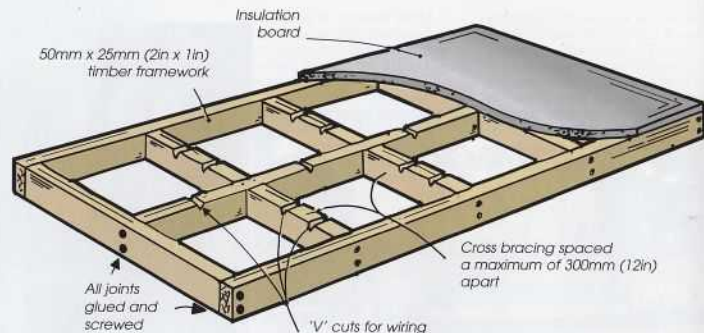

design (see illustration).

Each Peco Insulfrog turnout is 'switched' so that only the track for which the blades are set is electrically alive*.

*Except OO and N single and double slips, and G-45 R/H & L/H turnouts, see pages 20, 29, and 49.

ELECTROFROG (Live Frog)
The Peco Streamline Electrofrog system provides maximum

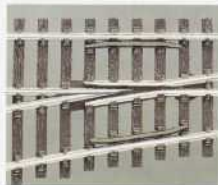

Peco Electrofrog

continuous electrical pick-up (see illustration) assuring perfect smooth running even at very slow speeds – provided of course, that current collectors and wheels are always kept clean.

A layout using Electrofrog turnouts is slightly more complicated to wire and therefore often suits the more experienced modeller. However, once the basic principle is learnt – i.e. 'current must always be fed to the toe end of each live frog turnout', the rest is not so very difficult. Like Insulfrog turnouts, all Electrofrog types are 'switched' or self isolating, so that the track for which the blades are set is the only road electrically alive.

All Peco Streamline turnouts (Electrofrog and Insulfrog) are supplied complete with a comprehensive illustrated Instructional.

ADVICE BUREAU

Railway modelling can be as simple or as complex as you wish to make it, one of the reasons why people from all walks of life find it so absorbing. Problems can however arise, but Peco is always ready to help you.

For well over 50 years the Peco Technical Advice Bureau has been helping to answer these difficult questions when problems arise, whether they are to do with our own products or constructional details with your model railway in general. The service in the main is free of charge but we do request that all enquiries be accompanied with a stamped addressed envelope.

Address your letters to:
Peco Technical Advice Bureau,
Beer, Seaton, Devon EX12 3NA,
England.
Telephone: 01297 21542
Fax: 01297 20229

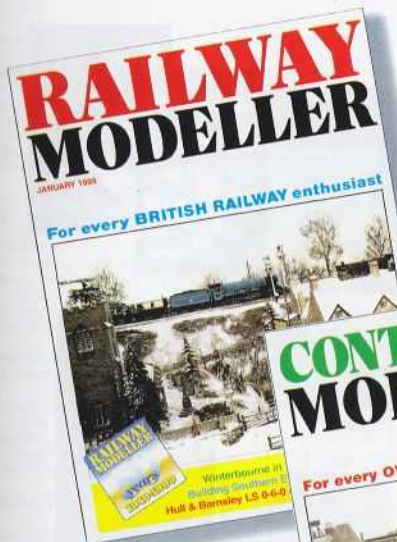

CONTINENTAL MODELLER

Incorporating INTERNATIONAL MODEL RAIL

For every OVERSEAS RAILWAY enthusiast



ESSENTIAL READING

Whether you are just a beginner having fun with your first train set, or an experienced modeller of many years' standing, you will need a number of books on various aspects of railway modelling and the prototype, plus the two leading magazines - Railway Modeller and Continental Modeller.

Peco Publications are essential reading for every railway modeller both before you begin and during your modelling activities. They will inspire and help you obtain maximum enjoyment from this fascinating hobby. The modelling books, booklets and magazines 'show you how' to build and operate your layout, whilst the publications about the prototype are invaluable sources of reference.

Finally, do not forget to obtain a copy of the PIP Catalogue of Model Railway Products which contains items complementary to the Peco range shown in this catalogue.

RAILWAY MODELLER

For every BRITISH RAILWAY enthusiast PB-100
The first name to remember - every month, Railway Modeller is Britain's most popular railway modelling magazine by far the largest circulation.

Recognised as the 'live wire' of model railway magazines, the Railway Modeller really 'shows you how' and keeps you up-to-date with all the latest news and topics in the fascinating world of railway modelling. Railway Modeller editorial concentrates entirely on the British scene and every month includes lavishly illustrated articles by experienced enthusiasts and examples of other modellers' layouts which will help you to get still more interest from your own line. These layouts are fully featured with lots of colour photographs. Also included every month is 'Latest Reviews' which contains up-to-the-minute reports of the very latest products.

CONTINENTAL MODELLER

Incorporating INTERNATIONAL MODEL RAIL
For every OVERSEAS RAILWAY enthusiast PB-101

The second name to remember - Continental Modeller, the companion magazine to Railway Modeller, concentrates every month entirely on overseas railways for the enthusiast who enjoys railways 'world-wide'. Continental Modeller knows no boundaries, whether you enjoy European, American, Australasian, African or Asian railways you will find plenty to interest you.

The contents are similar in style to Railway Modeller with 'shows you how' articles, lavishly illustrated layouts, plans and news of all the latest foreign railway models available in Britain.



RAILWAY MODELLER 'SHOWS YOU HOW' BOOKLETS

A series of useful yet inexpensive booklets that 'show you how' and provide much useful information, each on a particular aspect of the hobby.

SERIES 2

- 2 Building Baseboards
- 3 Laying the Track
- 4 Model Railway Terminology
- 6 Making a Start (OO/HO)
- 7 Making a Start in N
- 8 Building a OO Garden Layout
- 9 Wiring the Layout
- 10 Curing TV Interference
- 11 An introduction to Narrow Gauge

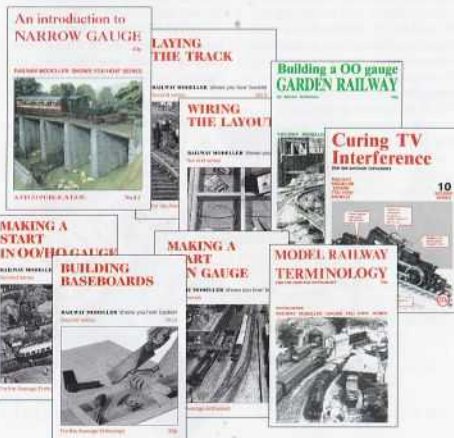

PLANBOOKS

SETRACK PLANBOOKS

These comprehensive planbooks give full instructions for the Setrack systems along with many detailed plans of both simple and complex layouts.

N gauge Setrack Planbook IN-1
OO/HO gauge Setrack Planbook STP-00

The Railway Modeller Book of TRACK PLANS for various locations PB-66
 A set of layout plans by the well known modeller and author Cyril Freezer, based on previously published designs, but re-drawn in line with modern ideas and trends. Suitable for all gauges.

The Railway Modeller Book of 60 PLANS for small locations PB-3

Sixty well tried, space saving layout plans by Cyril Freezer. Suitable for all gauges.

The Railway Modeller Book of N GAUGE TRACK PLANS PB-4

This, the latest track plan book by Cyril Freezer is specifically designed for N gauge layouts.

ERICPLANS

(Combined Edition) PB-40
 A useful collection of detailed drawings of GWR and LMS buildings, bridges and many other lineside items.

DOWNESPLANS

Two popular books for modellers who like to construct buildings from scratch to add originality to their layouts.

1 Railway Buildings PB-51
2 More Country Buildings PB-52

ORION AND THE GOLDEN ARROW PB-62

An illustrated description of the famous British boat train, together with the history and development of its luxury Pullman Cars.

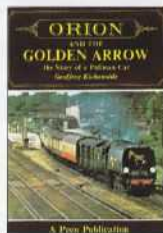
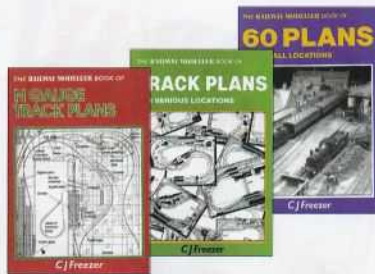
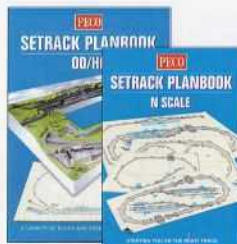

PPP CATALOGUE

An essential companion to this Peco Catalogue. The PPP Catalogue covers a vast range of model railway products and publications by other leading manufacturers which are complementary to the Peco range. Distributed by Peco, all the products shown in the catalogue should be available from your local Peco Stockist.

Together, these two catalogues provide valuable reference for the majority of your model railway requirements.



The Modeller Book of NARROW GAUGE PB-64
 Edited by the late David Lloyd. This is a compendium of some of the best contemporary narrow gauge modelling, together with prototype inspiration portrayed in both mono-chrome and colour.

ONE MAN'S RAILWAYS PB-65
 Ken Payne needs no introduction to regular Railway Modeller readers. After the success of his EM gauge 'Tyling Branch' Ken changed to O gauge in the garden. The book describes his layouts with track plans and photographs.

FAMOUS LAYOUTS
 A Railway Modeller Special PB-70
 Reprints of favourite layouts from past issues of the Railway Modeller. Includes: Berrow, Buckingham, Charford, Craig & Mertonford and Wallsea.

A HOME FOR YOUR RAILWAY PB-22
 How to find a place for a model railway within the confines of the average household. This book demonstrates a wide variety of options.

MODELLING THE IRISH NARROW GAUGE PB-69
 A compilation of David Lloyd's articles, published between 1964 and his untimely death in 1988. Centred around his well-known 4mm scale 'Augher Valley' model railway, the book contains descriptions, photographs and scale drawings of the extremely varied selection of locomotives

and rolling stock which ran on the 3' gauge railways of the Emerald Isle, which continue to fascinate enthusiasts to this day.

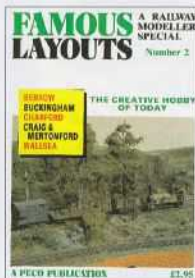
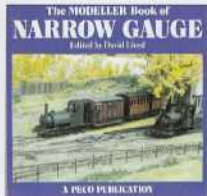
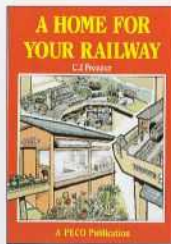
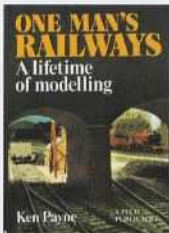
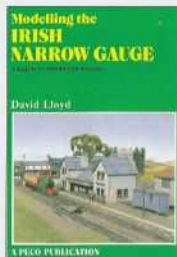

HARDBACK BOOKS

RAILS IN THE FELS PH-205
 A detailed survey by David Jenkinson of the Settle and Carlisle route of the Midland Railway. The author, a teacher and railway modeller covers the building of the line, the daunting topography of the area and the extraordinary engineering achievements required to carry the line through one of the most impressive landscapes in Great Britain. Fully illustrated with photographs, contour maps, scale drawings and track plans, the whole book has been designed with the railway modeller in mind.

NARROW GAUGE ADVENTURE PH-20
 The story of a pioneer 4mm scale narrow gauge model railway. P D Hancock kept readers of the Railway Modeller both inspired and amused throughout the 1950's and 60's, with his saga of the 'Craig and Mertonford'. Over the years there were several versions of the railway and their complete history is recounted in this book which features the same informative and entertaining style which made the original articles so appealing. Contains many of the author's fine photographs.

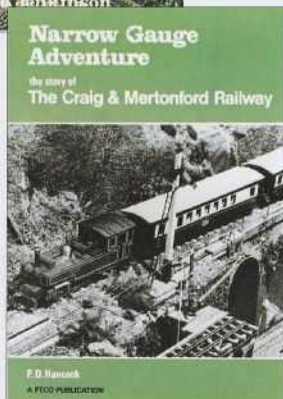
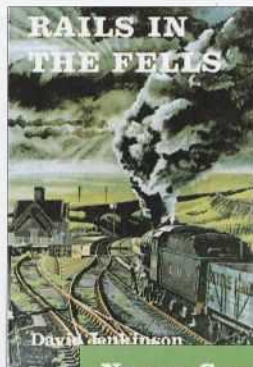

RAILWAY MODELLER 'SHOWS YOU HOW' VIDEOS

Designed to be both informative and fun to watch, these Shows You How videos are produced by Renaissance Vision in conjunction with Peco and Railway Modeller.

Packed with practical advice and useful tips from the experts, they provide easy-to-follow step-by-step guides and inspiration.

STEAMING THE BEER HEIGHTS LIGHT RAILWAY

If you have always wanted to know how to drive a steam locomotive, then why not let your ambition become a reality. The latest Peco Video will explain to you in every detail how an engine works and gives you the basic information on driving techniques. The friendly 1/3 size locomotives as found on the BHLR are the ideal means for teaching, not over daunting in size or for that matter not too small and have been used to illustrate the technical details. The video also includes some comparisons with the full size A MUST for all Budding Train Drivers.

Vol. 1 CREATING A MODEL RAILWAY

VID-1

The first in the Shows You How series of videos is designed to get you started and features everything from planning, baseboards, track laying, right through to scenery and finishing touches.

It uses practical demonstrations to explain well-proven techniques and sequences filmed on working layouts large and small to inspire you. It won't be long before you are creating a model railway of your own.

Layouts featured include many from the Pecorama Exhibition plus Bob Tivendale's Ashley Bidge and Weal Louise.

Vol. 2 CREATING CLASSIC LAYOUTS MOVING MOUNTAINS

VID-2

Europ is a flight of the imagination, an HO layout on a busy station at the crossroads of the European network. A place where trains of many countries come together.

The Charmes layout is the embodiment in N gauge of a modeller's philosophy which we are invited to share through his approach to research, design and modular techniques.

Jura-Simplon in HO is based on a prototype on the French/Swiss border. A large layout graced by the magnificent Jura mountains, regularly traversed by TGVs, the Orient Express and a host of other trains.

Vol. 3 CREATING CLASSIC LAYOUTS PROTOTYPES PORTRAYED

VID 3

Henry Holdsworth's 16mm scale Lyndridge is probably the finest indoor model of the Lynton and Barnstaple Railway ever produced. The large hand-built locomotives and stock trundle through a setting that vividly recreates the prototype.

Manchester Model Railway Society's Chee Tor exploits the potential of N by representing a main line in the Peak District. Locomotives and rolling stock are dwarfed as they pass through a spectacular landscape of gorges, valleys and hills.

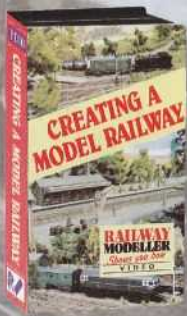
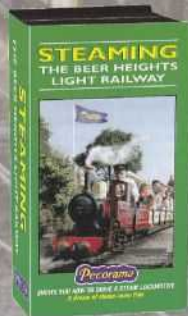

THE PROTOTYPE GAUGE



Standard Gauge – Setrack and Streamline
Narrow Gauge – Streamline
Broad Gauge and others – Individulay*

***Individulay** is a range of separate components which enable trackage to be made in any gauge. Broad, Standard or Narrow, in the popular scales.

It is also particularly useful for making special point formations. See pages 41, 42 and 43.

LEFT: Shrewsbury station from the Severn Bridge Junction box.

Photo by John Macdougall.

BELOW: At Blaenau Ffestiniog, North Wales, the standard gauge (4ft 8½in) tracks and narrow gauge tracks (1ft 11½in) of the Ffestiniog Railway meet.
Photo by John Macdougall.

As the British loading gauge is smaller than most others, to obtain a similar size-for-size, the scale is increased – eg. British N to 2½/16mm per foot, OO to 4mm and O to 7mm while the gauge remains common worldwide.

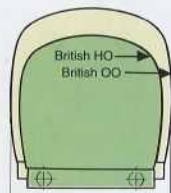

STANDARD GAUGE



STANDARD GAUGE

The gauge is the distance between the inside face of one rail to the other and is known by the following terminology:

STANDARD GAUGE

Originated by British pioneers and is defined by a gauge of 4ft 8½in which has become universal throughout the world. Loading gauge on the other hand – i.e. the width and height of vehicles varies from one country to another.

BROAD GAUGE

Any gauge that is wider than standard is defined as Broad. Originally the Great Western was built to a gauge of 7ft 0¼in but proved unsuccessful mainly because it was not practical to interchange traffic from the other lines and accordingly the whole system was re-laid to standard gauge. Other examples however still exist. Russian railways use a gauge of 5ft, the Irish railways use 5ft 3in, whilst Spain and Portugal both use 5ft 6in.

NARROW GAUGE

This defines any gauge that is narrower than standard, and again, the sizes vary considerably.

Possibly the best known lines are the 'Great Little Trains of Wales' which have examples of 12¼in (Fairbourne Railway), 15in and the most popular – 1ft 11½in (Ffestiniog). The Talyllyn is 2ft 3in and there are even wider examples that are more common overseas.

This Catalogue is therefore divided into prototype gauge sections and sections common to all scales.



FULL SIZE
STANDARD GAUGE
All dimensions in
millimetres

Gauge 1

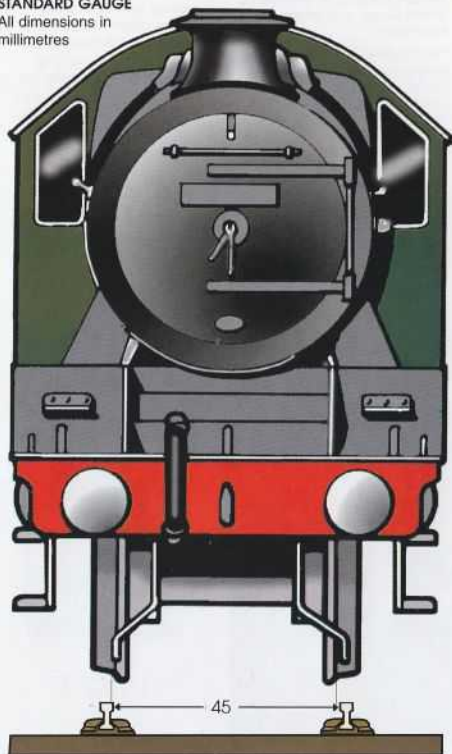

UNDERSTANDING THE GAUGES

There are no frustrating regulations governing the world of railway modelling. From the nine sizes in popular use, you simply choose the gauge and scale best suited to your particular

requirements. For the benefit of those about to begin who might be confused between the terms 'Standard' and 'Narrow' gauges, we would explain that 'Standard' refers to a gauge of 4'-8½", the yardstick from which broad and narrow gauges are defined.

Gauge 0

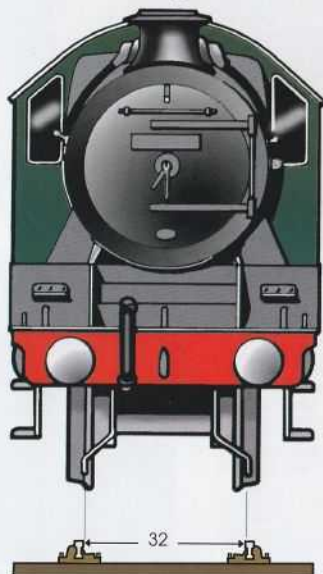

Gauge	STANDARD GAUGE		mm to 1foot
	Scale	Scale	
Z	6.5	1:203	1.5mm
N <i>British</i>	9	1:148	2.062mm
N <i>Overseas</i>	9	1:160	2mm
OO	16.5	1:76	4mm
HO	16.5	1:87	3.5mm
O	32	1:43.5	7mm
1	45	1:30	10mm
NARROW GAUGE			
N-16.5	6.5	1:148	2.062mm
00-9	9	1:76	4mm
HOM	12	1:87	3.5mm
O-16.5	16.5	1:43.5	7mm
SM-32	32	1:19	16mm
G-45	45	1:22.5	13.5mm

HO/OO
GaugeN
GaugeZ
Gauge

THE MODEL GAUGE

NARROW GAUGE

FULL SIZE
NARROW GAUGE
All dimensions in millimetres

N-6.5
Gauge



O0-9
Gauge



O-16.5
Gauge



HOm
Gauge



SM-32
Gauge

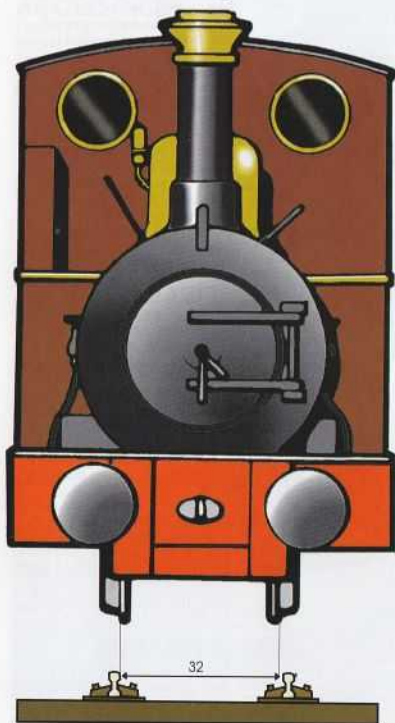

G-45
Gauge

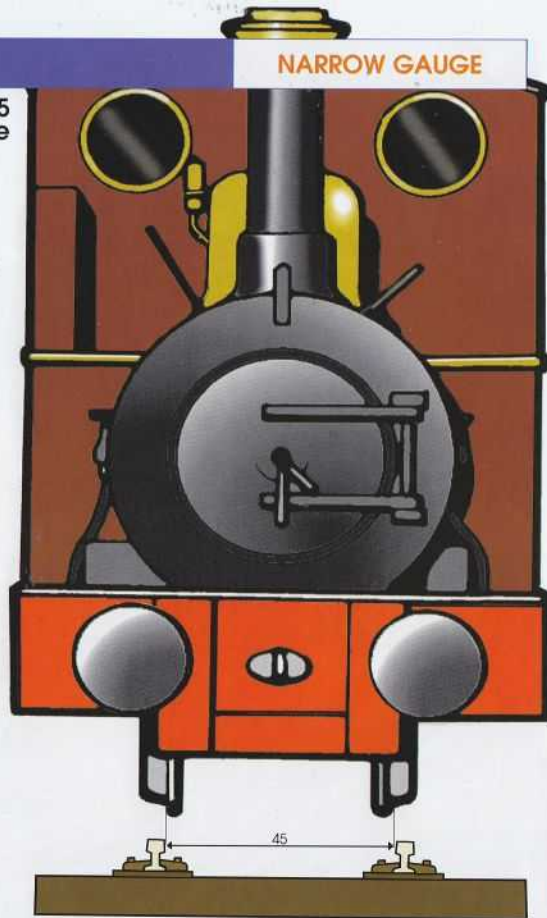



The basis, and indeed the focal point of every model railway is undoubtedly the track. No matter how perfect the locomotives, rolling stock and scenery, if the track is second rate then the whole effect is spoilt. Not only is the appearance ruined, but if the trains do not run reliably, then all the fun that is to be had from operation will be lost.

The three trackage systems produced by Peco; Setrack, Streamline and Individulay cover the needs of every enthusiast, from the absolute beginner through to the experienced, skilled modeller. When only the best is good enough, insist on Peco.

SETRACK

A high quality unit instant trackage system with which to build realistic layouts in the shortest possible time. Available in N, OO/HO and G-45, it is suitable for use with all popular makes of trains in the respective gauges.

Setrack is complementary to the relevant Streamline systems and thus need not be discarded when your railway develops.

OO/HO Setrack is compatible with other unit systems that conform to the British Standard Geometry and can be used to extend most train sets. The solid nickel silver rails will of course never rust which ensures good electrical pick-up.

STREAMLINE

Supplied in flexible lengths, Peco Streamline is the track to use when building a permanent model railway. It is unsurpassed

for high quality and technical innovation. The strong moulded sleeper bases make all but the smallest sizes suitable for garden layouts as well as indoors.

In all scales, both standard gauge and narrow gauge, Streamline is modelled on flat bottom practice. For O gauge the British bullhead rail is also available.

One of the unique features of Streamline standard gauge systems (particularly N Universal Fine and OO/HO) is the clever geometry that allows small, medium and large radius turnouts to be used together or with either the short or long crossings. An almost endless variety of formations can thus be made from the large range available. In N, and OO/HO, Streamline is fully compatible with Peco Setrack.

INDIVIDULAY

A comprehensive series of components that includes rail sections, rail fixings and sleepers with which to build highly realistic track and turnouts to your own precise specifications.

The range covers standard, broad and narrow gauges. In 4mm scale parts are available with which to build 16.5, 18.2 and 18.83 gauge trackwork plus conductor rail chairs that allow for modelling outside third (SR) or centre rail conductor (LT) systems. These can also be used with Streamline.

View of the sheds at Broad Stallich in the OO layout by Julian Birley in the July 1999 issue of Railway Modeller. Photo: Peco Studio.

STANDARD GAUGE TRACK INDEX

SETRACK

N.....	16
OO/HO.....	22

STREAMLINE

Z.....	13
N.....	16
OO/HO.....	27
O.....	36
1.....	40

INDIVIDULAY

4mm scale.....	41
O and 1.....	42

ACCESSORIES

TRACK FIXING PINS SL-14
Blackened mild steel pins,
14mm (9/16in) long. For fixing
Peco Z Streamline to wood fibre
(Sundeala™) or similar
baseboard surfaces.



SL-14

METAL RAIL JOINERS SL-210
For connecting rail ends
together, provide both
mechanical and electrical
bonding. Nickel silver.



SL-210

**WOODEN SLEEPER TYPE
SL-200**

Z and N-6.5 gauges
Supplied in 609mm
(24in) lengths.



SL-200

**STREAMLINE
UNIVERSAL
FLEXIBLE TRACK**

With code 60 rail

Modellers in Z gauge (6.5mm) can enjoy the advantages of Peco Streamline Flexible Track – smooth, sweeping, realistic curves or tight space-saving radii. The finely detailed moulded sleepers have wood grain finish with blind fixing holes underneath for easier track laying. Solid nickel silver rail ensures good electrical pick-up with maximum realism. Ideal for use with Märklin Miniclub™ trains and turnouts.

BALLAST INLAY

Instant realism Moulded Foam Ballast Inlay in realistic brown colour. Supplied in a flexible roll for Streamline track and special moulded units to fit Märklin™ turnout.

Not only does the Inlay add extra realism to your layout but it also gives quieter and smoother running.
Ballast Inlay Track Roll
5 metres (16ft 4in). SL-250



SL-250

Ballast Inlays to fit Märklin™ turnout

Long Crossing Inlay SL-259
(Märklin™ 8559)
Double Slip Inlay SL-260
(Märklin™ 8560)
R/H and L/H Turnout Inlays
(Märklin™ 8561/8564) SL-261
R/H and L/H Curved Turnout Inlays
(Märklin™ 8567) SL-267

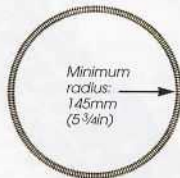
**Narrow Gauge
N-6.5**

In addition to its use for Z standard gauge, this track is also designed for use with N-6.5 narrow gauge. See pages 44 and 67.



NG-651

The photograph below shows Streamline Z Track and Ballast Inlay used together with Märklin turnouts.

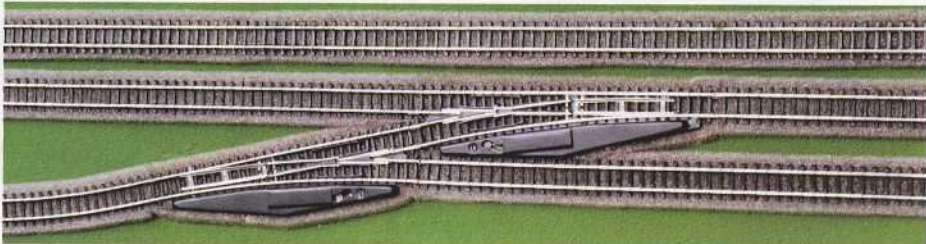



ST-300



N SETRACK STARTER SET

Attractively packaged, the Settrack Starter Set makes an ideal present and contains all the necessary track components for a beginner to build their first N layout. With it, they can make a start having complete freedom of choice regarding locomotives, rolling stock, controller etc.

A comprehensive Planbook is included in the set giving full instructions for the Settrack system and many track plans to inspire you.

STARTER TRACK SET	ST-300
Contents:	
6 x Standard Straights	ST-1
3 x Double Straights	ST-11
5 x No. 1 Radius Standard Curves	ST-3
6 x No. 1 Radius Double Curves	ST-12
1 x Right Hand Turnout	ST-5
1 x Left Hand Turnout	ST-6
2 x Buffer Stops, Sleeper Built	ST-8

2 x Power Connecting Clips

1 x Planbook

Contents may vary. Ballast Inlays are not included.

All setrack items are available separately.

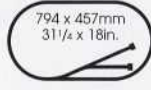

STRAIGHT AND CURVED TRACK UNITS

Standard Straight	ST-1
Length 87mm (3 7/16 in)	
Double Straight	ST-11
Length 174mm (6 7/8 in)	
Short Straight	ST-2
Length 58mm (2 5/16 in)	

No. 1 RADIUS CURVES
228mm (9 in)

No.1 Rad. Standard Curve	ST-3
22 1/2' angle, 16 per circle	
No.1 Rad. Double Curve	ST-12
45' angle, 8 per circle	
No.1 Rad. Half Curve	ST-4
11 1/4' angle, 32 per circle	

No. 2 RADIUS CURVES
263.5mm (10 3/8 in)

No.2 Rad. Standard Curve	ST-14
22 1/2' angle, 16 per circle	
No.2 Rad. Double Curve	ST-15
45' angle, 8 per circle	

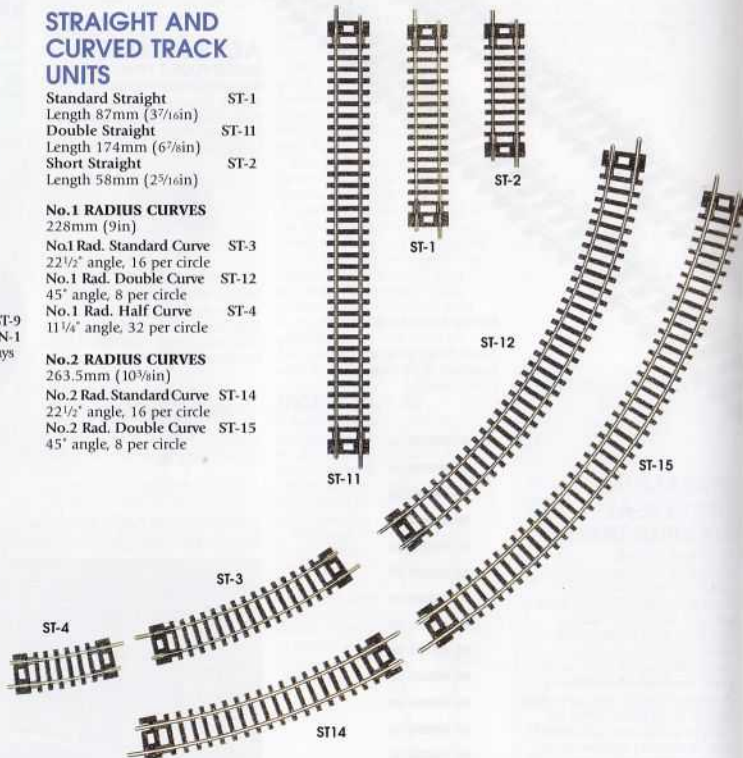

Build any one of these three layouts or develop one of your own

N SETRACK

With code 80 rail

Peco N Settrack is a high quality unit trackage system that is suitable for use with all popular makes of N scale model trains.

N Settrack is fully compatible with N Streamline (both Universal and Fine) and therefore need never be discarded when your layout develops into a permanent system.

TURNOUTS AND CROSSING

With code 80 rail

The solid nickel silver rails of Peco Setrack N Insulfrog* Turnouts and Crossing are integrally moulded into the sleeper bases for maximum realism and strength.

Fitted with an over-centre spring for immediate hand control, no extra levers to buy or fit.

* See page 4 for details on Insulfrogs.

SMALL, No.1 RADIUS TURNOUTS

Radius: 228mm (9in)
Angle: 22½° Length: 87mm (3 7/16 in)

Insulfrog, Right hand ST-5
Insulfrog, Left hand ST-6

SHORT CROSSING ST-7
Frog angle: 25° Length: 91mm (3 13/32 in)

BALLAST INLAY

Instant realism

Moulded Foam Ballast Inlay in realistic brown colour. Supplied in a flexible roll for track (fits both straight units and curves) and special moulded units to fit the turnouts and crossing.

Ballast Inlay Track Roll SL-350
5 metres (16ft 4in)

Ballast Inlays for No.1 Radius Turnouts
Small, No.1 Radius R/Hand Inlay SL-348

Small, No.1 Radius L/Hand Inlay SL-349

Short Crossing Inlay SL-354



ST-6

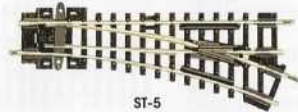

ST-5



ST-7

Ballast Inlay adds extra realism to your layout and gives quieter, smoother running



SL-350

LEVEL CROSSING SYSTEM

This Setrack Level Crossing with its unique 'Addon' Track Unit allows for single or multiple tracks. It is supplied complete with ramps and traditional type gates.

Modern style Barriers (NB-51) are available separately and can be substituted instead of the gates supplied.

The units are equally suitable for use with Peco N Streamline.

Straight Level Crossing (complete) ST-20

With straight track unit, 2 ramps, and 4 gates.

Straight Track Addon Unit ST-21



ST-20



ST-21

ACCESSORIES

Power Connecting Clips ST-9
Simply attach the wires from the output terminals of the controller to these clips and connect to opposing rails. Also suitable for use with N Streamline.

Sleeper Built Type Buffer Stop ST-8

One piece brown plastic moulding with slots to locate onto the track. Simulated wood grain finish sleeper sides with ballast textured surface on top.



ST-9

ST-8

PLATFORM SYSTEM

A new versatile platform system for N Gauge enthusiasts which is easy to assemble and adapt to your requirements. Cut Platform surfaces to any one of three widths, just follow the scribed lines on the back; ramps can be made to one or two widths. Add side walls and join as many units together as you need.

2 Platform Units + 2 Ramps ST-90

Brick Type 2 Platform Units + 2 Ramps ST-90

Stone Type 2 Platform Units only ST-91

Brick Type 2 Platform Units only (to extend ST-90) ST-93

Stone Type 2 Platform Units only (to extend ST-91) ST-94

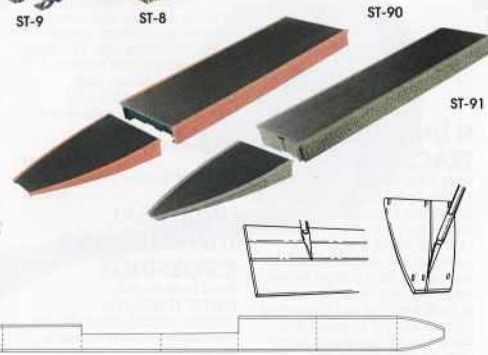

ST-90

ST-91

therefore cannot be used as direct replacements.

A wide range of accessories adds further scope for those modelling in this space-saving scale.

Suitable for all makes of N trains, it is fully compatible with N Setrack.

N FLEXIBLE TRACK

Universal N Streamline flexible track is available with a choice of finely detailed, traditional wooden type sleepers or the modern concrete type. The latter is increasingly used the world over in conjunction with continuously welded rail.

Both types have solid nickel silver rail.

Wooden Sleeper Type Track SL-300

Concrete Sleeper Type Track SL-302

UNIVERSAL TURNOUTS AND CROSSINGS

With code 80 rail
CATCH TURNOUTS
Railways around the world use thousands of Catch Turnouts, the sole purpose of which is

safety. Sidings have them installed to guard against runaway vehicles or incorrect train movement ending up on the main line.

The function of the Catch Turnout is simply to derail the errant vehicles and thus avoid a major accident. Make sure your layout is likewise protected. Length: 86mm (3³/₈in).

Catch Turnout, Right Hand SL-384

Catch Turnout, Left Hand SL-385

SMALL RADIUS TURNOUTS
Use Peco N Setrack turnouts, see page 15.

MEDIUM RADIUS TURNOUTS
The most popular radius, suitable for most situations.

Nominal radius: 457mm (18in)
Angle: 14°

Length: 123.7mm (4⁷/₈in)
Med. Rad. Insulfrog, R/Hand SL-395

Med. Rad. Insulfrog, L/Hand SL-396

Med. Rad. Electrofrog, R/Hand SL-E395

Med. Rad. Electrofrog, L/Hand SL-E396

MEDIUM RADIUS 'Y' TURNOUT
A space saving design. Two Y turnouts 'toe-to-toe' can be used instead of a double slip. A most useful turnout for a variety of situations.

Nominal radius: 762mm (30in)
Angle: 8°

Length: 127mm (5in)
Medium Radius Y, Insulfrog SL-397

Medium Radius Y, Electrofrog SL-E397

LARGE RADIUS TURNOUTS
The last word in scale realism with its long smooth curve.

Nominal radius: 914mm (36in)
Angle: 8°

Length: 160mm (6²/₈in)
Large Rad. Insulfrog, R/Hand SL-388

Large Rad. Insulfrog, L/Hand SL-389

Large Rad. Electrofrog, R/Hand SL-E388

Large Rad. Electrofrog, L/Hand SL-E389

CURVED DOUBLE RADIUS TURNOUTS

Extremely useful for overcoming awkward situations and providing alternative attractive formations.

Nominal Radii: Outside, 914mm (36in) Inside, 457mm (18in)
Angle 10°

Length: 157mm (6¹/₈in)
Curved D/Rad. Insulfrog, R/Hand SL-386

Curved D/Rad. Insulfrog, L/Hand SL-387

Curved D/Rad. Electrofrog, R/Hand SL-E386

Curved D/Rad. Electrofrog, L/Hand SL-E387

SHORT CROSSING

Use Peco N Setrack crossing, see page 15.

LONG CROSSING

A high-speed crossing. Together with two large radius turnouts (not suitable for use with Setrack or medium radius turnouts.) it forms a double junction.

Angle: 8°
Length: 187mm (7³/₈in)
Long Crossing, Insulfrog only SL-394

Long Crossing, Electrofrog only SL-394

TURNOUT MOTOR

For the remote control of N turnouts, plus switches and other electrical accessories, see Peco Lelectrics on page 50



SL-300



SL-302



SL-385



SL-384

SL-395
SL-E395SL-396
SL-E396

N UNIVERSAL TRACKAGE SYSTEM

With code 80 rail
The ever popular Peco Streamline Universal Trackage system for N. It offers a choice of either wooden type or concrete type sleepers flexible track and a truly comprehensive range of turnouts and crossings in both Insulfrog and Electrofrog types. It should be noted that the geometry is different to the code 55 track system and

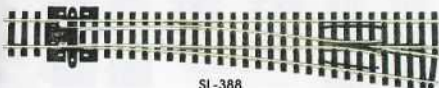
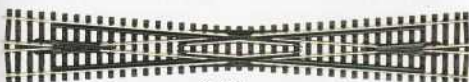
SL-397
SL-E397SL-389
SL-E389SL-388
SL-E388SL-387
SL-E387SL-386
SL-E386

SL-394

BALLAST INLAY

Moulded Foam Ballast Inlay in realistic brown colour. Supplied in flexible rolls for track, and moulded units to fit the respective N Universal turnouts and crossings.

Not only does the inlay add extra realism to your layout but it also gives quieter, smoother running.

Ballast Inlay Track Roll SL-350
5 metres (16ft 4in), suitable for both Universal and Universal Fine N Streamline.

Ballast Inlays for N Universal Turnouts and Crossings

These inlays fit N Universal turnouts only – see page 19 for N Universal Fine.

Catch Turnout Right Hand Inlay SL-361

Catch Turnout Left Hand Inlay SL-362

Small Radius* Right Hand Inlay SL-348

(*Setrack ST-5, see page 15)

Small Radius* Left Hand Inlay SL-349

(*Setrack ST-6, see page 15)

Medium Radius R/Hand Inlay SL-351

Medium Radius L/Hand Inlay SL-352

Medium Radius Y Inlay SL-353

Large Radius & Curved Double Radius R/Hand Inlay SL-368

Large Radius & Curved Double Radius L/Hand Inlay SL-369

Short Crossing* Inlay SL-354

(*Setrack ST-7, see page 15)

Long Crossing Inlay SL-370



Ballast inlay adds extra realism to your layout and gives quieter smoother running. It is both 'instant' and clean to use.



SL-350

ACCESSORIES

AWS Ramp SL-345

Detailed moulding of the ramp/protective cover for the Automatic Warning System used on British railway routes.

Track Fixing Pins SL-14

Blackened mild steel pins, 14mm (9/16in) long. Suitable for fixing Peco Streamline to wood fibre (Sundeala™) or similar baseboard surfaces.

Metal Rail Joiners SL-310

For connecting rail ends together, provide both mechanical and electrical bonding. Nickel silver.

Insulating Rail Joiners SL-311

Moulded in nylon for joining rail where an electrical break is required.

Rail Built Type Buffer Stop SL-340

Super detailed model of the standard British railways type. Three plastic moulded parts which when assembled clip onto the rails.

Sleeper Built Type Buffer Stop ST-8

One piece brown plastic moulding with slots to locate onto the track. Simulated wood grain finish sleeper sides with ballast textured surface on top.



SL-311



SL-345



SL-340

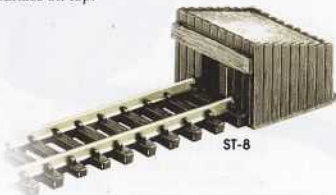

ST-8



Six-Foot Way Gauge SL-336

A small but very useful item for accurately laying Streamline (and Setrack) to correct double track spacing. It also gauges correct platform height relative to rail height.

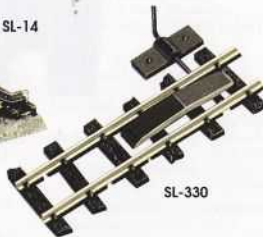

SL-330

DECOUPLERS

For automatically uncoupling locomotives and rolling stock. **Electro-Magnetic Decoupler** PL-25

Designed specially for use with Peco Elsie (ELC) Couplings, see page 59.

Manual Decoupler SL-330

Uncouples by vertical action operated by side lever. For use with Peco Elsie (ELC) couplings and most other makes.

N TURNOUT AND CROSSING PLANS

Universal Code 80
Planning is often a difficult procedure. By using these full size plans/templates you need not take any chances.

To obtain your free set of plans, send a large SAE together with a label from a length of N Streamline track to:

*Peco Technical Advice Bureau
Beer, Seaton, Devon
EX12 3NA, England*

PECO Streamline Universal Standard N TURNOUT AND CROSSING PLANS (Code 80)

Use these plans for Universal Standard N track formations only. See separate plan sheet for Universal Finerails.

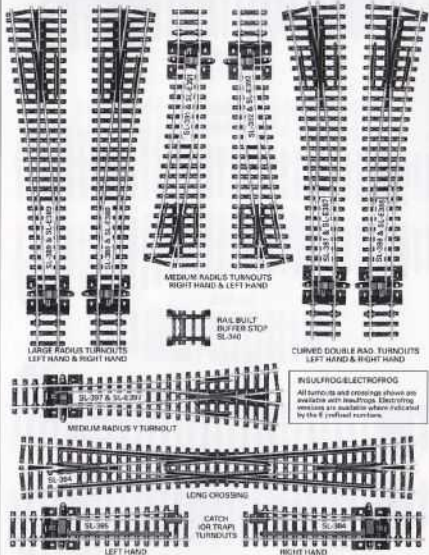

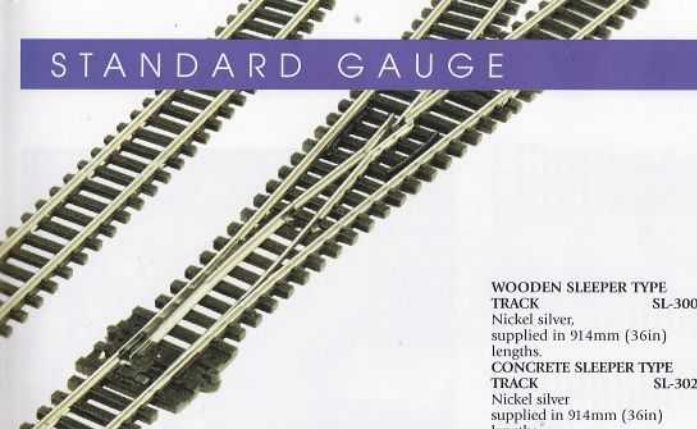

combines strength with realism and can be readily joined to Peco Universal N trackage and other makes with .080in rail. Universal N Joiners (SL-310) are used. Additional sleepers (SL-308F or SL-309F) enable correct sleeper spacing to be maintained at rail joins.

Universal Fine turnouts are available with Electrofrog only. It is important to note that these cannot be used as a direct replacement for code 80 since the geometry is different.

UNIVERSAL FINE TRACKAGE SYSTEM

With code 55 rail Now you can have even greater realism, with Peco Streamline Universal Fine N flexible track. Despite the low visible rail height of only .055in - all makes of British and Continental locomotives and rolling stock will operate on it. Due to the clever design rail section Peco Universal Fine

WOODEN SLEEPER TYPE TRACK SL-300F

Nickel silver, supplied in 914mm (36in) lengths.

CONCRETE SLEEPER TYPE TRACK SL-302F

Nickel silver supplied in 914mm (36in) lengths

UNIVERSAL FINE TURNOUTS AND CROSSINGS

With code 55 rail

All Universal Fine turnouts and crossings have a common frog angle of 10° which means that it is possible to combine different size turnouts together, thus creating interesting track formations. The end sleepers are detached for ease of fitting the rail joiners. Full instructions included with each turnout.

SMALL RADIUS TURNOUTS

Ideal for when space is at a premium, eg. on minimum space layouts and in hidden sidings, marshalling and 'fiddle' yards. Nominal radius: 305mm (12in) Angle: 10°

Length: 123mm (4⁷/₁₆in)
Small Rad. R/Hand, Electrofrog SL-E391F
Small Rad. L/Hand, Electrofrog SL-E392F

MEDIUM RADIUS Y TURNOUT

A space saving design with many useful applications. Nominal radius: 610mm (24in) Angle: 10°
Length: 124.4mm (4²⁹/₁₆in)
Medium Radius Y, Electrofrog SL-E397F

MEDIUM RADIUS TURNOUTS

A popular choice that is suitable for most situations. Nominal radius: 457mm (18in) Angle: 10°
Length: 137mm (5³/₁₆in)
Med Rad. Electrofrog, R/Hand SL-E395F
Med Rad. Electrofrog, L/Hand SL-E396F

LARGE RADIUS TURNOUTS

These turnouts, with their pleasing large 'gradual' curve, offer maximum realism. Nominal radius: 914mm (36in) Angle: 10°
Length: 164mm (6⁷/₁₆in)
Large Rad. Electrofrog, R/Hand SL-E388F
Large Rad. Electrofrog, L/Hand SL-E389F



SL-300F



SL-302F



SL-E397F



SL-E391F



SL-E395F



SL-E396F



SL-E388F



SL-E389F



SL-E388F

UNIVERSAL FINE TURNOUTS AND CROSSINGS

continued

CURVED DOUBLE RADIUS TURNOUTS

Curved turnouts overcome awkward situations and add extra interest to a layout.

Nominal radii: Outside, 914mm (36in) Inside, 457mm (18in)
Length: 159.5mm (6⁹/₃₂in)

Curved D/Rad, R/Hand Electrofrog SL-E386F
Curved D/Rad, L/Hand Electrofrog SL-E387F

LONG CROSSING

Perfect for double junctions. Can be used with small, medium and large turnouts.

Long Crossing, Insulfrog SL-394F
Long Crossing, Electrofrog SL-E394

Angle: 10°
Length: 154mm (6¹/₁₆in)

SINGLE SLIP

Recently introduced this special turnout makes your layout even more prototypically correct.

Length and angles of the single slip match SL-394E.
Angle: 10° Length: 154mm (6¹/₁₆in)
Single Slip, Electrofrog SL-E380F

Single Slip, Insulfrog SL-380F

DOUBLE SLIP

This product combines four turnouts and a crossing, allowing a wide range of train movements.

Length and angles of the double slip match SL-394F
Angle: 10°

Length: 154mm (6¹/₁₆in)
Double Slip, Electrofrog SL-E390F

Double Slip, Insulfrog SL-390F

SCISSORS CROSSING

An impressive piece of trackwork that incorporates four turnouts and a crossing whilst still maintaining the correct 6ft-way spacing for double track. Of particular use on the approach to a terminal station or anywhere else where space is limited.

For operation, it requires a 4-pole double throw switch (PL-21, see page 51).

Nominal radius: 457mm (18in)
Angles: 10°
Length: 270.84mm (10⁷/₃₂in)

Scissors Crossing, Electrofrog SL-E383F

SHORT CROSSING

Ideal for making scissor crossover's at station junctions.
Angles: 20°

Length 103.7mm (4¹/₃₂ins)
Short Crossing Electrofrog SL-E393F

Short Crossing Insulfrog SL-E393F



SL-394F



SL-E387F



SL-E386F



SL-E380F

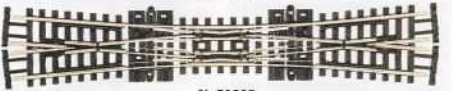

SL-E383F



SL-E390F



SL-E393F

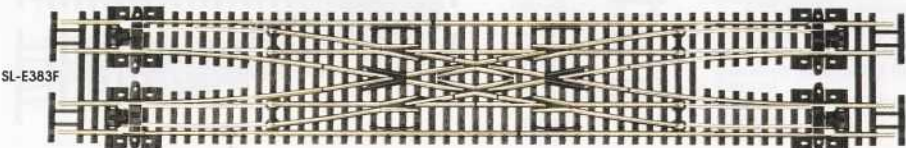

SL-E383F



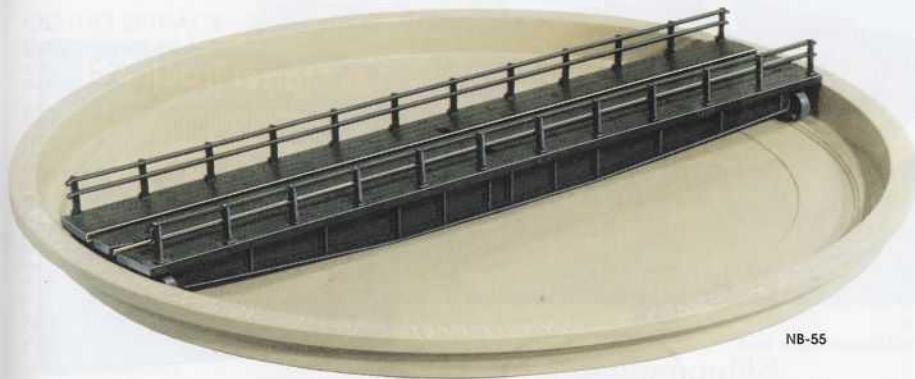

NB-55

WELL TYPE TURNTABLE KIT

NB-55

This easily assembled model is based on a Ransome and Rapier™ 73ft well type turntable, supplied to many railways both at home and overseas. The deck length is 151mm (5¹³/₁₆in). A hole of 155mm (6¹/₁₆in) dia. should be cut in the baseboard to accommodate it.

The kit contains detailed plastic mouldings, rail and electrical contacts. As supplied, the deck is rotated by hand, but it can be mechanised and motorised if desired using Meccano™ or similar components.

Suitable for use with both the Universal and Universal Fine Peco N Streamline trackage

systems.

An essential and interesting addition for all N gauge layouts.

Comprehensive and fully illustrated instructions are included.

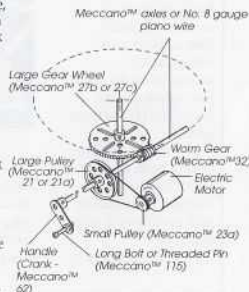

BALLAST INLAY

Moulded Foam Ballast Inlay in realistic brown colour. Supplied in flexible rolls for track and special moulded units to fit the medium radius turnouts only.

Ballast Inlay Track Roll

SL 350

5 metres (16ft 4in), suitable for N Universal Fine (and N Universal Streamline).

Ballast Inlays for Universal Fine N Turnouts and Crossings

These inlays only fit Universal Fine Turnouts and Crossings. See page 17 for Universal inlays.

Med. Radius Right Hand Inlay

SL-351F

Med. Radius Left Hand Inlay

SL-352F



SL-350



SL-351F

SL-352F

ACCESSORIES

Due to the clever design of N Universal Fine trackwork the same accessories are used for connecting the track etc.

TRACK FIXING PINS

Blackened mild steel pins, 14mm (9/16in) long. SL-14

METAL RAIL JOINERS

Nickel Silver. SL-310

INSULATING RAIL JOINERS

Nylon - use for electrical breaks. SL-311

ADDITIONAL SLEEPERS

Wooden (24)

SL-308F

Concrete (24)

SL-309F



SL-14



SL-310

SL-311



SL-308F



SL-309F

TURNOUT AND CROSSING PLANS

Universal code 55

These full size plans/templates make planing your layout easy leaving nothing to chance.

To obtain your free set of plans, send a large SAE together with a label from a length of N Streamline to:

Peco Technical Advice Bureau
Beer, Seaton, Devon
EX12 3NA,
England

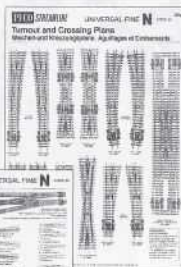

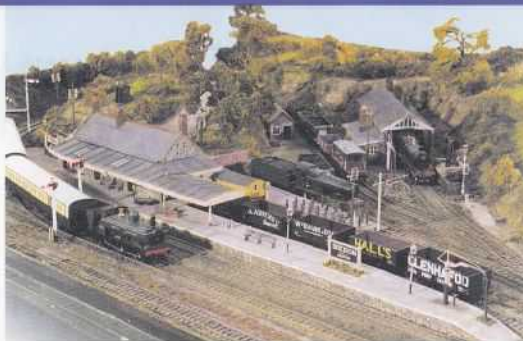

OO/HO SETRACK STARTER TRACK SET

An ideal way to build your very first OO/HO layout. Attractively packaged, this Starter Set makes an ideal present and contains all the necessary track components for a beginner to build their first OO/HO layout.

Peco OO/HO Setrack is a high quality unit trackage system that is suitable for use with all popular makes of model trains – thus you can make a start with complete freedom of choice regarding locos, rolling stock, controller etc.

A comprehensive Planbook is included in the set giving full instructions for the Setrack system and many track plans to inspire you.

OO/HO Setrack Starter Track Set ST-100

Contents:

7 x No.2 Rad. Double Curves	ST-226
2 x No.2 Rad. Standard Curves	ST-225
5 x Double Straights	ST-201
3 x Standard Straights	ST-200
1 x Right Hand Turnout	ST-240
1 x Left Hand Turnout	ST-241
1 x Short Straight	ST-202
2 x Buffer Stops, Sleeper Built	ST-270
2 x Decoupling Units	ST-271
1 x pair Power Connecting Clips	ST-273
1 x Planbook	STP-00

Contents may vary. Ballast Inlays not included in set. All setrack items are available separately

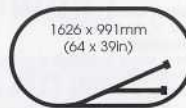
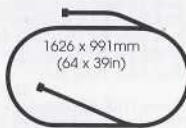

Use the Setrack components in the set to build any one of the layouts shown above or to develop your own ideas.

ST-100

OO/HO SETRACK PLANBOOK STP-00

The first essential. More than just a book of plans, it contains helpful instructions and other useful information to assist you develop your own OO/HO Setrack system.

The range of plans covers both large and small layouts and features continuous and end-to-end type systems.

An introduction to



adding simple scenery is included along with photographs and sketches all designed to inspire you.

**OO/HO SETRACK
RIGID UNIT TRACK**

With code 100 nickel silver rail
Wooden sleeper type

STRAIGHT UNITS

Special Short Straight	ST-203
Length 41mm (1 ⁵ / ₁₆ in)	
Short Straight	ST-202
Length 79mm (3 ¹ / ₁₆ in)	
Standard Straight	ST-200
Length 168mm (6 ⁵ / ₁₆ in)	
Double Straight	ST-201
Length 335mm (13 ¹ / ₁₆ in)	
Isolating Standard Straight & Switch	ST-205
Length 168mm (6 ⁵ / ₁₆ in)	

**No.1 RADIUS
CURVES**

371mm (14⁵/₁₆in) radius

No.1 Rad. Half Curve	ST-222
11 ¹ / ₄ ° angle, 32 per circle	
No.1 Rad. Standard Curve	ST-220
22 ¹ / ₂ ° angle, 16 per circle	
No.1 Rad. Double Curve	ST-221
45° angle, 8 per circle	

**No.2 RADIUS
CURVES**

438mm (17¹/₁₆in) radius

No.2 Rad. Half Curve	ST-227
11 ¹ / ₄ ° angle, 32 per circle	
No.2 Rad. Standard Curve	ST-225
22 ¹ / ₂ ° angle, 16 per circle	
No.2 Rad. Double Curve	ST-226
45° angle, 8 per circle	

**No.3 RADIUS
CURVES**

504.8mm (19⁷/₁₆in) radius

No.3 Rad. Standard Curve	ST-230
22 ¹ / ₂ ° angle, 16 per circle	
No.3 Rad. Double Curve	ST-231
45° angle, 8 per circle	

SPECIAL CURVE

859.6mm (33⁷/₁₆in) radius

Special Curve	ST-238
11 ¹ / ₄ ° angle, 32 per circle	
For use with Y Turnout	ST-247

Compatible with Streamline

OO/HO Setrack is complementary in every way to the Peco OO/HO Streamline Flexible Trackage System. Because of this, Setrack items need never be discarded when your railway develops. The turnouts, crossings and buffer stops are especially suitable for making instant storage sidings and fiddle yards on permanent layouts as they occupy the minimum of space.

OO/HO Setrack is also compatible with other unit trackage systems (eg. Hornby™) that conform to the British Standard Geometry.

Setrack Ballast Inlay will bring added realism and smooth, quiet running to your layout. It too matches with the Streamline system Inlay. See Page 24.

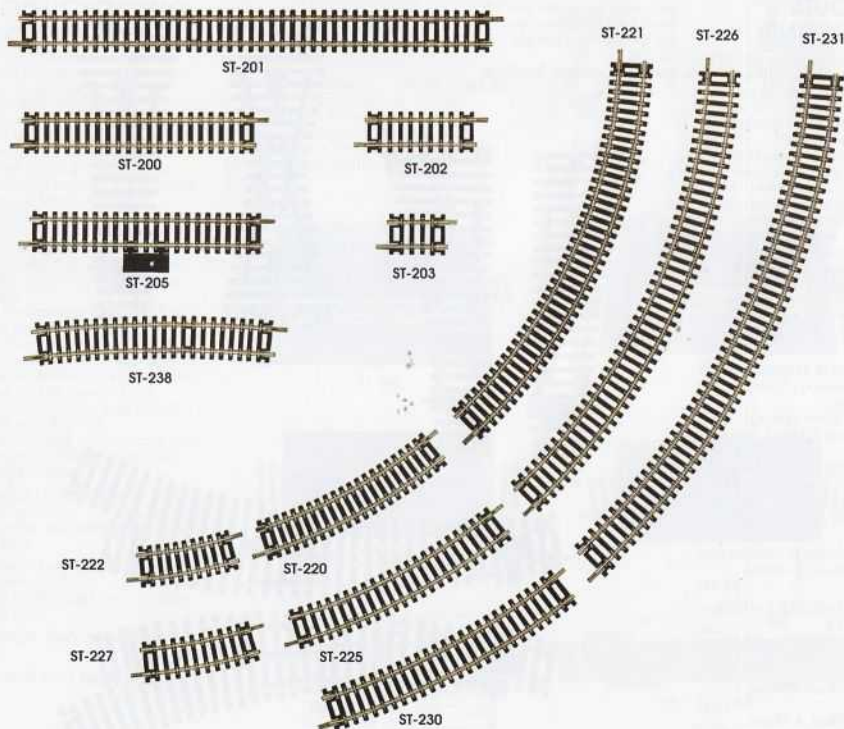

OO/HO SETRACK TURNOUTS & CROSSING

The solid nickel silver rails of Setrack OO/HO Insulfrog* Turnouts and Crossing are integrally moulded into the sleeper bases for maximum realism and strength.

Fitted with an over-centre spring for immediate hand control (no extra levers to buy or fit), they automatically isolate the track not in use.

For remote control on permanent layouts the Peco Turnout Motor PL-10 can be fitted. For this and other electrical accessories for use with OO/HO Setrack see page 50. * See page 4 for details on Insulfrog.

No.2 RADIUS TURNOUTS

Radius: 438mm (17³/₁₆in)

Angle 22¹/₂°

Length: 168mm (6⁹/₁₆in)

No.2 Radius R/Hand, Insulfrog ST-240

No.2 Radius L/Hand, Insulfrog ST-241

MEDIUM RADIUS Y TURNOUT

Radius: 859.6mm (33⁷/₁₆in)

Angle 11¹/₄°

Length: 170mm (6¹¹/₁₆in)

Medium Rad.Y Turnout, Insulfrog ST-247

CURVED DOUBLE RADIUS TURNOUTS

Can be used to connect between

No.2 and No.3 radius.

Angle 11¹/₄°

Curved D/Rad. R/Hand, Insulfrog ST-244

Curved D/Rad. L/Hand, Insulfrog ST-245

CROSSING

The one Universal Crossing Unit suits both right hand and left hand locations when used with the special Short Straight ST-202.

Medium Crossing, Insulfrog ST-250
Frog angle 22¹/₂°



ST-250



ST-247

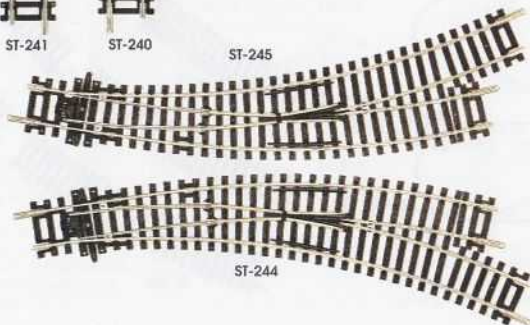

ST-244

BALLAST INLAY FOR OO/HO SETRACK

Moulded Foam Ballast Inlay in realistic brown colour. Supplied in flexible rolls for track (fits both straights and curves) and units to fit the turnouts and crossing.

Not only does the Inlay add extra realism to your layout but it also gives quieter and smoother running.

Ballast Inlay Track Roll SL-50
5 metres (16ft 4in)

Ballast Inlays for Setrack
Turnouts and crossing:
No.2 Radius Right Hand Inlay ST-255

No.2 Radius Left Hand Inlay ST-256

Curved Double Rad. R/Hand Inlay ST-259
Curved Double Rad. L/Hand Inlay ST-260
Medium Crossing Inlay ST-265
Y Turnout Inlay ST-262

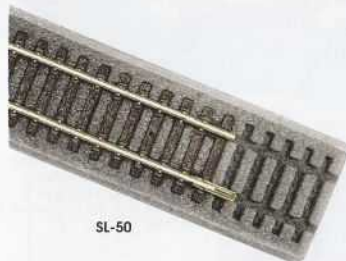

SL-50



SETRACK ACCESSORIES

Fixing Nails ST-280
For permanent layouts, fix the track with these special nails. Holes are provided in some sleepers to accept the nails.



ST-280

Decoupler ST-271
Moulded in brown plastic to resemble planking. Fitted between the rails for use in decoupling locomotives and rolling stock with tension-lock type couplings.



ST-270

Power Connecting Clips ST-273
Simply attach the wires from the controller to these clips and connect to opposing rails. Full instructions are included. Also suitable for use with OO/HO Streamline.



ST-273

Sleeper Built Type Buffer Stop ST-270
One piece brown plastic moulding with white buffer beam and slots to locate onto the track. Simulated wood grain finish sleeper sides with ballast textured surface on top.

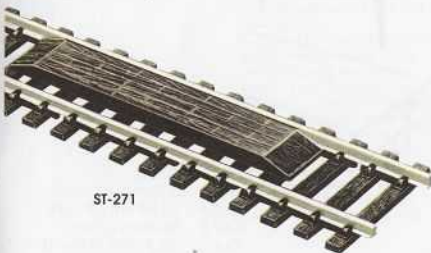

ST-271

OO/HO SETRACK LEVEL CROSSING SYSTEM

These Setrack Level Crossings with their unique *Addon* units can be positioned virtually anywhere on your OO/HO layout.

On table-top layouts, a corner is often the most convenient place to site a level crossing. With this in mind, the standard Setrack Level Crossing is available with a curved track centre section (ST-266) as well as a straight track section (ST-268). Both come complete with traditional wooden type gates.

Modern type Barriers (LK-51) are available separately.

Two separate *Addon* Track Units are available and allow for curved double track (use ST-266 and ST-269 together) and multiple straight track (use ST-268 with ST-264).

These Setrack Level Crossing units are equally suitable for use with Peco Streamline.

Straight Level Crossing (complete) ST-268
Straight track unit, 2 ramps, and 4 gates.

Curved Level Crossing (complete) ST-266
No.1 radius track unit, 2 ramps & 4 gates.

Straight Track Addon Unit ST-264

Curved, No.2 Rad. Addon Unit ST-269

Modern Type Barriers LK-51
Essential on a modern layout, these Barriers with their dummy warning lamp standards come complete with side fences. Detailed plastic mouldings.

Six-Foot Way Gauge SL-36
A useful item for accurately laying OO/HO Setrack (and Streamline) to correct gauge the track spacing. It also gauges the platform height relative to rail level.



LK-51



ST-268



ST-266



ST-264



ST-269

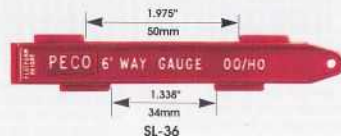
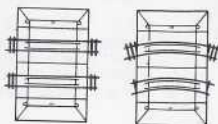



OO/HO PLATFORM SYSTEM FOR SETRACK AND STREAMLINE

This Platform Kit System is not only ideal for use with Peco OO/HO Setrack (and any other unit trackage system that conforms to British Standard Geometry), but it is also equally well suited for use with Peco Streamline. All the variations described below are made possible by using multiples of two basic moulded plastic units – a straight and a ramp.

Straight units are exactly the same length as the standard OO/HO Setrack Straight

(ST-200), 168mm (6 $\frac{5}{16}$ in) and consist of a dark grey simulated Tarmacadam platform top which plugs into two platform edge units and two cross members that add extra rigidity. Self adhesive printed paper strips are supplied to represent either brick or stonework and these are easily applied to the platform edges.

Not only can platforms be assembled to any length but, due to the thoughtful design (three grooves are moulded into the underside of the top section – see illustrations) they can be easily cut and adapted to any of four widths designed specially to fit in with the Setrack geometry.

Ramp units are assembled in the same way and can be cut to

match all four widths of platform. They are 113mm (4 $\frac{7}{16}$ in) long and have curved sloping sides to suit Setrack No.2 radius curves.

Platform, Straight Unit, Brick edging ST-290
 Platform, Straight Unit, Stone edging ST-291
 Platform, Ramp Unit, Brick edging ST-296
 Platform, Ramp Unit, Stone edging ST-297

The photograph above shows three widths of platform with the tracks fitting correctly alongside.

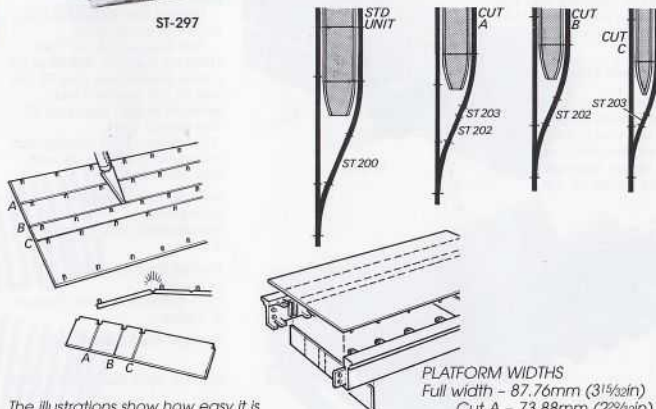

The illustrations show how easy it is to cut the various components to make the different widths of platforms

PLATFORM WIDTHS
 Full width - 87.76mm (3 $\frac{1}{2}$ in)
 Cut A - 73.88mm (2 $\frac{9}{16}$ in)
 Cut B - 55.4mm (2 $\frac{1}{8}$ in)
 Cut C - 45.31mm (1 $\frac{7}{8}$ in)

UNIVERSAL TRACKAGE SYSTEM

With code 100 rail

If you wish to mix wheel standards on your OO/HO layout, this is the trackage to choose. It allows you to use wheels having a flange depth of up to 1.6mm (.063in) and will accommodate all the popular makes of locos and rolling stock.

The wide range of turnouts and crossings in this series includes every type from simple catch turnouts to the delightfully complex looking single and double slips.

Accessories available include both rail and sleeper built buffer stops, decouplers for Simplex and tension-lock (Hornby™) type couplings, foam ballast inlay to fit track and

turnouts and an impressive well-type turntable.

Compatible with Setrack

Streamline Universal OO/HO matches exactly OO/HO Setrack. You can convert a Setrack system using Streamline into a more permanent type layout without discarding any of the Setrack components.

FLEXIBLE TRACK

Universal OO/HO offers you a choice of traditional wooden type sleepers or the modern concrete type. Both are available with solid nickel silver steel rail, whilst the concrete type is also available with brass rail.

Supplied in 914mm (36in) lengths.

WOODEN SLEEPER TYPE TRACK

With Nickel Silver Rail SL-100

CONCRETE SLEEPER TYPE TRACK

With Nickel Silver Rail SL-102
With Brass Rail SL-102B

TURNOUTS AND CROSSINGS

with code 100 rail

Available with Insulfrogs or Electrofrogs except the double slip and long and short crossings.

Every turnout is complete and ready for hand operation – there is no need to buy extra

levers or switches. For remote control, the Peco Lectrics Turnout Motor PL-10 (see page 50) clips underneath.

Because turnouts and crossings have a common frog angle of 12° or 24° interesting track formations can be easily constructed. See page 29 'Clever Geometry' and Turnout & Crossing Plans!

CATCH TURNOUTS

Catch Turnouts protect main lines from runaway vehicles by derailing them. They are situated mainly at sidings close to where they join the main line and at the bottom of inclines.

Length: 98mm (37/8in.)

Right Hand Catch

SL-84

Left Hand Catch

SL-85

SMALL RADIUS Y TURNOUT

A very useful space saving turnout. Nominal radius: 610mm (24in)

Angle: 24°

Length: 148mm (5 13/16in)

Small Rad. Y, Insulfrog SL-97

Small Rad. Y, Electrofrog SL-E97

LARGE RADIUS Y TURNOUT

Provides for long, sweeping Y junctions and other realistic formations. Particularly useful for station approach roads.

Nominal radius: 1828mm (72in)

Angle: 12° Length: 220mm

(8 23/32in)

Large Rad.Y, Insulfrog SL-98

Large Rad.Y, Electrofrog SL-E98



SL-100



SL-102



SL-84



SL-85



SL-97
SL-E97



SL-98
SL-E98

UNIVERSAL TURNOUTS AND CROSSING

continued

With code 100 rail
SMALL RADIUS TURNOUTS
Ideal for where space is at a premium. They can be used to advantage in goods yards and hidden sidings to provide maximum storage space.
Nominal radius: 610mm (24in)
Angle: 12°

Length: 185mm (7⁹/₃₂in)
Small Rad. R/H, Insulfrog SL-91
Small Rad. L/H, Insulfrog SL-92
Small Rad. R/H, Electrofrog SL-E91
Small Rad. L/H, Electrofrog SL-E92

MEDIUM RADIUS TURNOUTS
The 'happy medium', ideal for use on most layouts.

Nominal radius: 914mm (36in)
Angle: 12°
Length: 219mm (8⁵/₁₆in)
Med. Rad. R/H, Insulfrog SL-95
Med. Rad. L/H, Insulfrog SL-96
Med. Rad. R/H, Electrofrog SL-E95
Med. Rad. L/H, Electrofrog SL-E96

**MEDIUM RADIUS 3-WAY
TURNOUTS**

A great space-saver, gives a choice of three directions in a length of only 220mm (8²³/₃₂in) enabling you to have the maximum number of tracks in the minimum of space.
Nominal radii: 914mm (36in) and 610mm (24in)
Angles: 12°
Length: 220mm (8²³/₃₂in)
Med. Rad. 3-Way, Insulfrog SL-99
Med. Rad. 3-Way, Electrofrog SL-E99



SL-91
SL-E91

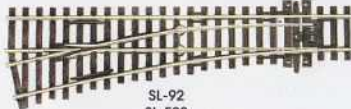

SL-92
SL-E92



SL-95
SL-E95



SL-96
SL-E96



SL-99
SL-E99

LARGE RADIUS TURNOUTS
The last word in scale realism with a long gradual curve. Whenever space permits these are the turnout to use.

Nominal radius: 1524mm (60in)
Angle: 12°
Length: 258mm (10¹/₁₆in)
Large Rad. R/H, Insulfrog SL-88
Large Rad. L/H, Insulfrog SL-89
Large Rad. R/H, Electrofrog SL-E88
Large Rad. L/H, Electrofrog SL-E89

SL-88
SL-E88



SL-89
SL-E89

SL-86
SL-E86



SL-87
SL-E87

**CURVED DOUBLE RADIUS
TURNOUTS**

Beautiful examples of the prototype in miniature. Curved turnout overcome awkward situations and add visual interest to the layout.

Nominal Radii:
Outside, 1524mm (60in)
Inside, 762mm (30in)
Length: 256mm (10¹/₁₆in)

Curved D/Rad. R/H, Insulfrog SL-86
Curved D/Rad. L/H, Insulfrog SL-87
Curved D/Rad. R/H, Electrofrog SL-E86

Curved D/Rad. L/H, Electrofrog SL-E87



UNIVERSAL TURNOUTS AND CROSSING

continued

LONG CROSSING

A useful item of trackwork for double junctions and other formations.

Angle: 12°
Length: 249mm(9¹³/₁₆in)
Long Crossing, Insulfrog (only)
SL-94

DOUBLE SLIP

A masterpiece of OO/HO turnout production and invaluable on any layout since it is in effect the combination of four turnouts and a crossing all in one. It allows train movement in a variety of directions.

Length and angles match the long crossing SL-94.
Angle: 12°
Length: 249mm(9¹³/₁₆in)
Double Slip, Insulfrog (only)
SL-90

SINGLE SLIP

This will make your layout even more prototypically correct. Use it for the exit to a goods yard to avoid having a facing turnout on a main running line.

Length and angles match the long crossing SL-94.
Angle: 12°
Length: 249mm(9¹³/₁₆in)
Single Slip, Insulfrog (only)
SL-80



SHORT CROSSING

Can be used to build scissor cross-overs and Y double junctions. A most useful space saver.

Angle: 24°
Length: 127mm(5in)
Short Crossing, Insulfrog (only)
SL-93

For Ballast Inlays, see page 30

CLEVER GEOMETRY

One of the unique features of Peco OO/HO Streamline is the clever geometry that allows

small, medium and large radius turnouts to be used with either short or long crossings. An almost endless variety of formations can thus be made from the large range available. See the turnout and crossing plan sheet for more information.

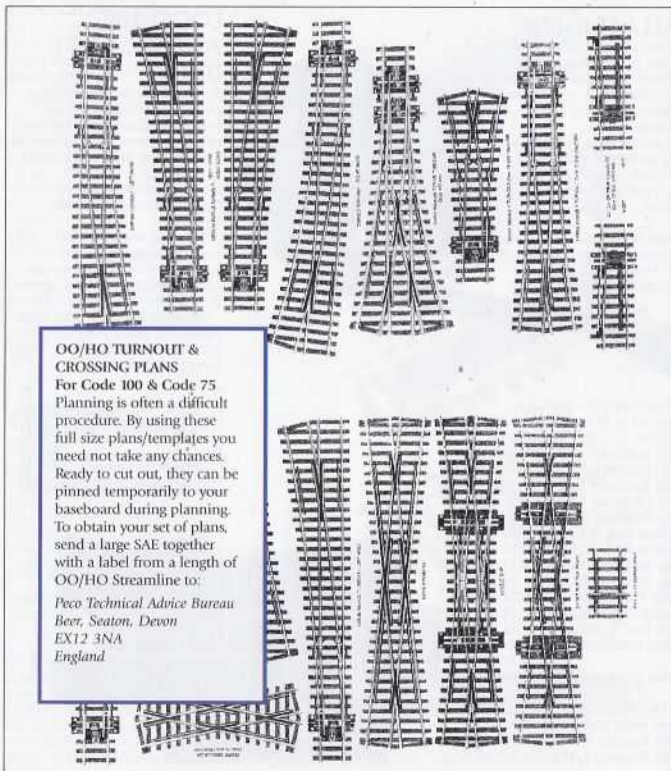

OO/HO TURNOUT & CROSSING PLANS

For Code 100 & Code 75

Planning is often a difficult procedure. By using these full size plans/templates you need not take any chances. Ready to cut out, they can be pinned temporarily to your baseboard during planning. To obtain your set of plans, send a large SAE together with a label from a length of OO/HO Streamline to:

*Peco Technical Advice Bureau
Beer, Seaton, Devon
EX12 3NA
England*

BALLAST INLAY

Moulded Foam Ballast Inlay in realistic brown colour. Supplied in flexible rolls for track, and special moulded units to fit the respective turnouts and crossings.

Not only does the Inlay add extra realism to your layout but it is quick, easy and clean to use, also it gives quieter, smoother running.

Ballast Inlay Track Roll SL-50
5 metres (16ft 4in), suitable for both Universal and Fine OO/HO Streamline.



SL-50

Ballast Inlays for Turnouts

Designed to fit both Universal and Fine OO/HO Turnouts.

Small Radius R/H Inlay	SL-51
Small Radius L/H Inlay	SL-52
Small Radius Y Inlay	SL-53
Short Crossing Inlay	SL-54
Long Crossing Inlay	SL-57
Medium Rad. R/H Inlay	SL-59
Medium Rad. L/H Inlay	SL-60
Large Rad. R/H Inlay	SL-55
Large Rad. L/H Inlay	SL-56
Single Slip Inlay	SL-63
Double Slip Inlay	SL-64
Large Rad. Y Inlay	SL-68
Curved Double Rad. R/H Inlay	SL-66

Curved Double Rad. L/H Inlay
SL-67

Fits Universal only.

3-Way Med. Rad. Inlay	SL-69
Catch Turnout R/H Inlay	SL-61
Catch Turnout L/H Inlay	SL-62

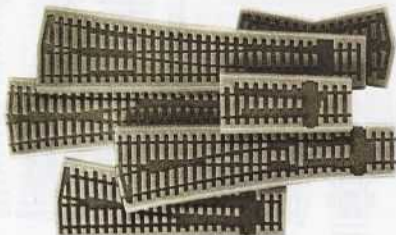
**LOCO-LIFT AND STORAGE UNIT**

SL-43

This versatile unit is designed primarily for use in storage sidings, facilitating the removal of a locomotive from the end of an incoming train and placing it at the opposite end. It eliminates handling the locomotive and prevents damage.

The rails within the Loco-lift are automatically electrified when it is placed on the track and the whole train can be run through it.

Stacking beams at both ends enable the units to be used for locomotive storage.
Length: 305mm (12in)

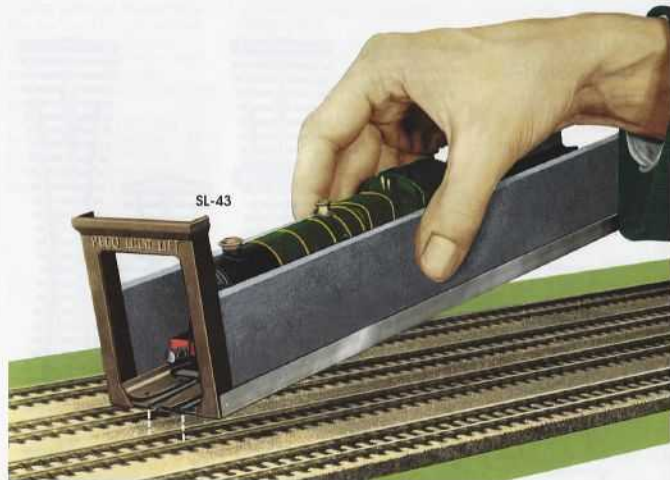
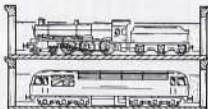

SL-43

ACCESSORIES

AWS Ramp SL-45

Detailed moulding of the ramp/protective cover for the Automatic Warning System used on British railway routes.

This dummy unit will add that touch of extra realism to your layout.



SL-45

Expansion Joint Kit SL-44

Technically known as a 'breather switch' and used between sections of continuously welded rail. Brings your layout right up to date. Length of unit, 86mm (3 3/8in).



SL-44

UNIVERSAL ACCESSORIES

TRACK FIXING PINS SL-14
Blackened mild steel pins, 14mm (9/16in) long. For fixing Peco Streamline to wood-fibre board (Sundeala™) or similar baseboard surfaces.



SL-14

METAL RAIL JOINERS

For connecting rail ends together. Provides both mechanical and electrical bonding. Nickel silver or brass.

Metal Rail Joiners, n/s (code 100) SL-10

Metal Rail Joiners, Brass (code 100) SL-10B



SL-10

INSULATING RAIL JOINERS

SL-11 (code 100) Moulded in nylon for joining rail where an electrical break is required.



SL-11

DUAL STANDARD JOINERS

SL-112 For joining code 100 to code 75

Moulded in plastic with separate metal inserts, can be used either for insulation or where electrical continuity is required. Special sleepers are included in the pack to maintain correct spacing at joints.



SL-112

BUFFER STOPS

Rail Built Type Buffer Stop SL-40

Detailed model of the standard British railways type. Three plastic moulded parts which when assembled clip onto the rails.

Sleeper Built Type Buffer Stop SL-41

Extremely realistic – simulated wood grain mouldings with ballast textured surface on top. Recessed to take couplings.



SL-40



SL-41

DECOUPLERS

For automatically uncoupling locomotives and rolling stock.
Magni-Simplex Decoupler SL-32
A special permanent magnet for use with Peco Magni-Simplex couplings (R-3).

See *Magni-Simplex Couplings*, page 62.

Type RH Decoupler SL-29
For use with Hornby™, Lima™ and other tension-lock couplings. Moulded in brown plastic to resemble planking.

Type A/HD Decoupler SL-30
For use with Peco Simplex couplings (R-2) and original Hornby-Dublo™ couplings. Moulded in brown plastic to resemble check rails. Can be used with O-16.5.

Type T Decoupler SL-31
As type A/HD, but for Trix™ couplings.

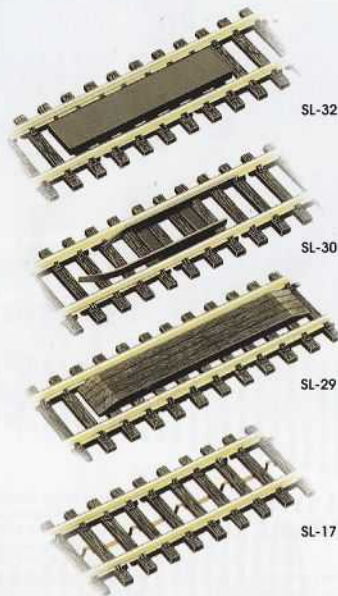

SL-32

SL-30

SL-29

SL-17

STUD CONTACT STRIP

Fits under OO/HO Setrack and Streamline for use with the Mikulin™ system. Not recommended for use with Ballast Inlay.

Stud Contact Strip for tracks 1828mm (72in) SL-17

Stud Contact Strip for turnouts and crossing 1219mm (48in) SL-18

Six-Foot Way Gauge SL-36

A small, but very useful item. Use it for accurately laying OO/HO Streamline (and Setrack) to correct double track spacing. It also gauges the platform height relative to rail level.





LK-55

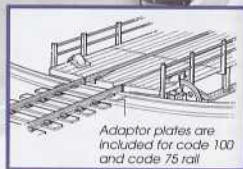
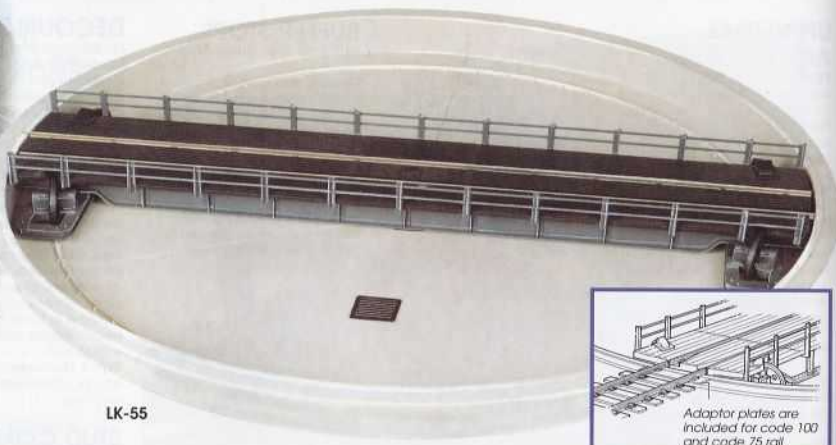

WELL TYPE TURNTABLE KIT

LK-55

This easily assembled model is based on a Ransome and Rapier™ well type turntable, supplied to many railways both at home and overseas. The deck length is 305mm (12in). A hole 308.16mm (12⁵/₃₂) dia. needs to be cut into the baseboard to accommodate it.

The kit contains detailed plastic mouldings, rail and electrical contacts. As supplied, the deck is simply rotated by hand, but it can be mechanised or motorised

if desired using Meccano™ or similar components (see illustration right). The central pivot moulding incorporates a hole that is a force-fit for a Meccano™ axle or No.8 gauge wire.

Suitable for use with Universal (code 100) and Fine (code 75) track. Special adaptor plates are included in the kit to suit the different rail heights.

An essential and interesting addition for all OO/HO gauge layouts.

Comprehensive, fully illustrated instructions are included.



Close-up showing the accurately detailed deck and wheel mounting.

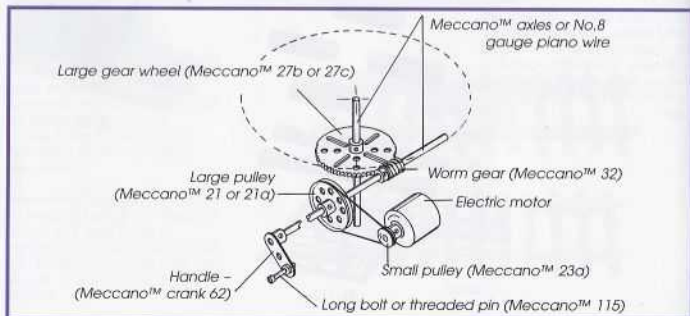

FINE TRACKAGE SYSTEM

With code 75 rail Peco Streamline Fine OO/HO track meets the demands of enthusiasts who wish to operate trains on scale height rail.

Since the clearance between the top of the rail and the rail fixings is only 1.346mm (.053in) it is important to understand that it can only be used with wheels having flange no greater than 1.143mm (.045in) in depth.

Many manufacturers currently produce locomotives and rolling stock with finer flanged wheels suitable for use with Peco Streamline Fine track. Flange depth however, is not the only consideration, back-to-back dimensions are also important and often vary. The advice is – test your rolling stock on a Fine turnout before deciding to use Fine trackage.

Easy connection to Universal
Fine trackage is readily connected to OO/HO Universal code 100 using the Dual type Joiners

SL-112 (see page 31).

The Fine range is being developed and added to regularly – watch the Railway Modeller every month for details.

FLEXIBLE TRACK

Fine OO/HO Streamline offers you the very best wooden sleeper type track, that has solid nickel silver rail.

Supplied in 914mm (36in) lengths.

WOODEN SLEEPER TYPE TRACK

With Nickel Silver Rail SL-100F

FINE TURNOUTS AND CROSSINGS

With code 75 rail

Available with electrofrogs only.* Peco Streamline Fine OO/HO turnouts' superb appearance adds the extra realism often sought by experienced enthusiasts.

**Except the single & double Slips and long & short crossings which are available in both Insulfrog and Electrofrog types.*

SMALL RADIUS TURNOUTS

Minimum space turnouts that are particularly useful in sidings and marshalling yards or indeed anywhere that space is restricted on the layout.

Nominal radius: 610mm (24in)

Angle: 12°

Length: 185mm (7³/₈in)

Small Rad. R/Hand, Electrofrog SL-E191
Small Rad. L/Hand, Electrofrog SL-E192

MEDIUM RADIUS TURNOUTS

The most popular radius and 'the happy medium' when space available and realism have both to be considered equally.

Nominal radius: 914mm (36in)

Angle: 12°

Length: 219mm (8⁵/₈in)

Med. Rad. R/Hand, Electrofrog SL-E195
Med. Rad. L/Hand, Electrofrog SL-E196



SL-100F



SL-E192



SL-E191



SL-E195



SL-E196

FINE TURNOUTS AND CROSSINGS

continued

With code 75 rail

LARGE RADIUS TURNOUTS

When space allows, these large radius turnouts have to be the first choice of the modeller looking for maximum realism regardless of space. They offer the greatest realism with their smooth gradual curve. Nominal radius: 1524mm (60in) Angle: 12° Length: 258mm (10¹/₂in) Large Rad. R/Hand, Electrofrog SL-E188 Large Rad. L/Hand, Electrofrog SL-E189

CURVED DOUBLE RADIUS TURNOUTS

Beautiful examples of the prototype in miniature. Curved turnouts overcome awkward situations and add interest to your layout. They are especially useful for forming crossovers on the approach to a station. In model form these are often on a curve. Nominal radii: Outside, 1524mm (60in) Inside, 762mm (30in) Length: 255mm (10¹/₂in) Curved D/Rad. R/H, Electrofrog SL-E186 Curved D/Rad. L/H, Electrofrog SL-E187

For Ballast Inlays see page 30.

SINGLE SLIP

With the introduction of this special turnout, your layout can be even more prototypically correct. Use it for the exit to a goods yard to avoid having a

facing turnout on a main running line - see instructional for further details.

Length and angles of the single slip match the long crossing. SL-194.

Angle: 12°

Length: 249mm (9¹³/₁₆in)

Single Slip, Insulfrog SL-180
Single Slip, Electrofrog SL-E180

DOUBLE SLIP

A masterpiece of OO/HO turnout production and invaluable on any layout since, it is in effect, the combination of four turnouts and a crossing all in one! It allows train movement in a variety of directions.

Length and angle of the double slip match the long crossing. SL-194.

Angle: 12°

Length: 249mm (9¹³/₁₆in)

Double Slip, Insulfrog SL-190
Double Slip, Electrofrog SL-E190

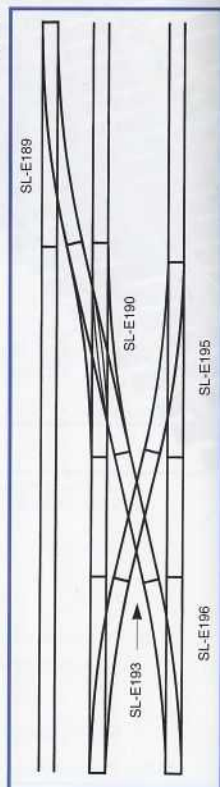
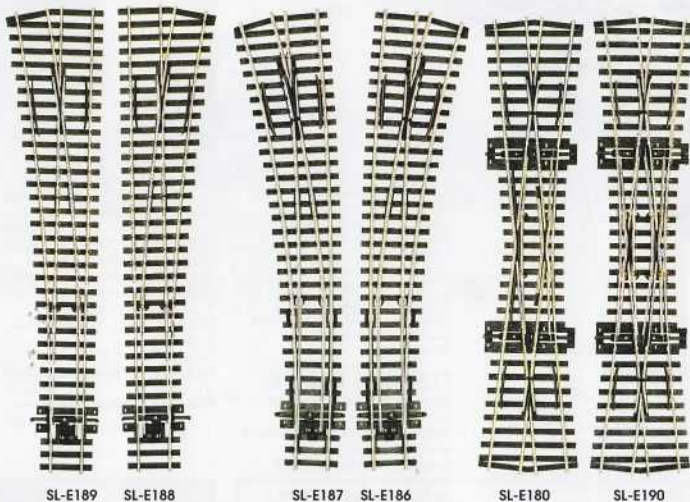

The illustration on right shows how the various radii of Peco Streamline OO/HO turnouts and crossings can be combined.

SMALL RADIUS Y TURNOUT

A very useful space saving turnout.
Nominal radius: 610mm (24in)
Angle: 24°
Length: 147.4mm (5¹³/₁₆in)
Small Radius Y, Electrofrog
SL-E197

LARGE RADIUS Y TURNOUT

Provides for long, sweeping Y junctions and other realistic formations.
Nominal radius: 1829mm (72in)
Angle: 12°
Length: 220mm (8²/₁₆in)
Large Radius Y, Electrofrog
SL-E198

LONG CROSSING

A useful item of trackwork for double junctions and other formations.
Angle: 12°
Length: 249mm (9¹³/₁₆in)
Long Crossing, Insulfrog
SL-194

Long Crossing, Electrofrog
SL-E194

SHORT CROSSING

Can be used to build scissors cross-overs and Y double junctions. A most useful space saver.
Angle: 24°
Length: 127mm (5in)
Short Crossing, Insulfrog
SL-193

Short Crossing, Electrofrog
SL-E193

For Ballast Inlays to fit SL-E197, SL-E198, SL-194 and SL-193, see page 30



SL-E197

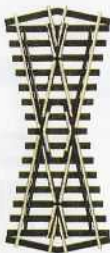

SL-E198

SL-E193
SL-193SL-E194
SL-194**FINE ACCESSORIES****TRACK FIXING PINS SL-14**

Blackened mild steel pins, 14mm (9/16in) long for fixing Peco Streamline.

METAL RAIL JOINERS, SL-110 code 75

For connecting rail ends together. Provides both mechanical and electrical bonding. Nickel silver.

DUAL RAIL JOINERS SL-112

For joining code 75 to code 100. Moulded in plastic with separate metal inserts, these joiners can be used either for insulation or where electrical continuity is required.

Special sleepers with a recess for the joiners are included in the pack to maintain correct spacing at joints.

INSULATING RAIL JOINERS Code 75 SL-111

Moulded in nylon for joining rail where an electrical break is required.

OO/HO BALLAST INLAYS

Fine and Universal use the same series of Ballast Inlays see page 30 for details.

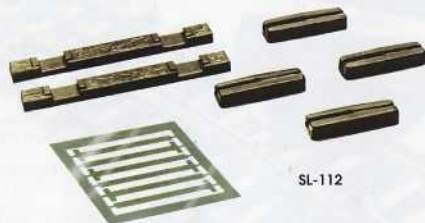

SL-112



SL-14



SL-110



SL-111



appearance, Streamline O gauge flat bottom track is ideally suited for use on garden layouts as well as indoors.

FINE TRACKAGE SYSTEM

With Flat Bottom code 143 rail The new Peco Streamline Flat Bottom O gauge trackage is something extra special. Superbly detailed, its 'wood grain' sleepers are the correct scale width and incorporate accurate scale Pandrol™ type rail fixings.

The solid nickel silver rail has been specially manufactured to precise, correct modern flat bottom section.

Despite its superb scale

FLEXIBLE TRACK WITH CODE 143 FLAT BOTTOM RAIL
Superbly detailed, this fine flexible track has realistic 'wood grain' sleepers and accurate Pandrol™ type rail fixings.

Supplied in 914mm (36in) lengths with solid nickel silver flat bottom rail. **SL-700FB**

FLAT BOTTOM RAIL TURNOUTS

Electrofrog only
Solid nickel silver flat bottom rail is used throughout including the frog sections and check rails.

Fitted with strong over-centre springs they are ready for hand use – there are no extra levers to buy.

The turnouts are self isolating and supplied ready-wired. The blades do not simply rely on contact with the stock rails, but are bonded electrically to them, providing for greater reliability when used out-of-doors. A special frog-rail polarity change-over switch is incorporated.

For remote control the Peco Lectrics Turnout Motor (PL-10) simply fits to the underside.

MEDIUM RADIUS TURNOUTS WITH CODE 143 FLAT BOTTOM RAIL
These are the basis for most formations.

The special frog-polarity switch incorporated ensures that only the track for which the blades are set is electrically alive.

Full instructions are supplied with each turnout.
Nominal radius: 1828mm(72in)
Angle: 8°
Length: 416mm (16½in)

Med. Radius R/H, Electrofrog **SL-E791FB**

Med. Radius L/H, Electrofrog **SL-E792FB**

For Turnout Motor, see page 50

ACCESSORIES

FIXING NAILS **ST-280**
Blackened mild steel nails for fixing track plus many other uses around the layout.

METAL RAIL JOINERS SL-710FB
Nickel silver, provide for both mechanical and electrical joins.
INSULATING RAIL JOINERS

Nylon. **SL-711FB**

COSMETIC FISHPLATES IL-717
Plastic fishplates for joining code 143 flat bottom rail to code 124 bullhead rail.

TURNOUT PARTS
Components for building flat bottom turnouts, see page 36



SL-700FB



SL-E791FB



SL-E792FB



SL-710FB

SL-711FB

FLAT BOTTOM TURNOUT PARTS

Components for enthusiasts who wish to build their own O gauge turnouts with flat bottom rail.

Moulded Wood Grain Sleeping

175mm (6⁷/₈in) lengths IL-714

Pandrol type Rail Fastenings

(code 143) IL-712

Slide Rail Baseplates

(code 143) IL-713

Frog, Wing & Check Rails

(code 143) IL-709

Turnout Blades

(code 143) IL-710

Rail, Flat Bottom, n/s

(code 143) IL-7FB

914mm (36in) lengths

Ballast PS-27

Natural light grey crushed stone, scaled for O gauge.



IL-712



IL-713



IL-710



IL-709



IL-7FB



IL-714



PS-27

FINE TRACKAGE SYSTEM

With Bullhead code 124 rail Peco Streamline O gauge bullhead trackage has set unsurpassed standards for 7mm scale realism.

Superbly detailed, its 'wood-grain' sleepers are the correct scale width and incorporate scale chairs with square headed 'fixing bolts' and 'wooden' keys.

Solid nickel silver bullhead rail is used throughout - including the turnout and crossing frog sections and check rails.

Despite its scale appearance, Streamline O gauge bullhead track is ideally suited for use on garden layouts as well as for indoor systems.

**FLEXIBLE TRACK WITH
CODE 124 BULLHEAD RAIL.**
Superbly detailed, Fine flexible bullhead track. Supplied in 914mm (36in) lengths with solid nickel silver bullhead rail.

**WOODEN SLEEPER TYPE
BULLHEAD TRACK SL-700BH**
With Nickel Silver Bullhead Rail.

BULLHEAD RAIL TURNOUTS AND CROSSING

With code 124 Bullhead rail Electrofrogs only
The bullhead series turnouts and crossing follow correct prototype practice.

Fitted with strong over-centre springs they are ready for hand use - no extra levers to buy.

For remote control the Peco Lectrics Turnout Motor (PL-10) simply fits to the underside.

BULLHEAD CATCH TURNOUTS

Used to protect main lines from run-away vehicles, they are situated mainly in exit roads from sidings and on inclines.

Length: 210mm (8¹/₄in)

Right Hand Catch Turnout

SL-784BH

Left Hand Catch Turnout

SL-785BH

See page 38 for Medium Radius Bullhead turnouts and crossing.



IL-700BH

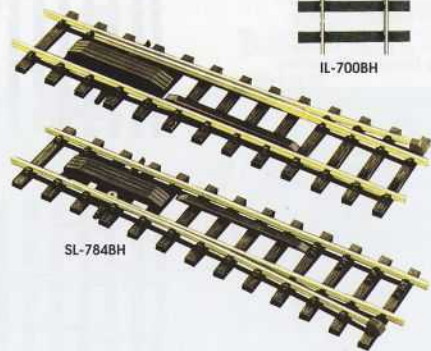

SL-784BH



MODERN IMAGE OR YESTERYEAR

Gone are the days when quaint little tank engines chuffed along a few miles of romantic branch line with the odd coach or two. Instead, we have modern main lines on which fast HST passenger and block freight trains pulled by massive diesel or electric locomotives speed through town and country. Yes, the modern scene is exciting – new stations, new signals, marshalling yards, in fact virtually complete new railways are being built, and

with the channel tunnel, continental trains can now run through to London.

If that is not enough, there is still steam operating on the many standard and narrow gauge lines run by preservation societies. There never was a time so full of interest for the railway modeller.

Although a start is often made with one of the excellent sets of ready made units, it can be a great deal more satisfying to design, build and operate in

true life-like manner a complete system of your own creation. This modern hobby, so often shared by parents and children, offers a wonderful challenge to one's ingenuity and creative ability – no wonder it has caught the interest and imagination of so many people from all walks of life.

Peco moves with the trends, and has been very largely responsible for developing N gauge especially in the trackwork field with the

traditional code 80 system and more recently with the finer looking yet robust code 55. Also, Peco has helped renew the interest in the larger standard gauges of O and 1 and lately the even larger narrow gauge scales, SM-32 and G-45.

Renowned world-wide for flexible and unit trackage systems in all the popular gauges, Peco also produces Wagons, Lineside and Scenic Kits, whilst Peco Publications publish the *Railway Modeller*,

and its companion magazine *Continental Modeller* plus many text books and booklets to ensure you enjoy your hobby to the full.

A study of this catalogue will, we hope, convince you that we strive to achieve perfection, give complete satisfaction and assist you to the utmost to ensure that you not only start on the right lines, but continue successfully. If we have left any doubt – we are at your service, always.

RIGHT A scene on Tan-y-coed in 009 by Steve and Angela Flay Photo: The Peco Studio.

CENTRE: Leaving the station at Hadley Road in 7mm scale. Photo: The Peco Studio.

LEFT N in a modern setting at Teignton Sands Photo: The Peco Studio.

BULLHEAD RAIL TURNOUTS AND CROSSING

continued

BULLHEAD MEDIUM RADIUS TURNOUTS

With code 124 Bullhead rail
The last word in O gauge
realism, they provide the basis
for many formations.

Nominal radius: 1828mm (72in)

Angle: 8°

Length: 416mm (16 3/8in)

Med. Radius R/H, Electrofrog
SL-E791BH

Med. Radius L/H, Electrofrog
SL-E792BH

BULLHEAD LONG CROSSING

With code 124 Bullhead rail
The angle matches the turnout
to provide for double junctions
and other formations.

Supplied packaged in two
halves which simply plug
together.

Angle: 8° Length: 584mm (23in)

Long Crossing, Electrofrog
SL-E794BH

MEDIUM RAD. BULLHEAD Y TURNOUT

With code 124 Bullhead rail
A valuable space saving turnout
that will add interest to many
track formations. Nominal
radius: 1828mm/72in

Angle: 8° Length: 381mm/15in

Med. Radius Y, Electrofrog
SL-E797BH

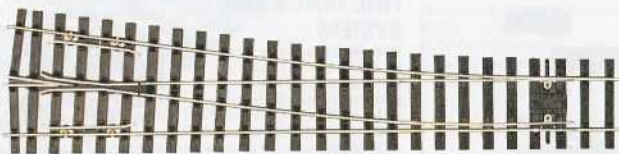

SL-E791BH



SL-E792BH

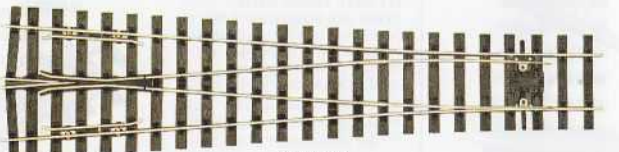

SL-E797BH

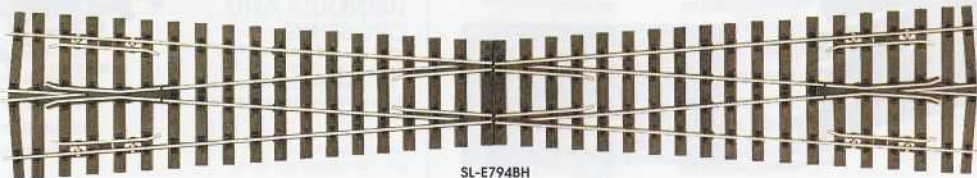

SL-E794BH

O TURNOUT AND CROSSING PLANS

Planning is often a difficult
procedure. By using these full
size templates you need not take
any chances. They are suitable
for both bullhead and flat
bottom series.

Printed ready to cut out, they
can be pinned onto your
baseboard whilst the required
formation is designed.

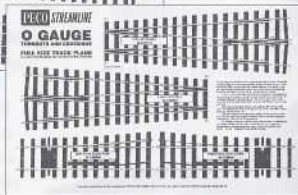
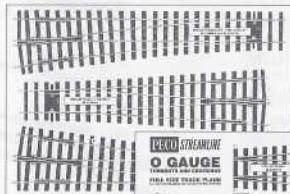

To obtain your free set of
plans, send a large SAE, together
with a label from a length of O
gauge Streamline track to:

Peco Technical Advice Bureau
Beer, Seaton, Devon, EX12 3NA,
England

BULLHEAD ACCESSORIES

FIXING NAILS ST-280
Blackened mild steel nails for fixing track. Approx. 10mm (.4in)
RAIL NAILS BRASS IL-11

Many uses, eg. soldered track construction. Approx. 10mm (.4in)
METAL RAIL JOINERS,

Nickel silver SL-10
INSULATING RAIL JOINERS,

Nylon SL-11
COSMETIC FISHPLATES IL-717
Plastic fishplates for joining code 124 bullhead rail to code 143 flat bottom rail.

RAIL-BUILT BUFFER STOP
SL-740BH

Super detailed plastic model of the standard British railways rail-built type.



ST-280



IL-11



SL-10



SL-11

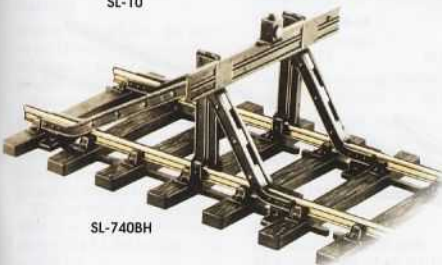

SL-740BH

BULLHEAD TURNOUT PARTS

Components with which to build O gauge bullhead turnouts and formations to match Peco Streamline.

Moulded Wood Grain Sleepers IL-714
175mm/6⁷/₈in lengths (20)

Running Rail Chairs IL-702
(approx. 100)

Slide Rail Chairs IL-703
(approx. 50)

Frog Rails and Wing Rails IL-706
Nickel silver (code 124) (1 Set)

Turnout Blades and Brackets
Nickel silver (code 124) (1 pair)
IL-708

Rail, Bullhead IL-7BH
N/silver (code 124),
914mm/36in lengths (6)

Rail, Bullhead IL-7SBH
Coated steel (code 124),
914mm/36in lengths (6)

BALLAST PS-27
Natural light grey crushed stone scaled for O gauge. Suitable for use both indoors and on garden layouts.

Use a well diluted PVA adhesive to hold the ballast in place.



IL-702

IL-703



IL-708



IL-706

IL-7BH
IL-7SBH

IL-714



A ready-made Streamline L/H turnout illustrated with flexible track.



UNIVERSAL FLEXIBLE TRACK

With code 200 rail

Truly impressive in appearance and embodying all the usual Streamline features – readily flexible, realistic 'wood grain' finish sleepers and accurately detailed rail fixings.

This robust standard gauge 1 track is ideal for use in the garden as well as on indoor layouts and for live steam or electric locomotives. The solid nickel silver rail ensures maximum strength and good electrical pick-up.

Can be used with Märklin™ and other gauge 1 systems.

WOODEN SLEEPER TYPE TRACK SL-800

Nickel Silver,
Supplied in 914mm/36in length.

METAL RAIL JOINERS SL-810

Nickel silver, for connecting rail ends together. Provides both mechanical and electrical bonding (24).



SL-800



SL-802



SL-803



SL-810



IL-8



SL-801

TURNOUT PARTS

Components for enthusiasts who wish to build their own turnouts and track formations to match Peco gauge 1 Streamline flexible track.

Moulded Wood Grain Sleeper SL-801

178mm/7in lengths (15)

Running Rail Fixings SL-802

(approx. 100)

Slide Rail Fixings SL-803

(approx. 50)

Frog and Wing Rails SL-806

code 200 nickel silver (1 set)

Turnout Blades SL-808

code 200 nickel silver (1 pair)

Flat Bottom Rail, IL-8

n/s code 200 914mm/36in

lengths (6)



SL-808



SL-806



4mm FINE TRACK COMPONENTS

WOODEN TYPE SLEEPERS,
RAIL FIXINGS AND FLAT
BOTTOM RAIL
FOR 16.5, 18.2 AND 18.83
GAUGES

Superb components with which to build your own fine track and turnouts to any of the above gauges.

Pandrol™ clips are now the most widely used flat bottom rail fixings on British Rail and Peco have faithfully reproduced them in 4mm scale, even to including the Lockspike™ detail.

The rail fixings are a precise slide fit onto the solid nickel silver code 82 flat bottom profile rail.

Assembly onto the moulded sleepers or turnout timbers is simple using the special

Peco 3-way Track Gauge (IL-116) and a liquid styrene solvent.

Wood type Sleepers,
Brown moulded plastic
(approx.96) 33.5mm x 3.5mm
IL-111

Pandrol-type Rail Fixings
(approx.200) IL-112

Slide Rail Fixings
(approx.42) IL-113

Turnout Sleeper/Timbers
(32) 88mm x 4mm IL-114

Flat Bottom Rail, code 82
Nickel silver, 914mm/36in
lengths. (6) IL-115

CONCRETE TYPE SLEEPER
UNITS, IL-121

**RAIL FIXINGS AND
FLAT BOTTOM RAIL FOR
16.5, 18.2 AND 18.83 GAUGES**
Moulded in realistic concrete
colour plastic, the rigid six-
sleeper units enable straight

track to be accurately and easily laid. For building curved track, the sleeper joining webs need cutting on one side.

The separate rail fixings are moulded in brown plastic and are a precise slide fit onto the code 82 flat bottom rail (IL-115).

Assembly onto the moulded sleeper units is simple using the special Peco 3-way Track Gauge (IL-116) and a liquid styrene solvent.

Concrete type Sleeper units
with separately moulded rail
fixings (approx.96) 32mm x
3.5mm(at bottom)3mm(at top)

TRACK GAUGE IL-116
Stainless steel For 16.5, 18.2
and 18.83 gauges

Use this special Peco 3-way
Track Gauge for easy yet accurate
assembly of the Individulay
track components.

CONDUCTOR RAIL CHAIRS IL-120

Simple to install, these accurately detailed, unbreakable plastic mouldings are a slide fit onto Peco code 60 rail, (IL-1).

Designed for use with Streamline and Setrack, they are nevertheless suitable for use with the 4mm Individulay

system and other makes of track.

A separate packing washer/baseplate is included to allow for different heights of rail.

Ideal for Southern Railway outside third systems and London Underground layouts (use them for the centre rail also). (approx.200)

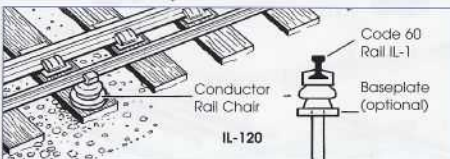

CONDUCTOR RAIL IL-1

Special section, code 60 flat bottom nickel silver rail for use with the Conductor Rail Chairs (IL-120). 610mm/24in lengths (6).



Outside third (eg. SR) and centre (eg. LT) conductor rails added to OO/HO Streamline using IL-120 and IL-1.



TURNOUT PARTS

Separate components with which to build turnouts and special formations to your own design to match Peco Streamline.

O GAUGE**FLAT BOTTOM****Moulded Wood Grain****Sleeping**

175mm/6⁷/₁₆in lengths (20)

Pandrol™ Type Rail Fastenings (100) IL-714
IL-712

Slide Rail Baseplates (approx. 48) IL-713

Frog, Wing and Check Rails code 143 (1 set) IL-709

Turnout Blades code 143 (pair) IL-710

Rail, Flat Bottom, N/Silver code 143 914mm/36in lengths (6) IL-7FB

BULLHEAD**Moulded Wood Grain****Sleeping**

175mm/6⁷/₁₆in lengths (20)

Running Rail Chairs (100) IL-702

Slide Rail-Chairs (50) IL-703

Frog & Wing Rails code 124 (1 set) IL-706

Turnout Blades & Brackets IL-708
Nickel silver, code 124 (pair)

Rail, Bullhead, IL-7BH
N/silver code 124, 914mm/36in lengths (6)

Rail, Bullhead, IL-7SBH
Coated steel code 124, 914mm/36in (6)

**O-16.5****Moulded Wood Grain****Sleeping**

SL-501
Can be used for converting OO/HO Sctrack and Streamline Turnouts and Crossings for use with O-16.5, see illustration on page 46.

124mm/4⁷/₁₆in lengths (6) IL-13

Spikes, blackened steel (28gm/1oz.)

Rail, Flat Bottom, n/s code 100 914 mm/36in lengths (6) IL-5



SL-501



IL-13



IL-5

GAUGE 1 & SM-32**Moulded Wood Grain****Sleeping**

SL-801

178mm/7in lengths (15)

Running Rail Fixings (approx. 100) SL-802

Slide Rail Fixings (approx. 50) SL-803

Frog & Wing Rails code 200 (1 set) SL-806

Turnout Blades code 200 (pair) SL-808

Rail, Flat Bottom, n/s code 200 914mm/36in lengths (6) IL-8



SL-801



IL-8



SL-808



SL-806

RAIL, FLAT BOTTOM SECTION AND BULLHEAD SECTION

Correct section Rail to prototype profile in nickel silver, coated steel and aluminium.

Genuine Peco Rail is only supplied in wrapped bundles for protection.

Dimensions listed refer to the rail-section diagrams below

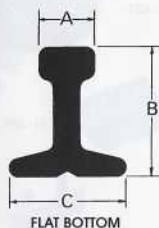

FLAT BOTTOM



BULLHEAD

BULLHEAD RAIL

Code 124, nickel silver rail IL-7BH

Matches O Streamline Bullhead
A = 1.52mm (.060in)
B = 3.15mm (.124in)
C = 1.85mm (.073in) (6)
Code 124, bright coated steel rail (6) IL-7SBH

Code 200, nickel silver rail IL-8

Matches gauge 1 Streamline and SM-32 Streamline.
A = 2.46mm (.097in)
B = 5.08mm (.200in)
C = 2.87mm (.113in) (6)

FLAT BOTTOM RAIL

Code 60, nickel silver rail IL-1
Matches Z gauge Streamline and also suitable for 4mm scale conductor rail.

A = 0.76mm (.030in)
B = 1.57mm (.062in)
C = 1.24mm (.049in) (6)

Code 75, nickel silver rail IL-3

Matches OO/HO Streamline Fine.
A = 0.78mm (.031in)
B = 1.90mm (.075in)
C = 1.72mm (.068in) (6)

Code 80, nickel silver rail IL-4

Matches N Streamline Universal.
A = 0.63mm (.025in)
B = 2.03mm (.080in)
C = 1.39mm (.055in) (6)

Code 82, nickel silver rail IL-115

For 4mm scale Individulay.
A = 0.89mm (.035in)
B = 2.08mm (.082in)
C = 1.77mm (.070in) (6)
Code 100, nickel silver rail IL-5

Matches OO/HO Setrack, OO/HO Streamline Universal

and O-16.5 Streamline.
A = 1.04mm (.041in)
B = 2.5mm (.100in)
C = 2.28mm (.090in) (6)

Code 100, bright coated steel rail (6) IL-5S

Code 143, nickel silver rail IL-7FB

Matches O Streamline Flat Bottom
A = 1.60mm (.063in)
B = 3.63mm (.143in)
C = 3.20mm (.126in) (6)

Code 250, nickel silver rail IL-9

Matches G-45 Streamline. (6)

Code 250, aluminium rail IL-9A

A = 2.79mm (.110in)
B = 6.35mm (.250in)
C = 4.06mm (.160in) (6)

O-16.5 narrow gauge Sleeper, for converting OO/HO Setrack and Streamline Turnouts and Crossings for use with O-16.5, is on page 42.

O gauge Sleeper, Running Rail Chairs, Slide Rail Chairs, Frog rails and Turnout Blades for O Gauge Flat Bottom and Bullhead are on page 42.

Gauge 1 and SM-32 Sleeper, Rail Fixings, Slide Rail Fixings, Frog Rails and Turnout Blades for Gauge 1 and SM-32 (narrow gauge) are on page 42.

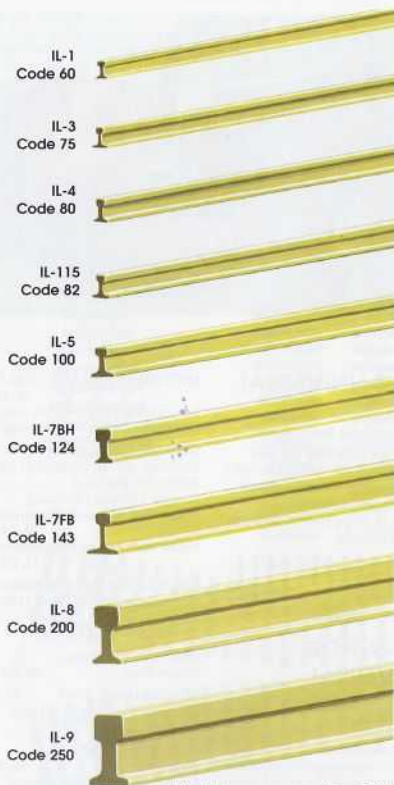

Illustrations are approx. twice full size.

RAIL FIXINGS

Rail Nails, brass IL-11
Many uses, eg. soldered track construction. (approx. 500)

Spikes, for fixing rail IL-13
Square section non-turning. (28gm/1oz)



FISHPLATES

Fishplates for flat bottom rail IL-20
Scale length, nickel silver. (25)

Fishplates for bullhead rail IL-21
Scale length, nickel silver. (25)



Loco No.3 Sir Hayden shunting at Pendre yard, Talylyn Railway, Photo: John Macdougall



N-6.5 UNIVERSAL TRACK

With code 60 rail
For N scale narrow gauge (2mm scale on 6.5mm gauge) use Peco Streamline Z gauge track SL-200 (see also page 13). Supplied in 609mm (24in) lengths



SL-200

OO-9/HOe UNIVERSAL TRACKAGE SYSTEM

With code 80 rail
For narrow gauge models built to OO (4mm scale) or HO (3.5mm scale) running on 9mm gauge.

UNIVERSAL FLEXIBLE TRACK

SL-400
Wooden sleeper type with nickel silver rail, 914mm (36in) lengths.

SMALL RADIUS TURNOUTS

Nominal radius: 304mm (12in)
Angle: 19 1/2°
Length: 125mm (4 1/2in)
Small Rad. R/hand, Electrofrog: SL-E491
Small Rad. L/hand, Electrofrog: SL-E492

MEDIUM RADIUS Y TURNOUT

Nominal radius: 457mm (18in)
Angle: 22 1/2°
Length: 109mm (4 1/2in)
Med. Rad.Y Turnout, Electrofrog: SL-E497

TRACK FIXING PINS SL-14
Blackened mild steel, 14mm (9/16in) long.

METAL RAIL JOINERS, code 80 SL-310
For mechanical and electrical bonding.

INSULATING RAIL JOINERS Code 80, moulded in Nylon SL311

MANUAL DECOUPLER SL-430
For use with Peco narrow gauge coupling (GR-101, see page 67) and similar types.

SLEEPER BUILT, NARROW GAUGE TYPE BUFFER STOP
Simulated wood grained buffer stop. SL-440

WAGON TURNTABLES-L-427
Finely detailed plastic moulding.

TURNOUT LEVER (Dummy) Non-working. SL-428
Finely detailed moulding.



SL-14



SL-310

SL-311



SL-427



SL-400



SL-E491



SL-E492



SL-E497



SL-428



SL-440



SL-430

INTRODUCTION

Peco produces a range of narrow gauge tracks that covers all the popular scales in use today. Although the gauges coincide with the standard gauges the sleepers and their spacing are completely different*

*Except N-6.5 which uses Z Track
N-6.5 Streamline.....44
OO-9/HOe Streamline.....44
HOmStreamline.....45
O-16.5 Streamline.....46
SM-32 Streamline.....47
G-45 Setrack & Streamline...48

HOM UNIVERSAL TRACKAGE SYSTEM

With code 75 rail
Peco fine HOM track follows the same strict specifications as all our other code 75 track.

UNIVERSAL FLEXIBLE TRACK

SL-1400
Wooden sleeper type with nickel silver rail. 914mm (36in) lengths.

TURNOUTS

Highly detailed and a true representation of the prototype. Nominal radius: 508mm (20in)

Angle: 10°
Length: 160mm (6⁷/₁₆in)

Med. Radius R/hand Electrofrog **SL-E1495**

Med. Radius L/hand Electrofrog **SL-E1496**

Curved R/Hand Electrofrog **SL-E1486**

Curved L/Hand Electrofrog **SL-E1487**

Inner Radius 457mm (18in)

Outer Radius 609mm (24in)

Length: 237mm (9³/₁₆in)

All turnouts include dummy lever and extension sleepers.

DIAMOND CROSSING

Angle: 20° **SL-E1493**

Length: 117mm (4⁵/₁₆in)

TRACK FIXING PINS **SL-14**

Blackened mild steel, 14mm (9¹/₁₆in) long.

METAL RAIL JOINERS, code 75

For mechanical **SL-110**

and electrical bonding.

INSULATING RAIL JOINERS

Code 75, **SL-111**

moulded in Nylon

BUFFER STOP RAIL TYPE

Simulated wood **SL-1440**

grained buffer stop.

BUFFER STOP STEEL BOX TYPE

SL-1441

widely used for the scenic mountain routes in Switzerland but is also common for minor lines in other parts of Europe, notably Germany, France, and Portugal.

Colonial lines in East Africa, India, South East Asia, and parts of South America were also built to metre gauge.

In 3.5mm scale this 12mm gauge track will also conveniently represent (as HO_N3¹/₂) the 3'6" track used in many other parts of the world: most of southern Africa;

Australia (Queensland, South Australia, and Tasmania); Japan; Norway; and parts of South America.

If working in 4mm scale, 12mm gauge is exactly right (as O_N3) for the many 3' gauge lines in Ireland, the Isle of Man, and the rare English examples such as the Southwold and the Rye & Camber.

Modelling in TT gauge is also quite popular and this track has been adopted by many enthusiasts working in this scale. Open up new horizons in modelling with this fine new track from Peco.

TRACK PLANS

To obtain a full set of plans send a large SAE together with a label from a length of HOM Streamline Track to: Peco Technical Advice Bureau Beer, Seaton, Devon, EX12 3NA, England



SL-1400



SL-1440



SL-1441



SL-110

SL-111



SL-E1493

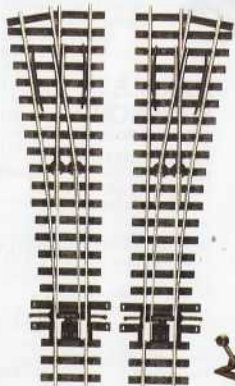

SL-E1496

SL-E1495



SL-14



SL-E1486



SL-E1487

INTRODUCTION

Once again Peco lead the way in giving enthusiasts even more choice of possible prototypes to model with a new trackage system of the same outstanding quality and detail as other established Streamline products. Recognising the popularity of the Swiss metre gauge, a brand new HOM (12mm gauge) track has been developed, based on extensive research and official track design drawings. Metre gauge is not only still

FLEXIBLE TRACK & TURNOUTS

with code 100 rail

WOODEN SLEEPER TYPE TRACK SL-500Nickel silver rail.
Supplied in 914mm (36in)
lengths.**MEDIUM RADIUS TURNOUTS**
Nominal radius: 610mm (24in)
Angle: 12°
Length: 185mm (7³/₃₂in)
Medium Rad. R/Hand,
Electrofrog SL-E595**Medium Rad. L/Hand,
Electrofrog** SL-E596**Y TURNOUT**
Nominal radius: 914mm (36in)
Angle: 22° Length: 197mm
(7⁷/₁₆in)
Y Turnout, Electrofrog SL-E597

SL-500



SL-E595

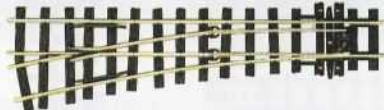

SL-E596



SL-E597

UNIVERSAL TRACKAGE SYSTEMWith code 100 rail
For narrow gauge models built to O (7mm) scale and running on 16.5mm gauge track.

This increasingly popular scale allows for a combination of maximum detail and interest in a relatively small space.

ACCESSORIES**RAIL, CODE 100 NICKEL SILVER** IL-5**TRACK FIXING PINS** SL-14
Blacked mild steel pins, 14mm (9/16in) long. For fixing Peco Streamline to wood fibre (Sundeala™) or similar baseboard surfaces.**METAL RAIL JOINERS**, code 100 SL-10Provides both mechanical and electrical bonding.
INSULATING RAIL JOINERS Code 100, moulded in Nylon, SL-11**O-16.5 SLEEPERING** SL-501
Additional types of turnouts and crossings can be made for use with O-16.5 by using OO/HO Setrack and Streamline turnouts and replacing some of the timbers (sleepers) with this special moulded plastic sleeperring. See photograph.**RAIL FIXINGS****Rail Nails, brass** IL-11
Many uses, for example, soldered track construction.
Spikes, for fixing rail IL-13
Square section non-turning.

SL-14



SL-10



SL-11



IL-13



IL-5



IL-11

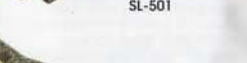

IL-13

*Converted OO/HO Setrack crossing for use with O-16.5 using the special sleeperring SL-501.*

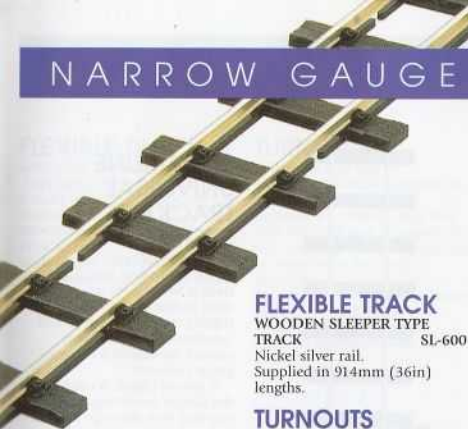

FLEXIBLE TRACK

WOODEN SLEEPER TYPE TRACK SL-600
Nickel silver rail.
Supplied in 914mm (36in) lengths.

TURNOUTS

Medium Radius R/H SL-E695
Medium Radius L/H SL-E696
Nominal radius: 1524mm(60in)
Angle: 8° Length: 510mm (20 1/8in)
Medium radius Y SL-E 697
Nominal radius: 2413mm(95in)
Angle: 8° Length: 487mm(19 1/2in)
All are fitted with over-centre spring, and are ready for immediate use by hand (no extra levers or switches to buy). For remote control the Peco Lectrics Turnout Motor PL-10 simply clips on underneath. Nickel silver rail.



SL-600



SL-E697



SL-E696

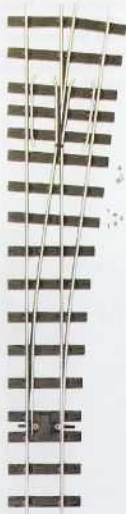

SL-E695

WAGON TURNTABLE KIT

This kit features injection moulded components with code 200 Nickel Silver rail parts all of which are beautifully machined to size and fully finished, making accurate assembly easy.
Wagon Turntable kit SL-627

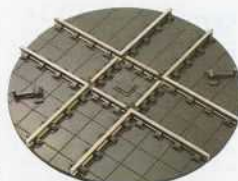

SL-627

TURNOUT PARTS

Components for enthusiasts who wish to build their own SM-32 turnouts and formations.

Moulded Wood Grain Sleeper SL-801
178mm (7in) lengths
Running Rail Fixings SL-802
Slide Rail Fixings SL-803
Frog & Wing Rails, code 200 n/s SL-806
Turnout Blades, code 200 n/s SL-808
Flat Bottom Rail, code 200 Nickel silver, 914mm (36in) lengths IL-8
Metal Rail Joiners, nickel silver SL-810

For connecting rail ends together. Provide both mechanical and electrical bonding.

Medium Radius Y, Electrofrog SL-E697

TURNOUT TEMPLATES

Full size printed template sheets on which to assemble turnouts using the parts shown on this page.

Available direct from Peco, please write or telephone for details.

Right Hand Turnout Template SM-T1

Left Hand Turnout Template SM-T2

Nominal radius: 1016mm(40in)
Angle: 12°
Length: 463mm (18 1/4in)



SL-810



SL-803



SL-802



IL-8



SL-801



SL-808



SL-806

SETRACK RIGID UNIT TRACK

With code 250 rail

A High quality unit trackage for building realistic layouts quickly and easily. Carefully designed to match (and connect with) Streamline G-45, the units have authentic slightly irregular sleepering with wood grain effect and detailed rail fixings.

Suitable for use with most makes of G-45 trains. Each unit is complete with rail joiners whilst special joiners (SL-912) are available for joining to tracks with larger rail sections - see page 49.

*Locomotives No.6 Douglas and No.2 Dolgach at Abergynolwyn on the Talyllyn Railway.
Photo: John Macdougall.*

WOODEN SLEEPER TYPE

Supplied in straight and curved units with code 250 nickel silver rail.

Standard Straight ST-902

Length: 300mm (11^{13/16}in)

Standard Curve ST-905

This small radius unit can be particularly useful in conjunction with G-45 Streamline - eliminating the need to curve the flexible track to this radius. 600mm (23^{3/8}in) radius 30° angle 12 per circle

STREAMLINE UNIVERSAL TRACKAGE SYSTEM

With code 250 rail

This most true to scale looking track is suitable for use with most makes of G-45 trains. The slightly irregularly spaced and 'weathered' finish sleepers capture the essential narrow gauge character.

A special plastic is used for the sleeper mouldings and together with the code 250 rail makes a strong, yet readily flexible track that will withstand the heavy weight of locomotives in this size. It can be used indoors or on garden layouts using live steam or electric locos.

Peco G-45 turnouts are carefully matched with the track and as completely self contained units, they require no extra levers for hand operation. For remote control use Mounting Plate PL-8 in conjunction with the LCB™ turnout motor (see page 49).

The turnout blades are machined to correct prototype profile from solid nickel silver rail whilst the insulated frog is moulded in a special hard wearing plastic.

Unlike other Peco Insulfrog turnouts they are not electrically self-switching - all rails are 'live' whichever direction the blades are set for.



ST-902



ST-905

FLEXIBLE TRACK

With code 250 rail
Supplied in 914mm (36in)
lengths with nickel silver or
aluminium rail.

WOODEN SLEEPER TYPE TRACK

With nickel silver rail SL-900
With aluminium rail SL-900A



SL-900

TURNOUTS

with code 250 rail
MEDIUM RADIUS TURNOUTS
These really superb G-45
turnouts are carefully matched
with the track and as completely
self contained units, they require
no extra levers for hand
operation.

For remote control use mounting
plate PL-8 (see below).

The turnout blades are
precisely machined from solid



SL-995

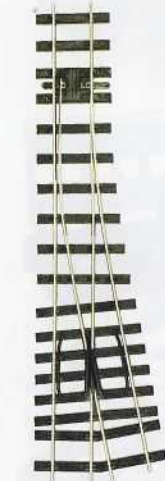

SL-996

nickel silver rail whilst the
insulated frog is moulded in a
special hard wearing plastic.

Unlike other Peco Insulfrog
turnouts they are not electrically
self-switching - all rails remain
'live' whichever direction the
blades are set for.

Nominal radius: 1219mm(48in)
Angle: 12°
Length: 600mm (23½in)
Medium Radius, R/Hand, SL-995
Insulfrog Medium Radius, L/Hand, SL-996
Insulfrog

ACCESSORIES

METAL RAIL JOINERS SL-910
Nickel silver, for joining code
250 G-45 Streamline track and
turnouts.

Also required when joining
Setrack units to Streamline.

INSULATING RAIL JOINERS SL-911
Moulded in plastic for joining
rail where an electrical break is
required.

DUAL RAIL JOINERS SL-912
Moulded plastic joiner (with
metal insert), for joining Peco
code 250 to larger section rail.
The metal insert can be omitted
when insulation is required.

The moulding incorporates a
central 'web' to prevent the rail
ends touching.

BUFFER STOP SLEEPER BUILT TYPE SL-940
The all important item to
complete the end of a siding.
Modelled to typical narrow
gauge practice, it is supplied in
kit form moulded in hard
brown plastic and fits onto both
G-45 Setrack and Streamline.
Simple assembly.

MOUNTING PLATE PL-8
This has been developed
specifically as a universal mount
for the LGB® motor so that it
can be fitted to Peco turnouts.
Full instructions are included.

RAIL
Supplied in 914mm (36in)
lengths
Code 250, nickel silver rail IL-9
Code 250, aluminium rail IL-9A



SL-910



SL-911



SL-912



IL-9



PL-8



SL-940

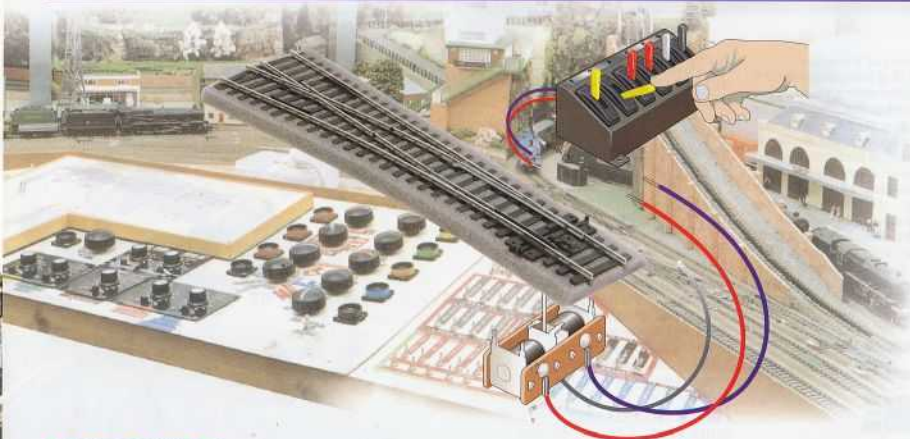

TAKE CONTROL - WITH PECO LECTRICS

There is a small and comprehensive range of electrical items within the Peco LECTRICS range. The all essential Point Motor, Operating Switches, simple On/Off Switches, Wheel Cleaning Brush & Scrapers plus a host of other interesting items.

TURNOUT MOTORS

At first you may well be satisfied with switching the turnouts by hand. Both Peco Setrack and Streamline turnouts allow you to do this, incorporating as they do, over-centre springs that hold



the blades in the position set.

Eventually, as your layout and experience grow, the need to operate turnouts by remote control will become apparent. Apart from the practical aspect of not always being able to reach every turnout, it is much more fun to operate them in a more railway-like manner.

STANDARD MOTOR PL-10

This is the most famous type of Turnout Motor since it has been in production for well over thirty years and many thousands of enthusiasts have been using it successfully over this period of time. There is no need for ugly boxes on the side of turnouts for this motor simply clips

underneath, converting it immediately for electrical operation. With no linkage or other connections it provides positive action and is completely invisible in use. A hole in the baseboard is necessary to accept the motor, then lay the turnout with the motor already attached. It is

operated using the 16 volts AC outlet on your controller (2amps required) via one of our famous passing contact switches ref. PL-26. Full instructions included.

MOTOR WITH EXTENDED OPERATING PIN PL-10E

Use this method if you do not wish to cut a large hole in your baseboard. Drill a small hole, only 9.5mm ($\frac{3}{8}$ in) through the baseboard at the position of the tie bar. Full instructions are given on how best to instal this motor using the special mounting plate PL-9. The motor requires 16 volts AC at 2 amps to operate correctly and should be controlled via one of our passing contact switches ref. PL-26.

MOTOR FOR LOW AMPERAGE APPLICATIONS PL-10W

Some transformer controllers, especially those manufactured in other European countries, work using a smaller amount of amps. This motor has been especially designed to suit these applications.



Showing the use of PL-12 in above the baseboard application.



The Accessory Switch PL-13, or Microswitch PL-15 can be fitted to, and operated by the Turnout Motor for controlling frog polarity etc. The motor is best fitted directly to the underside of Peco Turnouts, but can also be fitted as shown in figs. 1 and 2.

Fig.1 For below baseboard mounting use PL-10E in conjunction with mounting plate PL-9

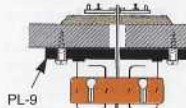

Attach motor to mounting plate PL-9 then screw assembly to underside of baseboard

Fig.2 Using the Turnout Motor with other makes of turnout that do not have self-locking tie-bars.

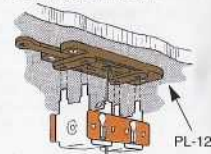

Insert motor tags into Adaptor PL-12 and bend legs over before screwing assembly to underside of baseboard

MOTOR ADAPTOR BASE PL-12
If above baseboard fitting is essential (e.g. to avoid baseboard framework), the Peco Turnout Motor can be mounted either side of the turnout using this Adaptor Base. It can then be conveniently disguised, on OO/HO layouts by covering with a Platelayer's Hut LK-4 (see page 80), or some other structure. An Extension Arm is also included.

MOUNTING PLATE PL-9
This base unit is used for those modellers who do not wish to attach their motors directly to their turnouts. The motor with the extended pin ref. PL-10E is simply attached to the mounting plate which in turn is secured under the baseboard. Full instructions and screws included.

MOTOR ADAPTOR BASE PL-8
For G-45
This has been developed specifically as a universal mount for the LGB™ motor so that it can be fitted to Peco turnouts. Full instructions are included.



PL-12



PL-9



PL-8

SWITCHES

Our new range of switches to give you even more control on your model railway. All the switches are designed to fit into the same switch console and can be ganged together.

SINGLE POLE ON-OFF PL-22
Use this switch for controlling isolated sections of track such as those found in locomotive depots, bay platforms etc. or to operate street lights and motorised scene accessories.

SINGLE POLE CHANGEOVER ON-ON SWITCH PL-23
Use this switch to control colour light signalling or use two ganged together as a polarity reversing switch to control return loops, turntables etc.

PASSING CONTACT SWITCH PL-26
This switch provides the short burst of current needed to operate the popular PL-10 Turnout Motor. May be ganged using the Joining Bar PL-24 with either of the other two types to provide signal interlocking, panel lights etc. A choice of four lever colours is available.

Red Lever PL-26R
Yellow Lever PL-26Y
Black Lever PL-26B
White Lever PL-26W

SWITCH CONSOLE PL-27
Provides a convenient six-bay panel which can be expanded as required.

MOUNTING PLATE PL-28
For modellers who prefer to mount their switches into a 'mimic' diagram or wish to update an existing panel.

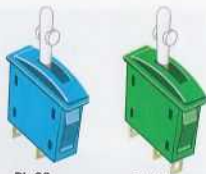

PL-22

PL-23



PL-26



PL-27



PL-28



PL-24

JOINING BAR PL-24
Allows switches to be ganged together and operate simultaneously

ACCESSORY SWITCH PL-13
For fitting to Turnout Motor

One of these simple, inexpensive switches can be easily fitted underneath the Turnout Motor (PL-10) to provide electrical switching for frog polarity, signals etc. Suitable for all turnouts with the exception of N gauge Single and Double Slips

TWIN MICROSWITCH KIT PL-15
For fitting to Turnout Motor

This easy to assemble unit provides two sets of switched contacts that can be used to control the polarity of live frogs whilst simultaneously operating panel indicator lights, see fig.3.

Other uses include signal interlocking and reversing-loop switching, see fig.4.

Complete with illustrated instructions.

4-POLE DOUBLE THROW SWITCH PL-21

This special on/on, panel-mounting, 12-tag toggle switch is required when using the N Scissors Crossover (SL-E383E; see page 20). A most useful item with many applications around the layout.

TRACK ISOLATING SWITCH PL-20

Can be clipped onto Peco Streamline OO/HO track to bridge isolating gaps, or used as an on/off switch on control panels.
Easy action. In plastic case.



PL-13



PL-15



PL-21



PL-20

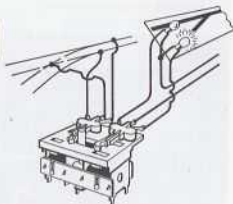

Fig.3 Using the Microswitch to control the polarity of a live frog whilst also operating the panel indicator lights.

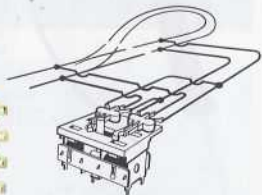

Fig.4 Using the Microswitch for polarity changeover on a reversing loop.

PROBE, STUDS & TAG WASHERS

For turnout motor operation, etc. A simple yet effective method. Studs inserted in track plan panel are wired to the motors which are then operated by touching the studs with the probe along the route.

Probe PL-17
With plastic handle and silver plated pin.
Studs and Tag Washers PL-18
Silver plated



PL-17



PL-18



PL-30

RAIL CLEANER PL-41

An abrasive rubber block for burnishing the rail surfaces. Ensures good electrical contact.



PL-41

GRAIN OF WHEAT BULBS

These miniature bulbs have many uses, particularly in colour light signals, coach interiors, loco and brake van lights, etc.

They are also suitable for use outside the railway boundary, for street lights, for model buildings (both for interior illumination and shop signs).

Consumption: Approx. 45mA @ 12v DC.

- Grain of Wheat Bulb, Red PL-30R
- Grain of Wheat Bulb, Yellow PL-30Y
- Grain of Wheat Bulb, Green PL-30G
- Grain of Wheat Bulb, Clear PL-30C

ELECTROLUBE PL-64

Pick-up troubles and other electrical problems can be solved with Peco Electrolube, lubricant/cleaner.

It can be used with most plastics and is ideal for lubricating motors, commutators and bearings. Supplied with fine tube for access to awkward mechanisms.



PL-64

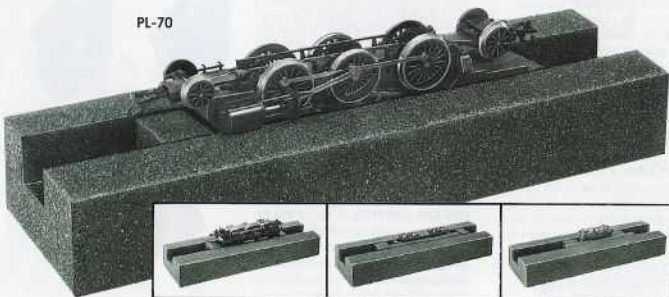

PL-70



OO/HO

N

OO-9

LOCOMOTIVE SERVICING CRADLE

PL-70

For N, OO/HO and OO-9 An extremely useful accessory which enables locomotives and rolling stock to be held firmly without damage during servicing. Made in soft foam plastic, it will not harm livery or fine detailing whilst wheel cleaning and lubrication etc. are carried out.

The channel in the base moulding fits all OO/HO items and an extra foam strip insert provides for N and OO-9 gauge. Length: 254mm (10in)



PL-40

WHEEL CLEANING BRUSH AND SCRAPER PL-40

Essential for cleaning locomotive driving wheels to ensure efficient running. Simply connect the wires from the Brush and Scraper either direct to a 12volt DC power

unit, or to each rail of the track and apply the Brush and Scraper to the driving wheels, one each side.

Used in conjunction with the Servicing Cradle (PL-70), they will help keep your locomotives in tip-top working order.



Whether your interest lies in the railways of yesteryear, when the variety of goods stock used seemed endless, or in today's modern systems with their bulk freight trains of long wheelbase fitted stock, there is endless pleasure shunting or marshalling the goods trains on your layout.

Peco produce modern and old-time wagons in N and O scale plus a series of OO/HO tank wagons.

N QUALITY LINE WAGONS

Supplied completely assembled, painted and ready-to-run, this superb series of wagons sets the standard by which all N wagons are measured. The fine detail and finish – painted and lettered in correct liveries, has made them 'collectable' items, yet their immaculate appearance is fully

matched by their free-running, allowing really long trains to be hauled with ease.

The range includes both 10ft and 15ft types and covers Private Owner, Railway Company (big four) and modern wagons and vans.

All the ready-to-run are available in kit form as well as three different types of 9ft. wheelbase mineral wagons, plus chassis, wheels couplings etc. separately.

OO/HO WONDERFUL WAGON KITS

Introduced in 1954, Peco Wonderful Wagons have long been famous for their pioneering design. Actual working axle-box springs and sprung buffers were just two of the features that set them apart as leaders right from

the start.

Today, all the famous original features are still incorporated together with many additional improvements made possible by modern production methods.

For the scratch-builder, components from the kits are available separately.

O WONDERFUL WAGON KITS

Designed to satisfy even the most discerning modeller in 7mm scale, Peco O gauge Wonderful Wagons include super-detailed injection-moulded components, metal tyre wheels and pin-point axles with brass bearings.

Sprung buffers and 3-link couplings are also featured whilst the modern BR series have actual working axle-box springs, 3-hole disc wheels and movable



brake levers.

Some components are also available separately for use when building your own wagons. (See page 65)

*RIGHT: Restored private-owner and railway company wagons on show at Didcot Railway Centre.
Photo: John Macdougall.*

*LEFT: A busy goods yard scene on the Seaton Junction layout at Pecorama.
Photo: Peco Studio.*

STANDARD GAUGE WAGON AND ACCESSORIES INDEX

N Quality Line Wagons (ready-to-run)	54
N Quality Line Kits	58
N Quality Line Wagon Accessories	59
N Wagon Loads and Containers	60
OO/HO Wonderful Wagon Kits	61
OO/HO Container Kits	62
OO/HO Printed Wagon Cards	61
OO/HO Wonderful Wagon Accessories	63
O Wonderful Wagon Kits	64
O Wonderful Wagon Accessories	65

QUALITY LINE N SCALE WAGONS AND VANS

Ready-to-Run

Peco Quality Line Wagons for N are supplied completely assembled and painted, 'ready-to-run' on your layout.

Faithful reproductions of the prototype they set a very high standard of perfection – Peco perfection.

Fully detailed

These delightful true British N scale models not only possess every possible detail, i.e. rivets, strapping, planking, ladders, full brake gear in line with the wheels, but the bodies are painted in correct Railway Company or Private Owner liveries and fully lettered.

Where appropriate, the wheels even have white tyres. They are indeed complete in every way, and yet each wagon is a robust scale model and fully guaranteed.



Constant scale

Peco were the first to introduce a comprehensive range of 10ft and 15ft wheelbase wagons to constant British N scale.

They are fitted with the Peco 'Elsie'* coupling, housed in a small inconspicuous pocket making possible the close and easy coupling of vehicles.

The resulting exact scale distance between wagons enables eleven Peco wagons to be coupled together in the same length as ten wagons fitted with ordinary spring mounted couplings.

Despite this, the Elsie coupling is still 'universal', conforms to international N standards and couples with other makes of wagons.

Really long trains

Apart from the superb realistic appearance of Peco Quality Line Wagons, the wheels have correct profile and back-to-back measurements and are moulded in a special plastic making the wagons exceptionally free running. This means longer, more realistic goods trains can be run with the same motive power.

Superb value

All parts of the wagons are moulded separately in the correct material – no less than four different plastics are used to produce the very best results for each section of the wagon. All this meticulous care, yet they are so reasonably priced.

For the scratch-builder

The wagons are also supplied unpainted in kit form for enthusiasts who wish to finish them in their own liveries (see page 58).

* 'Elsie' – ELC, stands for 'Easy Light Lift Closing Coupling', (patented).

RAILWAY COMPANY SERIES – 10 ft WHEELBASE



NR-39E
LNER Single Bolster Wagon



NR-40M
LMS 5 Plank Mineral Wagon



NR-41S
SR 7 Plank Coal Wagon



NR-43W
GWR Standard Type Box Van



NR-42E
LNER Refrigerator Type Box Van



NR-45S
SR Cattle Truck



NR-44W
GWR Butterley Steel Type Coal Wagon



NR-45W
GWR Cattle Truck



NR-44E
LNER Butterley Steel Coal Wagon



NR-39M
LMS Single Bolster Wagon



NR-40S
SR 5 Plank Mineral Wagon



NR-41W
GWR 7 Plank Coal Wagon



NR-43M
LMS Standard Type Box Van



NR-45M
LMS Cattle Truck



NR-41M
LMS 7 Plank Mineral Wagon



NR-40W
GWR Single Bolster Wagon



NR-40E
LNER 5 Plank Wagon



NR-41E
LNER 7 Plank Wagon



NR-42E
LNER Standard Type Box Van

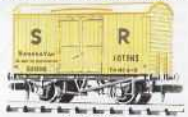

NR-42S
SR Banana Box Van



NR-45E
LNER Cattle Plank Wagon

RAILWAY COMPANY SERIES

- 10ft & 15ft continued



NR-10S

SR Tarpaulin Wagon



NR-20

GWR Furniture Removals
Container and Conflat Wagon

NR-P108

Chatterley Whitfield
7 Plank Coal Wagon

NR-P96

Princess Royal 7 Plank
Coal Wagon

NR-P91

Parkend 7 Plank Coal
Wagon

NR-P99

Grigglesstone 7 Plank
Coal Wagon

NR-47

MR Goods Brake



NR-28E

LNER Goods Brake



NR-P105

Eastwood 7 Plank Coal
Wagon

NR-P98

Ammanford 7 Plank
Coal Wagon

NR-P94

Norchard 7 Plank Coal
Wagon

NR-P95

Lydney 7 Plank Coal
Wagon

NR-21

LMS Furniture Removals
Container and Conflat Wagon

NR-4E

LNER Bolster Wagon



NR-P107

Tredegar 7 Plank
Coal Wagon

NR-P84

Hopton Wood 5 Plank
Mineral Wagon

NR-P87

Cumberland 5 Plank
Mineral Wagon

NR-P88

Allbutt 5 Plank Coal
Wagon

NR-48M

LMS Goods Brake



NR-5W

GWR Plate Wagon



NR-P89

Stevenson 5 Plank Coal
Wagon

NR-P111

Dowlow Lime Wagon



NR-P121

Shaka Salt Wagon



NR-P120

Saxa Salt Wagon



NR-49E

LNER Goods Brake



NR-7W

GWR Tube Wagon



NR-P113

SLB Lime Wagon



NR-P100

Charringtons Butterley
Steel Coal Wagon

NR-P114

I.C.I. Lime



NR-P106

Bradford 7 Plank Coal
Wagon

Special production
this will only be available
while stocks last

PRIVATE OWNER SERIES - 10ft WHEELBASE

PRIVATE OWNER SERIES –
10ft WHEELBASE continued



NR-P12
Crawshaw Brothers
Lime Wagon



NR-P85
Cramote
7 Plank Mineral Wagon



NR-P86
Constable Hart
7 Plank Mineral Wagon



NR-P130
Worthington Standard Type
Box Van



NR-P162
National Benzole Petrol
Tank Wagon



NR-P31
Lyons Tea Container
and Contail Wagon



NR-P141
Colman's Refrigerator Type
Box Van



NR-P140
Fyffes Refrigerator Type
Box Van



NR-P163
Royal Daylight Petrol
Tank Wagon



NR-P168
Express Dairy Milk
Tank Wagon



NR-P160
Shell/ BP Petrol Tank Wagon



NR-P167
United Dairies Milk
Tank Wagon

BR SERIES – 10ft & 15ft
WHEELBASE



NR-44B
BR Butterley Steel
Coal Wagon



NR-43B
BR Standard Type
Box Van



NR-22
BR Furniture Removals Container
and Contail Wagon



NR-28B
BR Goods Brake

MODERN SERIES – BR RAILFREIGHT
& BR 15ft (& 10ft) WHEELBASE



NR-28R
BR Railfreight Brake Wagon



NR-11R
BR Railfreight Open Wagon



NR-42R
BR Railfreight Box Van



NR-9B
BR Parcels Van



NR-12R
BR Railfreight Van



NR-7R
BR Railfreight Tube Wagon



NR-6B
BR Fish Van

MODERN SERIES – PRIVATE OWNER 15ft WHEELBASE



NR-P54
Army Pallet Van



NR-P65
Dewar's Whisky Grain Wagon



NR-P69
White Horse Whisky Grain Wagon



NR-P75
Albright & Wilson Tank Wagon



NR-P55
Ford Pallet Van



NR-66
Grain Wagon



NR-P70
Maltsters Association Whisky Grain Wagon



NR-P79
Mobil LP-gas Tank Wagon



NR-P56
Izal Pallet Van



NR-P67
Abbot's Choice Whisky Grain Wagon



NR-P71
ICI Caustic Soda Tank Wagon



NR-300
HAA Merry Go Round Hopper Wagon
Scheduled release end 2000



NR-P64
Grant's Stand Fast Whisky Grain Wagon



NR-P68
Haig Whisky Grain Wagon



NR-P74
Rugby Cement Tank Wagon

Peco Quality Line Wagons are also available in kit form – see page 58

Occasionally we produce special wagons for customers.

For more information write to Peco Technical Advice Bureau

QUALITY LINE WAGON KITS

The wagon types shown on the previous pages, are also available unpainted and unlettered in kit form.

9ft WHEELBASE KITS

- BR 16 ton Steel Mineral Wagon KNR-207
- BR 27 ton Ironside Tippler Wgn. KNR-208
- BR 20 ton Pig Iron Wagon KNR-209

7Plank Open Wagon KNR-220

- 10ft WHEELBASE KITS
- Conflat KNR-20
- Single Bolster Wagon (pair) KNR-39

- 5 Plank Open Wagon KNR-40
- 7 Plank Open Wagon KNR-41
- Butterfly Steel Type Open Wagon KNR-44

- Refrigerator Type Box Van KNR-42
- Standard Type Box Van KNR-43
- Cattle Truck KNR-45
- LMS Type Goods Brake KNR-48
- LNER Type Goods Brake KNR-49

- Tank Wagon KNR-167
- Salt Wagon KNR-120

15ft WHEELBASE KITS

- Bolster Wagon KNR-4
- Plate Wagon KNR-5
- Tube Wagon KNR-7
- Tarpaulin Open Wagon KNR-10
- Pallet Van KNR-8
- Parcel/Fish Box Van KNR-9
- Tank Wagon KNR-50
- Whisky Grain Wagon KNR-67
- LNER/BR Type Goods Brake KNR-28

Use the Electro-Magnetic Decoupler shown on page 59; not suitable for couplings with a spring



16 ton Mineral Wagon
KNR-207



KNR-208



KNR-207



SR TYPE GOODS BRAKE KIT KNR-29

Not available ready-to-run.

Detailed moulded plastic parts to assemble your own SR Brake Van. Includes separate look-out ducts, solid doors and sand boxes. Unpainted and unlettered. Black 15ft chassis and running boards.



KNR-8



KNR-7



KNR-67



KNR-167



KNR-42



KNR-45



CHASSIS KITS

All the chassis parts required on which to mount your own bodies. The kits are complete with underframe, wheels, metal weight, 'Elsie' couplings and coupling pocket plugs

10ft Wheelbase, Wagon Chassis With steel type solebars. NR-120
 9ft Wheelbase, Wagon Chassis With steel type solebars. NR-120
 10ft Wheelbase, Wagon Chassis Wooden type solebars. NR-123



NR-121



NR-120



NR-123



NR-121B



NR-122



NR-122B

These superbly detailed chassis kits are complete with underframe, wheels, metal weight, 'Elsie' couplings and coupling pocket plugs.

10ft Wheelbase, Wagon Chassis With steel type solebars. NR-121
 10ft Wheelbase, Goods Brake Chassis With steel type solebars. NR-121B
 15ft Wheelbase, Wagon Chassis With steel type solebars. NR-122
 15ft Wheelbase, Goods Brake Chassis With steel type solebars. NR-122B

NR-122B

ELECTRO-MAGNETIC DECOUPLER SYSTEM

Electro-Magnetic Decoupler PL-25
 Designed specially for use with the Peco 'Elsie' (ELC) couplings - as fitted to Peco N Quality Line Wagons.

It is not suitable for use with couplings that incorporate a spring.

The Electro-Magnetic Decoupler operates in conjunction with the special Lift Arms (NR-103) which, when attached to the couplings, are activated by the electro magnet hidden under the baseboard.

Installation requires only a single small hole between two sleepers and the unit being screwed to the underside of the baseboard using the bracket supplied. Very simple and effective.

Full instructions are included.

N Coupling Lift Arms NR-103

For use with the Electro-Magnetic Decoupler system (PL-25) and Peco 'Elsie' couplings (NR-102) - as fitted to Peco N Quality Line wagons.

They are not suitable for use with couplings that incorporate a spring.

18 per pack with full instructions.

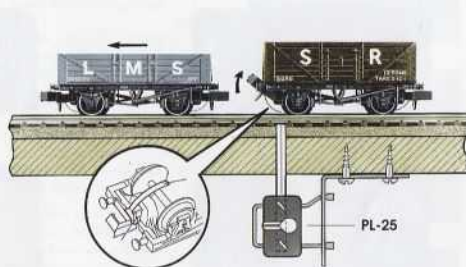

PL-25

As supplied on fret of 18

NR-103

Curved over 1p coin edge

NOTE: This decoupler has no moving parts, it works by an electromagnetic field and when assembled properly should have sufficient power to lift on its own, when energised.



NR-100



NR-101



NR-102



NR-206

WHEELS, COUPLINGS AND COKE EXTENSION BOARDS

Wheels on Axles
 Made from 'Hardlon', a material not to be confused with ordinary plastic, these Quality Line Wheels are moulded integrally on pin-point axles and cannot go out of gauge.

Disc NR-100

Spoked (Smaller flanges) NR-101

'Elsie' (ELC) type Couplings and Pockets (4) NR-102
 'Hardlon' mouldings.

Coke Extension Boards NR-206
 Detailed black plastic mouldings supplied in kit form, two ends and two sides easily cemented together. Designed to fit Peco 10ft wheelbase 7 plank coal wagons and suitable for use with the Coal/coke Wagon Load (NR-201) which will fit inside to represent the coke. See illustration on page 60.

The Extension Boards can be used with other makes of wagons of similar size.

CONTAINERS

Add variety and interest to your trains with these beautifully detailed, painted and lettered containers.

Packed in pairs - wagons not included.

GWR & LMS Furniture Removals
One of each. NR-207

BR & LEP Furniture Removals
One of each. NR-208

Raleigh Cycles & Lyons Tea
One of each. NR-209



NR-207



NR-208



NR-209



WAGON LOADS

Moulded in realistic correct colour plastic. As supplied, they each fit neatly into 10ft wheelbase open wagons. The mouldings are cleverly designed to divide in half, therefore by joining one and a half loads together they will also fit 15ft open wagons - see illustration. Supplied in sets of 4 of one type.

Sand, natural/buff NR-200
Sand, red/brown - Devon etc. NR-200R

Sand, china clay/lime - white/grey NR-200W
Coal/coke, black NR-201
Granite, grey - ballast etc. NR-201G

Granite, red - ironstone NR-201R
Bricks, red NR-202
Bricks, terracotta NR-202T
Bricks, blue NR-202B
Timber, natural NR-203
Barrels, dark brown NR-204
Crates, natural timber colour NR-205



NR-204 NR-200



NR-202 NR-205



NR-203 NR-201



Use 1 1/2 loads to fit 15ft open wagons.



Mk IV 10ft SERIES TANK WAGON KITS

First introduced in May 1954, Peco Wonderful Wagons have continuously led the way with their superb detail and working features.

The Mk IV OO/HO series retains all the previous famous features plus a host of new ones making them quite exceptional.

A re-tooled underframe and with all-plastic bodies the Mk IV series fully maintains their unbeatable reputation.

- Actual working axlebox springs.
- Sprung metal buffers.
- Fully painted and lettered body.
- Parts in correct colours – no painting necessary.
- Pin-point axles running in special bearings for maximum length trains.
- Two sets of couplings included so that you can choose between Peco Magni-Simplex or Peco Anita tension lock types*

The Anita coupling is fully compatible with Hornby™, Dapol™ etc.

* Both types of coupling are available separately (see page 60).

PETROL TANK WAGONS

Royal Daylight, Tank Wagon Kit R-75RD

Shell/BP, Tank wagon Kit R-75S

MILK TANK WAGONS

Express Dairy, Tank Wagon Kit R-74E

United Dairies, Tank Wagon Kit R-74U



R-75RD



R-75S



R-74E



R-74U

WAGON CARDS

Mk III Series

Whereas the complete Mk III Wonderful Wagon kits are no longer in production, the following full colour, printed and embossed, wagon side and end cards are still available separately for those who wish to make up their own kits using the famous Peco underframe R-20 and accessories (see pages 62 & 63).

CLEAN FINISH CARDS

3 PLANK LOW SIDE WAGON CARDS

Field & MacKay, brown R-62FM

Pwllheli Granite Co Ltd, black R-62PG

Blaenavon Company, brown R-62BC

5 PLANK MINERAL WAGON CARDS

Garswood, blue R-70G

Charles Dunsdon, green R-70D

Mendip Mountain Quarries, grey R-70M

Tarmac, black R-70T

Derbyshire Stone Ltd, black R-70DS

Bibbington, buff R-70B

Dixon, red oxide R-70DN

7 PLANK COAL WAGON CARDS

Baddesley, black R-54B

Kingsbury, green R-54K

Pinxton, black R-54P

Newbattle, black R-54N

Hood & Son, holly green R-54H

LIME WAGON CARDS

Crawshaw Brothers, buff R-68C

SLB, grey R-68S

South Wales Lime, white R-68SW

GRAIN WAGON CARDS

Leith General Warehousing, bauxite R-58LW

SALT WAGON CARDS

ICI Salt Division, blue R-58ICI

Union salt, grey R-58UIS

Saxa Salt, yellow R-58XS

Stafford Salt Works, red R-58SS

Shaka Salt, blue R-58S

BOX VAN CARDS

Colman's Mustard, yellow R-72C

Fyffes Bananas, yellow R-72F

Worthington, brown R-72W

Bass, grey R-72B

Carricks, black R-72CK

Blue Circle Cement, yellow R-72BC

J & W Stuart, brown (vertical planking) R-72S

CONFLAT WAGON CARDS

Conflat, single plank, bauxite R-64

WEATHERED FINISH CARDS

Mineral 5 plank, Dixon, red oxide RW-70D

Mineral 5 plank, Garswood, blue RW-70G

Coal 7 plank, Emlyn, green RW-54E

Coal 7 plank, S Moseley & Sons, grey/red RW-54M

Coal 7 plank, Anderson & Co, brown RW-54A

Lime Wagon, Dowlow, reddish brown RW-68D

Salt Wagon, Shaka, blue RW-58S

Box Van, Blue Circle, yellow RW-72BC

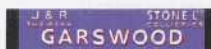

R-70G



R-68S



R-72BC



R-72S



R-58SS



R-72CK

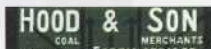

R-54H



R-72C



R-62PG



R-70DN



R-70D



R-72W



R-72B



R-58SX

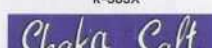

R-58SH



R-54K



R-68C



R-70I

CONTAINER KITS

A beautifully printed series of card kits in authentic colours with embossed strapping and rivet detail.

Assembly is very simple and when made up they are strong, yet light in weight, adding little to the load.



Lyons Tea, Container R-66JL



Raleigh Cycles, Container R-66R



Silver Cross, Container R-66SC



British Rail, Container R-66BR

WONDERFUL WAGON UNDERFRAME KIT

Mk IV 9ft/10ft TYPE R-20
Incorporate the special features of the latest Mk IV kits in your own wagon building.

This Underframe Kit includes a choice of either 9ft wooden type or 10ft metal type solebars, sprung metal buffers, working axlebox springs, accurately detailed brake gear and mountings for two types of coupling.

Designed for use with Peco wheels, bearings and couplings, all available separately, see right and page 63.



R-20

AUTO COUPLINGS**MAGNI-SIMPLEX AUTO COUPLING R-3**

A superb auto coupling designed for magnetic operation using the special Decoupler SL-32 (see page 31).

It will couple with the original Simplex Auto Coupling (R-2) and still retains the feature that allows a vehicle to be lifted straight from a train without causing derailment.

It also facilitates delayed uncoupling, so that a vehicle can be propelled along the track and left in any desired position.

The Magni-Simplex can be fitted to other makes of rolling stock besides Peco.

Supplied complete with spring, screw and adaptor moulding.

SIMPLEX AUTO COUPLING R-2

The original Simplex Coupling, designed by Peco and adopted by both Hornby-Dublo™ and Trix™ in the 1940's. Inconspicuous in use and simple to operate, it allows a vehicle to be lifted straight from a train without causing derailment.

See page 31 for decoupler (SL-30).

ANITA TENSION-LOCK COUPLING R-4

A smaller, neater version of the type currently used by Hornby™ etc.

It will couple with other current makes of tension-lock couplings including Hornby™, Dapol™ etc.

This illustration shows the complete application. Magni-Simplex Auto coupler in conjunction with the magnetic decoupler, see page 31.



R-2

R-4

R-3

BELOW: A realistic and colourful train of wagons constructed using the Peco wagon cards (page 61), underframe kits, roof moulding (page 63) and a container kit.



WONDERFUL WHEELS AND BEARINGS

Made from a material not to be confused with ordinary plastic, Peco Wonderful Wheels are moulded integrally with pin-pointed axles* and cannot go out of gauge.

Used in conjunction with Peco Wonderful Bearings (R-15) they provide super free running for really long trains.

Suitable for use with both Fine (code 75) and Universal (code 100) tracks.

Spoked Wagon Wheels, 12mm dia. R-10

Disc Wagon Wheels, 3 hole, 12mm dia. R-11

Disc Coach Wheels, 2 hole, 14mm dia. R-12

Mansell Coach Wheels, 14mm dia. R-13

Plastic Bearings (for use with the above) R-15

Tender Wheels, 16mm dia. R-18

*Tender Wheels have plain ended axles (necessary for the extra weight involved) and should only be used with Peco Brass Bearings (R-30).

Brass Bearings, (for use with R-18) R-30



R-10



R-11



R-12



R-13



R-18



R-15



R-30

FIBRE WASHERS

Fibre washers for placing between wheels and axle boxes, and having many other uses where insulation is essential.

Washers, Type OO/6 R-8
1.575mm (1/16in) dia. hole for use on rolling stock axles.

Washers, Type OO/O/8 R-9
3.175mm (1/8in) dia. hole for locomotive axles.

INSULAXLES

R-5

Metal rolling stock wheels can be mounted on these specially treated metal axles which provide the necessary insulation for two rail operation.

Not suitable for locomotive wheels.

ROOFS

Originally supplied in the Mk III Wonderful Wagon Kits, these injection moulded roof components are ideal for use when building your own wagons and vans. Suitable for use with the Peco wagon cards, (see page 61).

LIME WAGON ROOF R-35
Moulded in light grey plastic. Detail includes strapping and doors.

SALT WAGON ROOF R-36
Black plastic moulding. Detail includes rain-strips, strapping etc.

BOX VAN ROOF R-37
Black plastic moulding. Detail includes rain-strips, strapping etc.



R-9



R-8



R-5



R-35



R-36



R-37

COKE EXTENSION BOARDS

R-6

Detailed black plastic moulded extension board components. Two sides and two ends to cement together.

Designed to fit 7 plank wagons.

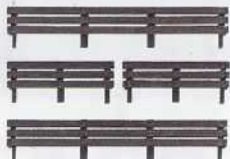

R-6



Coke load and wagon are not included.



W-607

Close up showing the finely detailed working axlebox spring and axleguard



7mm scale WONDERFUL WAGONS

A range of super detailed O gauge wagon, van and brake van kits designed to satisfy the most discerning modellers.

These masterpieces are easy to assemble from the correctly coloured injection moulded components, (no painting required) which feature simulated wood graining, nuts, bolt heads and rivets – even opening doors.

Fine scale metal tyred, spoked wheels and pin-point steel axles with brass bearings provide really excellent running. The buffers are fully sprung and 3 link couplings are included.

The BR Series W-607, W-608 and W-609 also feature actual working axlebox springs, 3-hole disc wheels and movable brake levers (the latter providing for extra realism in close-up photography).

Fully illustrated instructions included.

BR SERIES WAGON KITS

BR 16 TON WELDED STEEL TYPE MINERAL WAGON KIT

W-607

With opening side and end doors, working axlebox springs and movable brake levers.

Transfers include six different numbers.

BR 27 TON WELDED STEEL TYPE IRON ORE TIPPLER WAGON KIT

W-608

Once common on all regions of British railways. All the usual super detail features plus working axlebox springs and movable brake levers.

Transfers include six different numbers.

BR 20 TON PIG IRON WAGON KIT

W-609

BR produced four different designs of pig iron wagon. This kit represents the 20 ton

version built to diagram 4. The heavy weight of these wagons when loaded required tie-bars between the axleguards to ensure efficient action of the brakes.

Transfers include six different numbers.



W-606

GWR SERIES WAGON KITS

GWR 10 TON 4 PLANK OPEN WAGON KIT

W-604

Several thousand of these wagons were built between 1888 and 1902. Kit includes opening central side-drop doors, 'cast-iron' name and number plates and transfers.

GWR 8 TON PERMANENT WAY STEEL TYPE OPEN WAGON KIT

W-605

With opening double side-drop doors. Used on track maintenance trains with the Permanent Way Brake Van

GWR 10 TON VENTILATED BOX VAN KIT

W-606

In general use for transporting perishable goods from 1925 right through to nationalisation in 1947. Some were converted for banana traffic whilst another version was used as a fish van. Kit includes a choice of end ventilators and roof vents to suit these different applications.



W-604



W-605



W-608



W-609

**GWR TOAD 16 TON
BRAKE VAN KIT W-601**
The GWR Goods Brake Van took this standard form in 1888 with the introduction of channel steel underframe and rolled 'T' and 'L' section body framing.

This kit depicts the van in the 1920s period with the larger lower stepboards and continuous lower handrails.

**GWR PERMANENT WAY
BRAKE VAN KIT W-602**
The GWR built a total of 57 of these special brake vans between 1890 and 1900. They were used in conjunction with the open wagon (W-605, on previous page) on track maintenance trains.

**GWR 24 TON SIX-WHEEL
BRAKE VAN KIT W-603**
62 of these heavier brake vans were built between 1900 and 1902. In order to utilise the chassis of previous AA3 vans a centre axle was added and brakes on all 6 wheels. This kit depicts the van in the 1920s period with the larger lower stepboards and continuous lower handrails.



W-601



W-602



W-603

WONDERFUL UNDERFRAME KIT & ACCESSORIES

**WONDERFUL WAGON
BR UNDERFRAME KIT RO-8**
Includes working axlebox springs, sprung buffers, 3-link couplings, floor, detailed solebars and buffer beams, full brake gear with alternative types of brake lever and a choice of 'open' or 'solid' type axleguards.

Designed for use with Peco Wheels and Bearings, available separately, see below.

WONDERFUL WHEELS AND BEARINGS

Free running, correct profile metal rims on moulded centres with metal axles, representing the prototype RCH 3ft 1 1/2in diameter wheels.

Supplied in packs of two pairs of wheels with four brass bearings.

Spoked Wheels & Bearings

RO-1

3-hole Disc Wheels & Bearings

RO-2

VACUUM BRAKE FITTINGS & PIPES

RO-6

Dean Churchward short brake lever, brackets and rodding, vacuum pipes and cylinder, plus steam pipes.

Enough parts to fit one wagon.

GWR BUFFER & COUPLING SETS

4 metal buffer heads, 4 brass buffer shanks, 4 brass collars, 4 brass spring locators, 2 metal spring rods, 2 black plastic couplings and 6 metal coupling links.

Enough for one wagon.



RO-8



RO-1



RO-2



RO-6



RO-6



RO-4



RO-4

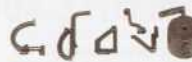

RO-5

BUFFERS

Parallel Shank type plastic housing included

RO-2

Tapered Shank type

RO-3

3-LINK COUPLINGS

AND HOOKS

RO-4

Pack includes 8 hooks & 24 links.

Enough for four wagons.

INSTANTAN COUPLINGS AND GEDGE HOOKS

8 Gedge hooks, 8 Gedge type links & 16 standard links.

Enough for four wagons.



NARROW GAUGE LOCOS & ROLLING STOCK

Over the past decade or so, narrow gauge railways have become popular subjects for modelling. One of the many reasons why this has come about is the success of the many preserved narrow gauge lines that now run as tourist attractions. Saved from extinction by railway enthusiasts, railways such as the Talylyn and Ffestiniog have done much to bring the narrow

gauge scene to the attention of potential modellers.

An equally important feature when choosing what type of railway to model is that narrow gauge lines incorporate sharp curves and this is of great help when designing a layout to fit in a restricted space.

Last, but by no means least, the range of models, kits and accessories available has increased spectacularly over the

past few years. Peco has long been at the forefront of promoting narrow gauge – the excellent range of special Streamline tracks has in no small way helped to popularise the genre.

In addition to track, Peco produces a range of narrow gauge locomotive and rolling stock kits, all designed to add the essential narrow gauge charm to your layout.

N-6.5

The introduction of Z gauge has made it possible to model narrow gauge in N scale – namely N-6.5. Peco produce two locomotive body kits for N-6.5. The accurately cast white metal components are designed for use with Märklin Miniclub™ chassis, running on Peco Z gauge Streamline track (see page 11). Two typical narrow gauge

wagons are also to be available in kit form.

OO-9

Three Peco locomotive body kits are available – two of freelance design and one based on the well known Beyer-Peacock™ 'Tram' type locomotive.

In addition a narrow gauge type coupling is available separately and is compatible with Bemo™ type couplers. It can be used with Peco N chassis kits.

A wide range of OO-9 rolling stock is available from other manufacturers – see the PPP Catalogue for details.

O-16.5

This deservedly popular size offers the advantage of 7mm scale (excellent for lovers of detail modelling) combined with the use of 16.5mm gauge (OO/HO). The latter means that you can take advantage of the wide range of wheels, mechanisms etc. that are available for OO.

Peco produce three fully detailed Locomotive body kits based on well-known

prototypes. These superb kits are produced in white metal with brass and nickel silver wire included to make up the all important piping and handrails. To complete the locomotives, specially designed chassis are available from Branchlines™ with motors.

For the locomotives to haul, is a series of O-16.5 coach and wagon kits – all based on typical narrow gauge prototypes. The complete coach kits have injection moulded, plastic, panelled sides and ends, and are supplied ready painted and lined. The wagons available include the once ubiquitous slate wagon, essential when modelling the Welsh narrow gauge scene.

*LEFT: Talylyn Railway No.1 'Talylyn' at Rhydronen station. This famous locomotive is available in kit form in O-16.5 scale, see page 68
Photo by Michael Howard.*

INDEX TO NARROW GAUGE ROLLING STOCK

N-6.5 Loco Body Kits	67
N-6.5 Wagon & Van Kits	67
OO-9 Loco Body Kits	67
O-16.5 Loco Body & Chassis Kits	68
O-16.5 Coach Kits	69
O-16.5 Wagon & Van Kits	69

N-6.5 GREAT LITTLE TRAIN KITS

LOCOMOTIVE BODY KITS

The introduction of Z gauge has made it possible to model narrow gauge in N scale – namely N-6.5.

Peco produce two locomotive body kits for N-6.5. The accurately cast white metal components are designed for use with Märklin Miniclub™ 0-6-0 chassis, running on Peco Z gauge Streamline track (see page 11). Full instructions included with each kit.

TRAM LOCOMOTIVE BODY KIT

NG-651
This delightful model of a Beyer-Peacock™ Tram Locomotive need not be restricted to roadside use – it is equally at home on any part of a narrow gauge railway system.

0-6-0 SADDLE TANK



NG-652



NG-624



NG-651



NG-625

BODY KIT

A typical (freelance) example of a narrow gauge saddle tank locomotive.

NG-652

WAGON AND VAN KITS*
Two typical narrow gauge wagons for use with the N-6.5 locomotive kits.

Detailed plastic parts. Full instructions are included.

4 wheel Open Wagon kit NG-624

4 wheel Box Van kit NG-625

*Only available through
Peco Technical Advice Bureau

OO-9 GREAT LITTLE TRAIN KITS

LOCOMOTIVE BODY KITS

These 4mm scale body kits are easily assembled from the accurately cast white metal components and all are designed to fit a Graham Farish™ chassis.

The heavy white metal body helps provide good adhesion. The locomotives are therefore particularly suitable for the steeper gradients so often incorporated in narrow gauge layouts.

'JEANETTE' SIDE TANK LOCOMOTIVE BODY KIT GL-1

A free-lance design that captures the essence of a typical narrow gauge locomotive. Full of charm and character, a reminder of the good old days which have been recaptured to some degree – thanks to the many preservation



GL-1



GL-2



GL-6

societies that now operate.

Designed to fit a Graham Farish™ 0-6-0 Pannier tank chassis it can be modified for other types.

'JAMES' SADDLE TANK LOCOMOTIVE BODY KIT GL-2

A 'brother' for 'Jeanette' – this delightful freelance model will be at home on any OO-9 narrow gauge layout.

Designed to fit a Graham Farish™ 0-6-0 Pannier tank chassis it can be adapted to fit other makes.

TRAM LOCOMOTIVE BODY KIT GL-6

Although the Beyer-Peacock™ prototype of this 'Tram' type locomotive was usually to be found running alongside the road, this attractive model does not need to be restricted to road use only.

Designed to fit the Graham Farish™ 0-6-0 chassis.

Because of its 'skirted' design, the kit can easily be adapted for use with other makes of chassis.

OO-9 NARROW GAUGE COUPLING GR-101

Typical narrow gauge type coupling for modellers wishing to build their own stock. It fits Peco N gauge wagon chassis (see page 59) which can be used for OO-9 narrow gauge underframes. Compatible with Bemo™ type couplings.



GR-101

Photo: Shunting at Pendre on the Talylyn Railway.

Photo by John Macdougall.



GREAT LITTLE TRAINS LOCOMOTIVE BODY KITS

A superb series of fully detailed white metal body kits for O-16.5 narrow gauge in 7mm scale.

The parts include various thicknesses of brass and nickel silver wire to make up the necessary piping and handrails. All the kits are designed for fitting the Peco Simplex Auto Couplings R-2 (see page 62), but scale narrow gauge couplings can easily be fitted if preferred.

Comprehensive, step-by-step instructions are included with each kit.

The Branchlines™ chassis kits shown are specially designed to fit these Peco bodies and are available with motors.

0-4-2 TRAM LOCOMOTIVE OL-1
This fascinating Beyer-Peacock™ Tram Locomotive need not be restricted to roadside use, being equally at home on any part of a narrow gauge layout. Fully detailed – even down to including a shovel and oil can.

Additional parts are included to model this locomotive at various stages of its life – as originally built or as modified in later years.

Branchlines™ Chassis Kit for OL-1 BL-3
Complete with motor and gears.

0-4-2 FLETCHER JENNINGS™ SADDLE TANK LOCOMOTIVE OL-2

A superb model of this famous narrow gauge locomotive from the Mid-Wales Talylyn Railway.

The components supplied incorporate a wealth of detail including the cab fittings.

Branchlines™ Chassis Kit for OL-2 BL-5
Complete with motor and gears.

0-4-0 HUNSLET™ QUARRY LOCOMOTIVE OL-3

A really superb kit of a widely used prototype, one of which originally operated on the North Wales Dinorwic Slate Quarry Railway. Extremely well detailed, the kit includes cab fittings – a real 'must' in O-16.5 scale.

Branchlines™ Chassis Kit for OL-3 BL-1
Complete with motor and gears.

See page 46 for Streamline O-16.5 narrow gauge track and turnouts for use with these locomotives.



OL-1



OL-2



OL-3



BL-3



BL-5



BL-1

GREAT LITTLE TRAINS 4 WHEEL COACH/BRAKE KITS

Really superb coach kits based on typical narrow gauge prototypes. Fully detailed parts assemble into very attractive models that should be acquired for your own 'Railway Company'.

The kits comprise chassis components, plastic moulded sides, ends, roof, duckets, central and side buffers, Peco Wonderful Wheels and a comprehensive illustrated instruction sheet.

There is a choice of livery, with either maroon or green sides, both are fully lined (but not lettered).

These coach kits are extremely versatile; the duckets supplied (fig.1) convert the coach into a guard's van/brake if desired.

The instructions also show how to make an open version (fig.2), or (using three kits), how to build a bogie type coach (fig.3), the bogies are not supplied.

Couplings, paint and transfers are not included in the kits.

- 4 Wheel Coach/Brake Kit Maroon OR-31
- 4 Wheel Coach/Brake Kit, Green OR-32

COACH PARTS

A whole range of coaches can be built from these parts, the sides are designed with locating tabs to help line up the parts exactly.

- Single Window Coach Door (6) OR-50
- Single Window Coach Panel (6) OR-51



OR-31



OR-32



FIG.1



FIG.2



FIG.3



OR-50



OR-51



OR-52



OR-53



OR-56



OR-54



OR-55



- Double Window Coach Panel (6) OR-52
- Saloon Window Coach Panel (6) OR-53
- Coach Windows (7) OR-54
- Coach Window Blanks (8) OR-55
- Duckets (4) OR-56

WAGON KITS

Five typical examples based on Welsh narrow gauge rolling stock from the slate traffic era. All are beautifully detailed white metal castings.

Peco Wonderful Wheels are included.

Couplings, paint and transfers are not supplied.

- 4 Ton Mineral Wagon Kit OR-20
- 2 Ton Flat Wagon Kit OR-21
- 2 Ton Bolster Wagon Kit OR-22
- 1 Ton Slate Wagon Kit OR-23
- Side Tip Wagon Kit OR-28

The following two kits incorporate fully detailed plastic moulded chassis and body, 7" components, central and side buffers, and Peco Wonderful Wheels.

Couplings, paint and transfers are not included.

- 4 Wheel Open Wagon Kit OR-24
- 4 Wheel Box Van Kit OR-25

CHASSIS KITS

Build your own design narrow gauge wagons or coaches on these chassis.

Peco Wonderful Wheels are included.

- 4 Wheel Wagon Chassis Kit (plastic) OR-40
- 4 Wheel Coach Chassis Kit (plastic) OR-41



OR-21



OR-28



OR-20



OR-23



OR-25



OR-24



OR-22



OR-40



OR-41

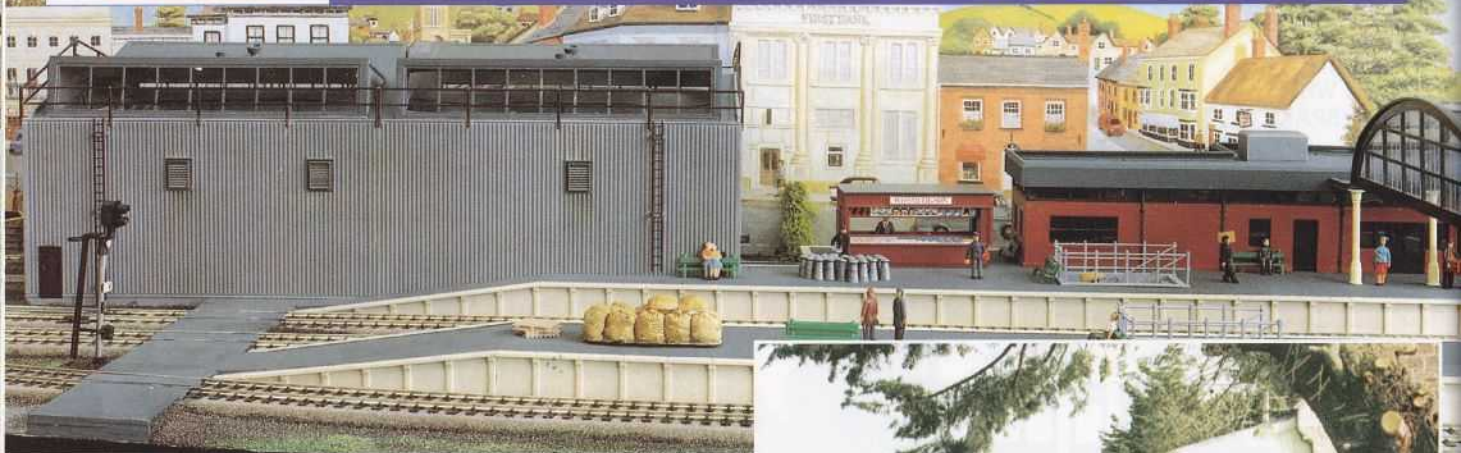

SETTING THE SCENE FOR YOUR RAILWAY

Nowadays, no model railway looks complete without scenery. Indeed, the scenic aspect of many layouts is what gives them their particular individuality and charm. For many enthusiasts the scenic side of layout building has become one of the most exciting parts of the hobby.

It is the scenery, perhaps more than any other feature of a layout, that turns a 'train set' into a complete model railway. The layout will not only look larger, but the sharpness of the curves can also be disguised to good effect.

Whether you are constructing a simple branch line running

through a gentle English landscape or a spectacular narrow gauge line that clings to the sides of high mountains, it is in designing and building the landscape that the modeller can really let his or her imagination take over.

Peco produce a wide range of scenic and lineside kits and materials which can be used to add that all essential realism to your landscape building. From the humble lineside fence to the imposing overall roof or modern train shed unit, Peco attention to detail will undoubtedly breathe 'life' into your layout.

TOP: Conversely, the OO station layout in this photograph could easily be mistaken for the real thing! Closer inspection will enable you to identify many of the Peco Lineside kits and scenic accessories that are featured in this catalogue.

BOTTOM: At first glance, this view of Dunster on the West Somerset Railway could well be a model! A similar scene could easily be built using items from the Peco Lineside and Scenic range. Photo by Peco Studio.



Z ROAD BRIDGE SIDES AND TUNNEL MOUTHS

Finely moulded plastic bridge sides and tunnel mouths. Modelled on typical British prototypes with correct fine stonework detail.

Supplied ready painted in realistic dark stone colour together with smoke/sooty stains represented over the arches for extra realism.

The separate wing/retaining walls can be positioned at varying angles to suit the landscape.

Z TUNNEL MOUTHS

Single Track ZK-231
2 mouths & 4 walls
Width: 62mm (2¹/₂ins)
Height: 40mm (1¹/₂ins)
Wing Length: 37mm (1¹/₂ins)

Double Track ZK-232
2 mouths & 4 walls
Width: 80mm (3¹/₂ins)
Height: 48mm (1⁷/₈ins)
Wing Length: 37mm (1¹/₂ins)

Z ROAD BRIDGE SIDES

Single Track ZK-233
2 sides & 4 walls
Width: 74mm (2⁷/₈ins)
Height: 40mm (1¹/₂ins)
Wing Length: 37mm (1¹/₂ins)

Double Track ZK-234
2 sides & 4 walls
Width: 93mm (3⁵/₈ins)
Height: 45mm (1³/₄ins)
Wing Length: 37mm (1¹/₂ins)



ZK-231



ZK-233



ZK-232



ZK-234

N 'MANYWAYS' TRAIN SHED UNIT KIT

Detailed moulded plastic parts in correct colours to build one complete N Train Shed Unit 168mm (6⁵/₈in) long by 73mm (2⁷/₈in) wide and spanning two tracks.

It is large enough to house the longest BR diesel and electric locomotives, or Mk III coaches.

There are many ways the kits can be joined together to form a shed complex of your choice. A single unit can be used as a diesel maintenance depot, whilst eight or nine kits will provide room for two complete HST trains.

They can be joined end-to-end and side-by-side as required.

Employ them too as industrial units or factories – there are, in fact, no limits to the many uses this versatile kit can have.

Fully illustrated instructions are included for this easy to assemble kit.

N 'Manyways' Train Shed Unit Kit NB-80



NB-80

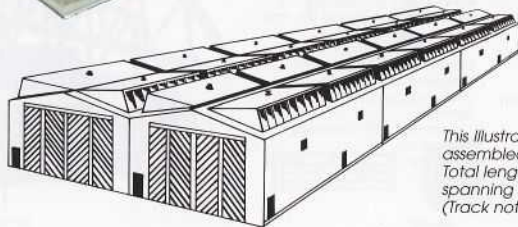

This illustration shows six kits assembled together. Total length 503mm (19³/₈in) spanning 4 tracks. (Track not supplied.)

TRADITIONAL TYPE ENGINE SHED & GOODS SHED KITS

BRICK TYPE NB-5

An attractive single track country type engine shed. Moulded plastic brick red walls and grey slated roof with smoke ventilator. Green door mouldings.

Two or more of these kits can be joined together to form larger sheds or depots as illustrated.

Length: 110mm (4 $\frac{3}{16}$ in)

GOODS SHED KIT WOODEN TYPE NB-6

Typical of the type once found in the goods yards at most stations up and down the country.

Detailed moulded parts in correct colours include simulated red brick base, buff wood walls and slate grey roof.

This kit is ideal for conversion and modification, providing many useful components.

Length: 86mm (3 $\frac{3}{16}$ in)

MODERN TYPE BUNGALOWS & HOUSE

CEDAR WOOD TYPE
BUNGALOW KITS

Typical modern bungalows with simulated cedar wood walls. Complete with all necessary details: guttering and drain pipes, white doors and window frames, plastic glazing, colourful printed curtains, grey tiled roofs and stone chimney stacks.

Easily assembled with or without the bases provided.

Small Bungalow Kit NB-9
Length (excluding base): 67mm (2 $\frac{5}{16}$ in)

Large Bungalow Kit NB-10
Length (excluding base): 92mm (3 $\frac{3}{8}$ in)

SPLIT LEVEL HOUSE KIT NB-11
An attractive modern dwelling complete with built-in garage. Simulated wood walls in grey and natural wood colour, white doors and window frames, clear plastic glazing, colourful printed curtains, guttering and drain pipes, reddish brown tiled roof and grey chimney stacks.

Easily assembled, with or without the base provided.

Length (excluding base): 81mm (3 $\frac{1}{16}$ in)

PLATFORM SHELTER WITH TWO HUTS NB-12
Complete your station scene with these small buildings or use them on their own. This kit is adaptable to many railway usages.
Timber and Brick NB-16



NB-5



NB-12



NB-10



NB-11



NB-9



NB-16



NB-6

'MANYWAYS' STATION BUILDINGS COUNTRY STATION BUILDING KIT

This kit can be used in a variety of different ways to suit your needs with the toilet block on either end of the building and the canopy on either of the long walls.

For larger stations it can be extended using two kits. All components are moulded in colour making painting optional.

Complete with illustrated instructions.

Brick Type

NB-13

Two or more of these kits can be joined together to form larger sheds or depots.

GIRDER BRIDGE SIDES, LEVEL CROSSING GATES AND BARRIERS

TRUSS GIRDER BRIDGE SIDES

NB-38

Detailed plastic mouldings – even including the bolt heads. Supplied in packs of two pairs, suitable for attaching to the bridge deck either upright or underslung, the latter 'supporting' the track.

Two or more can be used end-to-end, to extend the bridge or build an impressive viaduct.

The necessary supporting piers can be constructed from Peco Stone Walling sheets NB-40, see page 74.

Length: 143mm (5⁵/₁₆in)

PLATE GIRDER BRIDGE SIDES

NB-39

Detailed injection mouldings in red oxide colour plastic. Channels are incorporated on the insides for attaching to the deck.

Supplied in a pack of two pairs – more than one pair can be combined end-to-end to make longer bridges or viaducts.

Length: 113mm (4¹³/₃₂in)

LEVEL CROSSING GATES

NB-50

'Traditional' 'wooden' type gates complete with the usual adjacent wicket gates for pedestrians.

Finely detailed, the gates are properly hinged on their posts, giving double track spacing when closed across the tracks.

LEVEL CROSSING BARRIERS

NB-51

These Modern type crossing barriers with their dummy light standards make a most attractive feature for any modern layout.

The detailed plastic mouldings include the side fences.

FLEXIBLE FENCING

NB-45

The Peco Flexible Fencing is a revolution in lineside realism, for it will follow landscape contours in a correct prototypical manner with the posts vertical regardless of the terrain.

The mouldings are produced in a realistic 'weathered' brown colour plastic and are available in packs of five sprues making a total length of 978mm (38¹/₂in).

Flexible Field Fencing is also available for OO/HO and O gauge, see pages 79 and 81 respectively.

FIELD GATES, STILES AND WICKET GATE

NB-46

To complete the fencing system, this pack contains, 3 Field Gates, 3 Stiles and a Wicket Gate. All are finely detailed moulded parts which can be plugged into the fencing sections as required.



NB-39



NB-38



NB-45

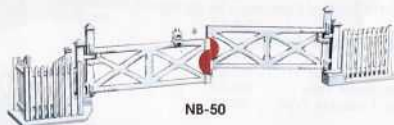

NB-50

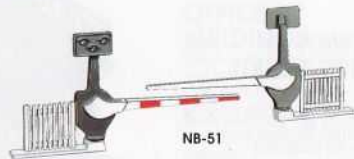

NB-51



NB-46

PLATFORM EDGING

Fully detailed, appropriately coloured injection moulded plastic sections of three types of platform edging and ramp; brick, concrete and stone.

Using these components, the construction of straight or curved platforms is simplicity itself (see illustration).

With Peco Edging Strips you can build platforms to suit any track formation.

Length: 144mm (5^{11/16}in)

plus fixing tab.

Platform Edging, Brick type NB-26

Platform Edging, Concrete type NB-27

Platform Edging, Stone type NB-28

Ramp, Brick type NB-66

Ramp, Stone Type NB-67

Ramp, Concrete Type NB-68



The construction of straight or curved platforms is simplicity itself using these Edging sections.



SUBWAY STAIRCASE KIT

NB-7
Designed to fit into the platform top without the need to cut a hole in the baseboard.

The kit contains parts to make two subway staircase units or can be modified to make one of greater depth. Hand rails are brass etched in order to keep a scale looking appearance.

Although designed primarily for stations it can be used for other underpass situations.

BRIDGE SIDES, TUNNEL MOUTHS & WALLING

ROAD BRIDGE SIDES & TUNNEL MOUTHS

Detailed simulated stone Bridge Sides and Tunnel Mouths with separate wing retaining walls for optional positioning. All injection moulded in realistic grey colour plastic.

Road 'decking' is not included as the width of this can vary according to layout requirements.

Road Bridge Sides, for single track NB-33

Road Bridge Sides, for double track NB-34

Tunnel Mouths, for single track NB-31

Tunnel Mouths, for double track NB-32

STONE & BRICK WALLING SHEETS

Unavailable detailed simulated Stone and Brick Walling Sheets injection moulded in appropriate colour plastic.

The Stone sheets match the Bridge Sides and Tunnel Mouths.

Supplied in packs of 4 sheets, 64mm (2^{1/2}in) high by 127mm (5in) long and 1.5mm (1/16in) thick.

Stone Walling Sheets, Grey NB-40

Brick Walling Sheets, Terra cotta NB-43

Brick Walling Sheets, Blue NB-44

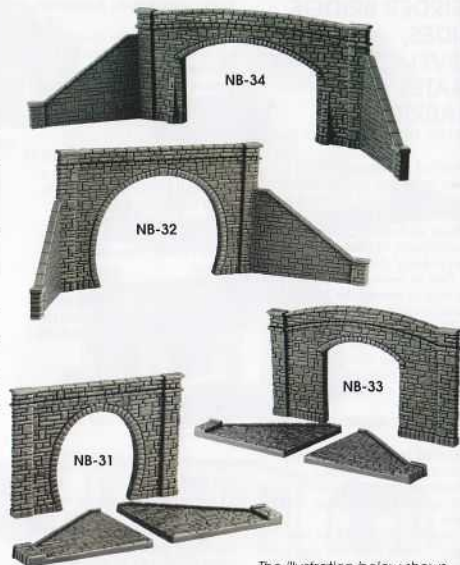

The illustration below shows how Bridge Sides and Stone Walling Sheets can be used together to good effect.



'MANYWAYS'

TRAIN SHED UNIT

As a single unit this superbly detailed and versatile Peco 'Manyways' kit is large enough to take the longest BR diesel or electric locomotives on each track.

You can join the units together, end-to-end and side-by-side, to provide accommodation for complete HST sets and diesel and electric multiple units. Used thus, it can also represent a modern diesel maintenance depot.

Employ them too as industrial units or factories – there are, in fact, no limits to the many ways this versatile kit can be used.

The all plastic pre-coloured parts render painting optional. There are opening doors at both ends, finished with correct high visibility diagonal black and yellow stripes.

Manyways Train Shed Unit Kit LK-80

Size of unit: 349mm (13⁷/₁₆in) long
168mm (6⁵/₁₆in) wide
Spans two tracks (not supplied).
Easy assembly – fully illustrated instructions included.

Six kits together make an impressive building



Each kit includes extra special frame structure components for use when building additional units



LK-80



The illustration shows the Office Buildings used in conjunction with the Train Shed Unit LK-80 above



LK-81

OFFICE BUILDINGS

This is truly a 'Manyways' kit, for you have a choice of two each of eight different wall sections to assemble around two oblong bases and roofs. The plastic pre-coloured parts require no painting.

Several kits can be used together to make an office building to practically any size you require.

Fully illustrated assembly instructions included.

Office Buildings Kit LK-81
Size of each unit 114mm x 57mm (4¹/₂in x 2¹/₁₆in).
(kit contains 2 units):



LK-20X

An impressive covered market or loading area can be built using just one kit.



'MANYWAYS' OVERALL ROOF KIT

LK-20X

A superb kit of fully detailed pre-coloured and clear moulded plastic components to form an arched type glazed overall roof.

As the name 'Manyways' suggests, this kit can be assembled in many different ways, end-to-end and side-by-side, mounted on the platform, on the ground, or one side on a

platform and the other on the ground.

Its versatility also extends to its use for non-railway buildings such as a covered market, shopping precinct and an imposing awning over an hotel entrance.

You can even use it vertically to represent a modern glass office block – the possibilities

are almost endless.

The kit contains sufficient parts to build a single span measuring 431mm (17in) long x 184mm (7¹/₂in) wide or 216mm (8¹/₂in) long x 368mm (14¹/₂in) wide if formed into two spans side by side.

GOODS DEPOT KIT

LK-82

An easy to assemble detailed correct colour moulded plastic kit to build a modern concrete and brick type Goods Depot or Loading Bay, 309.5mm (12³/₁₆in) long.

It provides covered loading and unloading facilities between rail and road.

Various accessories are included in the kit for use as wagon loads or to add interest on the platform. The actual selection may vary.

Accessories are included with the Goods Depot for use as wagon loads or to add interest on the platform. They include such items as a Cable Drum, Sewer Pipes, Barrels, Sacks, Asbestos Sheets and Mail Bags.

The actual selection may vary.



LK-82

SIGNAL BOX KIT

LK-83

Despite its modern appearance, the prototype for this superb Peco kit was built back in the '50s, making it equally suitable for use on a British Railways steam era layout or one with modern British Rail diesel and electric locomotives.

Assembly is simple and the correctly coloured components make up into a highly realistic model without the need for any painting.

Size of base (including steps): 79x 85mm (3¹/₈ x 3³/₁₆in).

Fully illustrated instructions included.



LK-83

SUBWAY STAIRCASE KIT

LK-7

Designed to fit into the platform top without the need to cut a hole in the baseboard, this subway will enhance any modern passenger station.

The kit contains parts to make two subway staircase units which can be modified to form one of greater depth if required.

Although designed primarily for use on stations, the 20th century townscape provides many other opportunities for using this versatile kit such as, an underpass, public conveniences, road junction or tourist attraction (even Stonehenge has a subway!).

It can also be used upside down to form steps for entrances to buildings etc.



LK-7





'MANYWAYS' STATION BUILDINGS SERIES

COUNTRY STATION BUILDING KIT

As the name 'Manyways' suggests, this beautifully detailed kit can be assembled in a variety of ways – the toilet block, for example, can be placed at either end of the building. Likewise, the canopy can be mounted on either of the long walls.

For larger, more important stations it can be extended with a second kit (see fig.2) or combined in a variety of ways with the Station Houses kit (LK-15), (see fig.1).

All components are moulded in appropriate colours making painting optional.

Complete with illustrated instructions.

Brick type LK-12
Stone type LK-13

STATION HOUSES KIT

Designed to match the Station Building LK-13, these Houses can be used on their own or as part of a station complex (see fig.1).

Two or more houses together will make a small suburban type terrace, see fig.3.

All components are moulded in appropriate colours making painting optional.

Complete with illustrated instructions.

Brick type (2 per kit) LK-14
Stone type (2 per kit) LK-15

PLATFORM SHELTER AND HUT

Two essential small buildings to complete your station scene or for use on their own.

Two kits back-to-back can be used to build a double shelter (as shown in fig.4) which is

suitable for use on an island platform.

This kit has many uses both on and off railway property, besides providing a variety of useful parts with which to make your own buildings.

All components are moulded in appropriate colours making painting optional.

Complete with illustrated instructions.

Timber type LK-16

BUILDING COMPONENTS

Selections of finely detailed, moulded self-coloured parts to enable modellers to incorporate super detail into their own



LK-15



LK-14



Fig. 3



LK-16



Fig 2



Fig 4



LK-13



Fig 1



LK-12



LK-78 & LK-79

scratch-built buildings without much of the extra work this would normally entail.

Building Components Kit LK-78
Windows, doors, gutters, downpipes, stanchions, bench seat and ventilator.

Building Components Kit LK-79
Slate roofs, ridge tiles, flat roofs, notice boards and chimney stacks & pots.

TUNNEL MOUTHS**Stone type**

Vacuum moulded plastic Tunnel Mouths ready painted in realistic dark stone colour together with smoke/sooty stains represented over the centre of the arches for extra realism.

Modelled on typical British prototypes with correct fine stonework detail. The separate wing/retaining walls can be positioned at varying angles to suit the surrounding landscape.

1 Single Track Tunnel Mouth and 2 walls LK-31
W. 150mm (6in) H. 97mm (37/8in) Wing L. 100mm (4in)

1 Double Track Tunnel Mouth and 2 walls LK-32
W. 225mm (87/8in) H. 105mm (4 1/4in) Wing L. 100mm (4in)

ROAD BRIDGE SIDES**Stone type**

Vacuum moulded painted plastic simulated Stone Road Bridge Sides with detailing to match the Tunnel Mouths. Modelled on typical British prototypes and supplied with separate wing/retaining walls.

The packs contain one side with two retaining walls and walling for above roadway with capping stones. Road decking is not included as this can vary according to the width of road required on the layout.

1 Single Track Bridge Side and 2 walls LK-33
W. 198mm (73/4in) H. 105mm (4 1/4in) Wing L. 100mm (4in)

1 Double Track Bridge Side and 2 walls LK-34
W. 247mm (9 11/16in) H. 105mm (4 1/4in) Wing L. 100mm (4in)

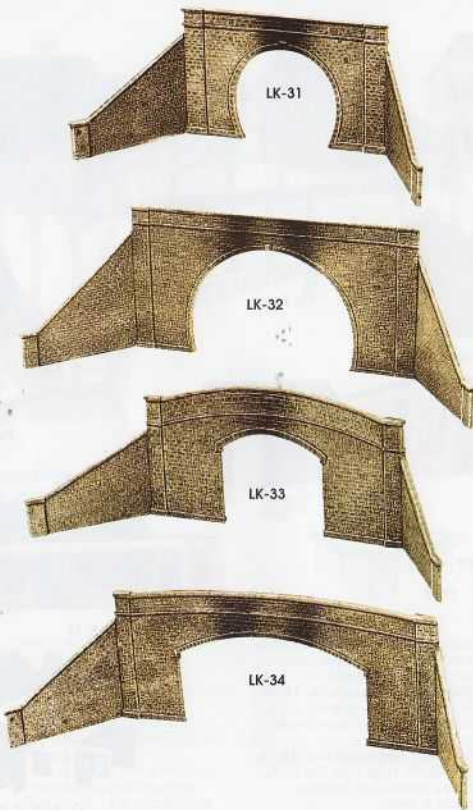
**STONE WALLING**

(Also suitable for other scales)

LK-40

Detailed vacuum moulded plastic simulated stone walling sheets to match the Tunnel Mouths and Road Bridge Sides.

A product that has many uses, including abutments, boundary walls and buildings of various types.

Each sheet measures approx. 184mm (7 1/4in) high by 238mm (9 3/8in) wide.

The complete Road Bridge illustrated (Fig. 1) consists of two single track Bridge Sides and Walls plus Stone Walling Sheet for the arch and card for the roadway.

PLATFORM EDGING

The injection moulded Platform Edging, as used in the Setrack Platform System (page 26), is available separately to build platforms to suit any situation such as those on a curve.

The brick & stone types have printed self-adhesive strips that are easily applied to the mouldings.

Brick type Platform Edging LK-60

Stone type Platform Edging LK-61

Concrete type Platform Edging LK-62

Brick type Platform Ramp Edging LK-66

Stone type Platform Ramp Edging LK-67

Concrete type Platform Ramp Edging LK-68



LK-40



Fig. 1

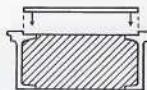
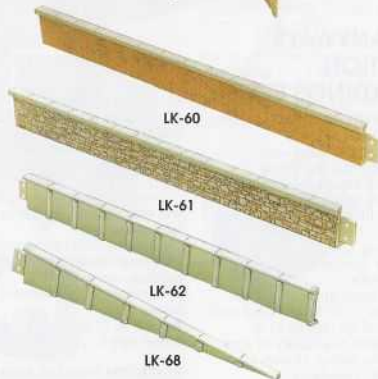

Fig 2

The cross-section diagram (Fig 2) shows the method of construction recommended. Any suitable thickness card or plastic sheet can be used for the platform surface. Straight sections are 168mm (6 5/8in) long and Ramp Sections 113mm (4 7/16in) along the base.



FLEXIBLE FIELD FENCING SYSTEM

LK-45

A revolution in lineside realism, this unique fencing for OO/HO will follow the landscape contours in a prototypical manner with the posts remaining vertical regardless of the terrain.

Moulded in 'weathered' colour plastic with square posts and correct section triangular rails.

Supplied in packs of five sprues, each unit plugging into the next to make a total length of 1066mm (42in). Also available for N and O gauge.



LK-45

FIELD GATES, STILES AND WICKET GATE

LK-46

To complete the Flexible Fencing System, a further pack contains 2 Field Gates, 2 Stiles and a Wicket Gate. All parts are finely detailed plastic mouldings - the Field Gates even include the hinge plates, bolt heads and spring catch on them.

The fencing rails plug into the gateposts whilst the Stile components easily plug together and include a spare post for one side.

The Wicket Gate is assembled on a small base - see illustration.

Perspective modelling

The smaller sizes of Fencing and Gates can be used in the background of your landscape to create an illusion of greater distance. For example, N fencing can be used at the back of an OO/HO layout as shown in the illustration above



LK-46

GIRDER BRIDGE SIDES

PLATE GIRDER BRIDGE SIDES

LK-10

Finely detailed injection moulded Plate Girders with channels provided for fitting to the track deck.

As supplied they should be used 'upright', however, by recessing the rounded ends into the 'stonework' they can then be used under-slung to support the track.

Two or more pairs can be used end-to-end to form an impressive viaduct across a river or valley.

The necessary supporting piers can be made from wood and faced with Peco Stone Walling (LK-40, see page 78). Length: 222mm (8.74 in)

TRUSS GIRDER BRIDGE SIDES

LK-11

Superbly detailed plastic injection mouldings that even include the bolt heads.

These Bridge Sides are supplied in pairs and can be attached to each side of the track bed to span roads, rivers or other railway tracks.

They can be used, either upright or underslung. Two or more can be used, end-to-end, either way up, to extend the bridge span or make an impressive viaduct.

The necessary supporting piers can be made from wood and faced with Peco Stone Walling (LK-40, see page 78). Length: 222mm (8.74 in)



LK-10



LK-11



Several kits end-to-end can be used to build an impressive viaduct.

LEVEL CROSSING GATES LK-50

This attractive set of two pairs of gates with Wicket Gates for pedestrians are finely detailed replicas of the type used throughout the steam era, some of which are still in use today. The gates with their red warning discs are hinged on their posts and give double track spacing when in the closed position across the tracks.

Length 100mm (4ins)

LEVEL CROSSING BARRIERS LK-51

Essential on a modern layout, with their dummy warning lamp standards. Include side fences.

They can also be used with the Setrack Level Crossing System, see page 25.

Length of barrier 50mm (2ins)

WATER TOWER LK-1

A common feature during the steam era. Particularly suited to small loco depots and branch line termini. Six parts; tank top and hose black, other parts dark grey (2 per pack).

WATER CRANE LK-2

Free-standing type used mainly in locomotive yards and at the ends of platforms. Three parts; the upright post in metallic grey with light grey crane and hose (2 per pack).

COAL STAIFTHES LK-3

Once found in almost every station yard. Complete moulding in dark brown with printed paper name panel.

PLATELAYER'S HUT LK-4

A common feature; sited alongside the track. Eight part kit; main wall moulding dark brown, remainder all light grey. Length 40mm (1.5ins)

COAL OFFICE LK-5

Many merchants had small offices in goods yards but this building can be used by a variety of trades. Four parts; one piece wall and chimney moulding in concrete colour, light grey roof and clear plastic for windows. Length 50mm (2ins)

BOOKSTALL LK-6

No station of any importance is complete without a bookstall. Four parts and printed paper colour strips for books, etc.

One piece wall and counter moulding in brown, grey roof and two clear plastic showcase covers.

CHOCOLATE MACHINES LK-21

Used to be found on most stations. Six in a pack, three red and three green. The window panel showing quantity of bars in stock should be painted silver.

WEIGHING MACHINES LK-22

Pack contains four weighing machines - two for people and two parcel type. One of each in red and green. Two parts per machine plus printed paper dials.

MILK CHURNS LK-23

Useful not only on or around the station and goods yard, but on farms etc. 24 complete plastic mouldings in realistic silver colour.

PACKING CASES LK-24

Most useful to add a touch of realism around the station and goods depot area. One each of 6 sizes supplied with separate lids. Natural wood colour.

PLATFORM SEATS LK-25/26

Essential items that should be provided for passengers on every station platform. 12 per pack, available in green (LK-25) or red (LK-26) moulded plastic.

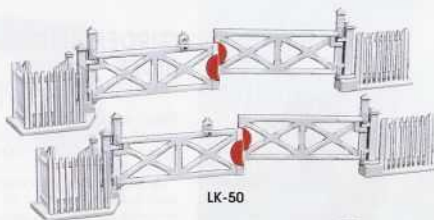

LK-50



LK-51



LK-4



LK-2



LK-1



LK-6



LK-25/26



LK-23



LK-5



LK-24



LK-21



LK-22



LK-3



FLEXIBLE FIELD FENCING SYSTEM

FENCING LK-745
7mm scale for O and O-16.5 gauges

This super detail flexible fencing is the last word in lineside realism for it will follow the landscape contours in perfect prototypical manner with the posts remaining vertical regardless of the terrain.

The brownish plastic mouldings give an authentic 'weathered' appearance.

Available in packs of five sprues making an overall length of 597mm (23 1/2in).

FIELD GATE LK-746

This matching 'field' gate can of course be used in many situations besides the entrance to a field, eg. as a farmyard gate or entrance to a large country house.

The finely detailed moulding includes hinge plates, bolt heads and even the spring catch.



LK-745

The gate post incorporates slots into which the fencing rails plug.



LK-746

Perspective modelling

The smaller sizes of Fencing and Gates can be used in the background of your landscape to create an illusion of greater distance. N and OO/HO fencing can be used at the back of an O gauge layout as demonstrated in the illustration above.

ROAD BRIDGE SIDES

Stone type

Vacuum moulded plastic, simulated stone Road Bridge Sides. Realistic painted dark stone colour together with smoke/sooty stains represented over the arches for extra realism.

Modelled on typical British prototypes with correct fine stonework detail. The separate wing/retaining walls can be positioned at angles to suit the landscape.

The packs contain one side with two retaining walls and walling for the above roadway with capping stones. Road decking is not included as this can vary according to the width of road required on the layout. **Single track Road Bridge side and 2 walls** LK-733

Width: 350mm (13.77ins)

Height: 180mm (7.08ins)

Wing Length: 170mm (6.69ins)

Double track Road Bridge side and 2 walls LK-734

Width: 385mm (15.15ins)

Height: 180mm (7.08ins)

Wing Length: 170mm (6.69ins)



LK-733



LK-734

TUNNEL MOUTHS

Stone type

Vacuum moulded Plastic Tunnel Mouths with detailing to match the Road Bridge Sides.

Supplied ready painted in realistic dark stone colour together with smoke/sooty stains represented over the arches for extra realism.

Modelled on typical British prototypes with correct fine stonework detail.

The separate wing/retaining walls can be positioned at varying angles to suit the landscape.

Single track Tunnel Mouth and 2 walls LK-731

Width: 280mm (11ins)

Height: 178mm (7ins)

Wing Length: 170mm (6.7ins)

Double track Tunnel Mouth and 2 walls LK-732

Width: 380mm (15 1/2ins)

Height: 195mm (7.67 ins)

Wing Length: 170mm (6.69ins)

PETITE PEOPLE

7mm scale for O and O-16.5 gauges

These beautifully proportioned miniature cast white metal figures will bring life and interest to your layout.

The passengers are all suitably posed to populate your station platforms etc. whilst the workmen are modelled to add some 'action' to the scene.

Supplied unpainted.

For greatest realism matt paints (not supplied) are recommended.

Petite People, Passengers (6)
OP-10

Petite People, Workmen (6)
OP-11

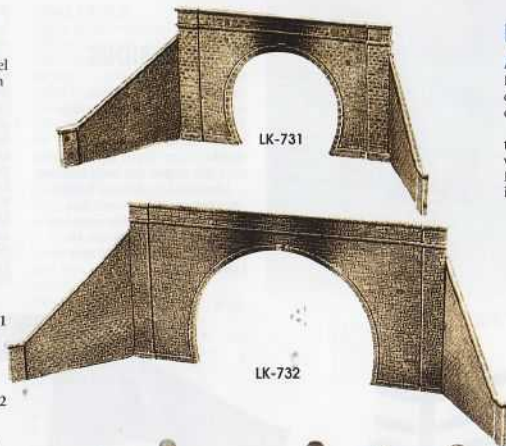

OP-10



OP-11

PLATFORM ACCESSORIES

No period station platform is complete without some of these delightfully produced models.

Accurately cast in white metal, they are all faithful replicas of well known items of yesteryear. Many of these once common items are still to be seen on the

platforms of railways run by preservation societies.

Available unpainted in five sets as illustrated - each set comes with full painting instructions.

Milk Churns, set of 6 LK-751
Porter's Trolley and Luggage LK-752

4 Wheel Platform Trolley LK-753

Sweet & Chocolate Machines LK-754

Platform Ticket Machine, Weighing & Label Machines LK-755



LK-753



LK-751



LK-755



LK-754



LK-752

MATERIALS TO BUILD REALISTIC TERRAIN IN ALL SCALES

Peco Scene scatter materials enable you to model fields and grass slopes, to represent a variety of colourful pastures including meadows, mixed flower, poppy and mustard fields, various crops, moorland etc. The names given to the colours suggest only some of their uses – we are sure you will find many more. For even greater variety, and to add to the realism, the colours can be mixed or 'blended'. Diluted PVA adhesive is recommended for use with these materials.

Hedgerows, trees and bushes can be made from Peco Spring and Autumn Lichen packs, whilst Rock Faces, Boulders, Fine and Medium Ballast packs give you all you require when modelling rock and stony areas.

Peco Scene Materials are in fact suitable for all forms of landscape modelling, not solely for model railways. They can be used for low relief landscape pictures.

SCATTER MATERIAL

Road Grey	PS-1
Path Grey	PS-3
Dark Earth	PS-5
Light Earth	PS-7
Moorland Grass	PS-9
Meadow Grass	PS-11
Spring Grass	PS-13
Mustard or oil-seed rape Fields	PS-15
Poppy Field	PS-17
Flower Field	PS-19

LICHEN

An ideal material for making trees, hedgerows, bushes, garden shrubs etc.

Available ready dyed in two colours.

Spring green foliage PS-21

Autumn brown foliage PS-23

NATURAL STONE BALLAST

For maximum realism you can't beat the real thing! This specially prepared stone ballast will not only add superb realism to your trackwork but will have many other uses around the layout.

Care should be taken to ensure it doesn't foul point blades or get into locomotive mechanisms. Use diluted PVA adhesive to keep it in place.

Grey Stone, fine grade* PS-26

Grey Stone, med. Grade† PS-27

Brown Stone, fine grade* PS-28

Brown Stone, med. grade† PS-29

Buff Stone, fine grade,* PS-30

*Suitable for N, OO & HOm etc.

†Suitable for OO & O

CORK PRODUCTS

Cork is an ideal material for representing rock faces, outcrops of rock, forming spectacular waterfalls and as boulders to be strewn about moorlands and hills or scattered in quarries and at the base of cliffs etc.

Cork's light weight is an added advantage when using it on portable layouts.

PS-37 can also be used to



PS-1



PS-13



PS-26



PS-3



PS-15



PS-27



PS-5



PS-17



PS-28



PS-29



PS-7



PS-19



PS-30



PS-9

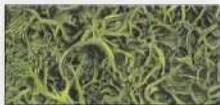

PS-21



PS-37



PS-11



PS-23



PS-39

good effect for flower arranging – if anyone in your family has an interest in that particular hobby it will be best kept out of sight until firmly in place on the layout!

Rock Face, natural cork colour PS-37

Boulders, natural cork colour PS-39

Imitation coal, black PS-41

LANDFORM

A plaster impregnated cloth which makes it easy to model your landscape, all you need is to add water. Instructions included. Approx. 2.7m x 15cm (9ft x 6in)



PS-41

ADD COLOUR AND 'DEPTH' WITH THESE COLOURFUL BACKGROUNDS

A series of full colour, authentic backgrounds, beautifully printed in full colour.

The scenes are all designed so that almost any sheet can be joined to any other to form a continuous and varied background*.

The range includes a variety of countryside plus town, village, city and dock scenes. In addition, sky sheets are available in the large size – one with clouds and one without.

Vary the scene to suit your layout

A special conversion sheet, from which sections can be cut out and superimposed onto other sheets, adds to the variety and flexibility of the range. All sheets are produced in two

sizes, some in three sizes – to suit different scales, perspective and size of layout.

Creating 'distance'

The small size series (some sheets only) can be used to give a greater effect of distance – this is particularly useful for N gauge. They can also be used with the larger scales according to how you plan the perspective appearance of your layout.

The small scenes are the same height as the medium sheets and they can therefore be used together as illustrated on page 87.

* Exceptions to this continuity are the City Centre, Old Town Centre, Dock Centre and Market Town sheets

which are all designed to be joined to

their respective extension sheets to give the much longer length required for these large subjects.

Where space is limited however, this can be varied by using the conversion sheet SK-14 to disguise the joins.

With a little imagination and a pair of scissors or craft knife, the scope using these sheets is virtually endless.

Scenic Background sheet sizes:

Small 178mm x 343mm

(7in x 13½in)

Medium 178mm x 559mm

(7in x 22in)

Large 228mm x 737mm

(9in x 29in)

Sky Sheets 228mm x 737mm

(9in x 29in)



Market Town

Medium SK-49

Large SK-29



Market Town Extensions *

Medium SK-50

Large SK-30

JOIN THE BACKGROUNDS IN ANY ORDER* TO SUIT YOUR LAYOUT



The Market Town sheet used with the extensions sheet makes an ideal background for a busy branchline.



Mountain Lake

Small SK-61

Med. SK-31

Large SK-11



Mountainous Landscape

Med. SK-33

Large SK-13



City Centre

Med. SK-37

Large SK-17



Town

Small SK-66

Med. SK-36

Large SK-16



Old Industrial Town Extensions

Med. SK-46

Large SK-26



Dock Extensions

Med. SK-41

Large SK-21



Country/Seascape

Med. SK-43

Large SK-23



Country Landscape

Small SK-62

Med. SK-32

Large SK-12



Village

Small SK-65

Med. SK-35

Large SK-15



Country with River

Med. SK-44

Large SK-24



City Extensions

Med. SK-38

Large SK-18



Sky with Clouds

Large SK-19

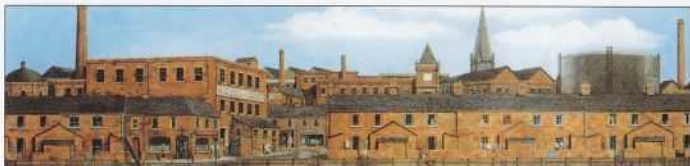

Old Industrial Town Centre

Med. SK-45

Large SK-25



Sky, clear

Large SK-28



Dock Centre

Med. SK-40

Large SK-20



Conversion Landscape

Med. SK-34

Large SK-14

SCENIC BACKGROUNDS *continued*

SMALL AND MEDIUM SHEETS CAN BE COMBINED TO CREATE EXTRA 'DEPTH'



SK-32

SK-65

SK-33

The Small sheets are the same height (178mm) as the Medium sheets, thus they can be used together to give a greater sense of distance.



SK-32

SK-35

SK-33

SK-66

SK-31

CARD KITS

OO/HO COACH INTERIORS & BRIDGE

COACH INTERIOR
KITS

Add that extra realism to OO/HO gauge coaches. Printed on good quality card, these interiors not only include full authentic colour detail, but are strong and light in weight

adding very little to the load.

The detail includes luggage racks, magazines, newspapers, passengers, luggage and even the fittings for the toilet compartments.

Originally designed to fit Kitmaster™ coaches, they are easily adapted to suit other

makes, or for substituting for the often plain colour moulded interiors.

Detailed instructions are included.

Corridor Composite	13
Corridor Second	14K
Corridor Open Second	14SO
Corridor Brake Second	15

TWO-ARCH
BRIDGE KIT

OO/HO, OO-9 and O-16.5 SK-1
Printed in full colour on stout card, this economically priced kit makes up easily into a realistic feature suitable for any OO/HO, OO-9 or O-16.5 layout. It can be used in a variety of ways to span rail, road or river.

Apart from use on permanent layouts, the kit includes approach slopes which make it ideal for use with Peco OO/HO Setrack, Hornby™ etc.



This delightful diorama illustrates the realism that can be achieved using the Two-Arch Bridge Kit.



Length (excluding slopes): 190mm (7½in).



Printed in full colour, the compartment walls have realistic 'wood-grain' finish, whilst the seats are 'covered' in appropriately patterned 'fabrics'. Compartment windows are pre-cut, making assembly much quicker than if these all had to be cut out by hand.

UNDER ONE ROOF



Ratio and Wills bring you the best and biggest selection of British type plastic model railway kits.



When you are in the area on pleasure or business, you are invited to visit our modern showroom and retail shop. We stock a comprehensive range of model railway products from several manufacturers.

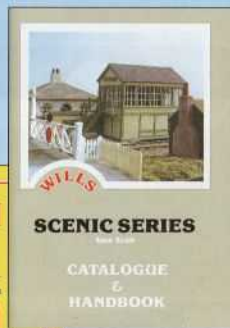

RATIO HOUSE · MARDLE WAY · BUCKFASTLEIGH · DEVON · TQ11 0NR
Telephone: 01364 642764 Fax: 01364 644466

Pecorama

Gardens Games and Trains

FOR THE WHOLE FAMILY

Don't forget, Pecorama is the place for model railway inspiration, gardens of excellence and fun for all the family. Celebrate this new Millennium by arranging a visit soon, ask for a leaflet today,

Tel: 01297 21542 or send sae to Pecorama, Underleys, Beer, Nr. Seaton, Devon EX12 3NA

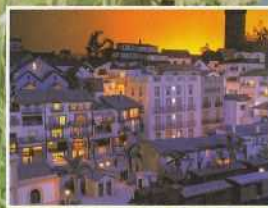
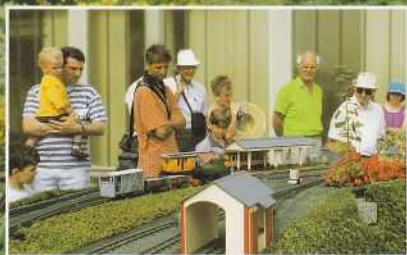

A **PECO** PRESENTATION

PECO



British Made

MAKE SURE A PRICE LIST IS INCLUDED WITH THIS CATALOGUE