



**MODEL
RAILWAYS**

Dapol Limited, Gledrid Industrial Park, Chirk, Wrexham LL14 5DG, United Kingdom
Tel: (+44) 01691 774455 Fax: (+44) 01691 778866 e-mail: sales@dapol.co.uk www.dapol.co.uk

AWARD-WINNING INNOVATION IN 'N'
and **DELIVERING OUR PROMISES**

ANNUAL *Free* **CATALOGUE**

2008

**Manufacturers and Suppliers of
Ready to Run**

**Locomotives
Wagons
& Coaches**

———— and famous ————

**Self Assembly
Plastic Kits**

British



& proud of it!

thank you.....

On behalf of the Dapol team can I thank you all for your support over the past years.

It is difficult to believe that 2008 sees the 25th anniversary of the formation of the company and it's now 10 years since the "new" Dapol management started. I suppose that we should now stop calling it the "new" team!

Looking back over some management minutes, I cannot believe that it was only in 2003 that Dapol decided to enter into N-gauge products and put Warley 2004 as the official 'launch'. I remember the look on the faces of other directors when I told them that Dapol should stop what it was doing and to direct its energies into the smaller scale. For a business that was doing 'very nicely thank you' for someone to say we should stop and turn through 180° - well it was a monumental leap of faith - and especially so because, at that time, nobody in the "new" team had EVER designed a locomotive from scratch. Boy, did we have to learn quickly!

Over the past four years of 'N' we really have worked hard to develop the products, not just in the level of accuracy and body characteristics but in the various working mechanisms. Indeed 2008 is somewhat of a milestone for us. It sees us launch our first 'low-friction' mechanism as well as developing our first exclusive Dapol-only motor. We know that its specification of 5-pole acute-angle skew-wound design is the most powerful ever available for British outline and enables us to design mechanisms around the motor and not, as in the past, designing mechanisms restricted by the limitations of an off-the-shelf motor.

It is because of these increased and improved specifications that we are pleased to launch our "**Platinum**" range of locomotives for 2008 and onwards. These products will be easily identified by the bright silver hologram label attached to the outer box. They will be the pinnacle of British 'N' and will feature designs and mechanisms constructed without compromise.



I would also like this opportunity to put on record my thanks to every one of our employees. In all of my years in business I have never met and worked with a more committed group of people. They are Dapol; nothing is too much trouble, even when under pressure.

Finally, I trust that you will appreciate our free 2008 catalogue which is the largest we have ever produced and which shows an ever-increasing and ever-widening range of products. To those customers whose favourite product is not included this year, I can only say "sorry" - but we are here for the long term and I know that we have plans for the next 25 years which should make everyone eventually happy!

With kind regards

George Smith
Chief Executive



our 'Flagship' locomotive for 2008 - the 9F



BR Late crest 92008
Single chimney BR1G Tender

product code: ND-090a



BR Early crest 92002
Single chimney BR1G Tender

product code: ND-090b



BR Late crest 92226
Double chimney BR1G Tender

product code: ND-090c



BR Early crest 92247
Double chimney BR1G Tender

product code: ND-090d



BR Late crest 92050
Single chimney BR1C Tender

product code: ND-090e



BR Early crest 92100
Single chimney BR1C Tender

product code: ND-090f



BR Late crest 92208
Double chimney BR1C Tender

product code: ND-090g



BR Late crest 92231
Double chimney BR1G Tender

product code: ND-090h

9F specification:

- ◆ 5 pole skew wound motor
- ◆ DCC ready (NEM 651 socket + solder tabs)
- ◆ Tender powered locomotive drive mechanism
- ◆ Correctly modelled flange-less centre wheels
- ◆ Super high detailed body
- ◆ 16 wheel pick-up
- ◆ Low friction tender wheels
- ◆ Separate handrails & piping
- ◆ RP25 darkened see-through wheels
- ◆ 10 driving wheels

ready to run 'N' locomotives

Quarter 1 release

the Q1



Southern C11

(with prototypically correct
'forward' tender lettering)

product code: ND-092a

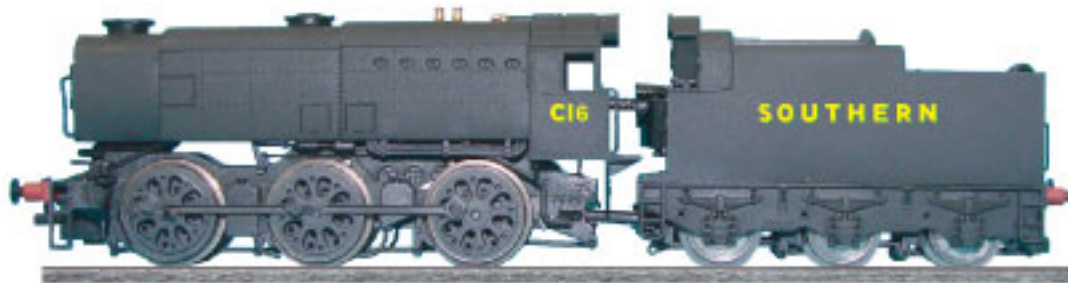

Southern C16

product code: ND-092b

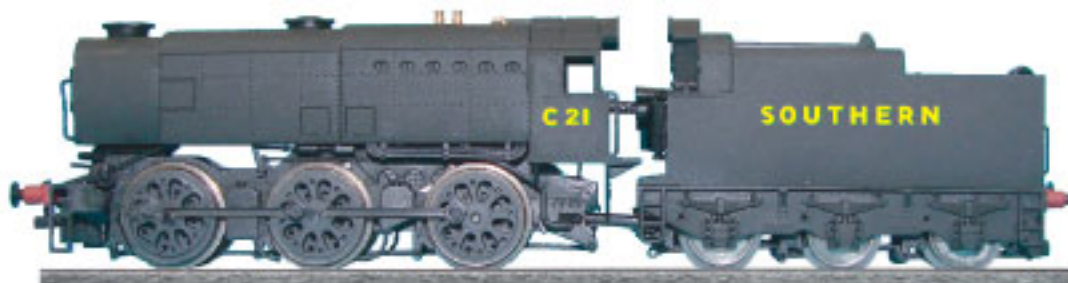

Southern C21

product code: ND-092c

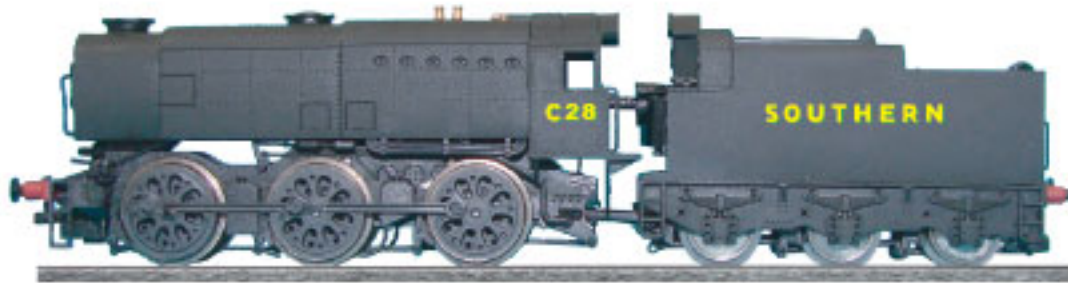

Southern C28

product code: ND-092d

Quarter 3 release

To satisfy customer demand we are
pleased to release this extra 'BR' version



BR Late crest 33002

product code: ND-094

ready to run 'N' locomotives

Quarter 2 release

the B17 'set'

NEW
model



These two B17 in two different liveries will be accompanied by 3 Gresley coaches in the correct livery for the locomotive.

product code: ND-079 Set 1



sorry - no model completed at printing of catalogue

Gresley Teak

First 31879 + Third 364 + Comp 32558



Doncaster Rovers

LNER Lined Green 61657



Artist Impression Only

Darlington

BR Late Crest 61652



Gresley Crimson / Cream

First 11028 + Second 12101 + Comp 10097

product code: ND-079 Set 2

Quarter 3 release

B17 - individuals



sorry - no model completed at printing of catalogue

Grimsby Town

LNER Green 2850

product code: ND-079a



Hull City

BR Late Crest 61660

product code: ND-079b

B17 specification:

- ◆ NEW high-torque skew wound 5 pole Dapol motor
- ◆ DCC ready (NEM 651 socket + solder tabs)
- ◆ Tender powered locomotive drive mechanism
- ◆ 40-1 gearbox reduction
- ◆ Phospor bronze self-lubricating axle bearings
- ◆ Super high detailed body
- ◆ 12 wheel pick-up
- ◆ Low friction tender wheels
- ◆ Etched brass nameplates
- ◆ RP25 darkened see-through wheels
- ◆ Removable coal load

ready to run 'N' locomotives

Quarter 1 release

new release
14xx / 48xx 'sets'

Modified
model

As requested by customers, we have modified the original locomotive body design to incorporate the 'Top Feed' version. The model will be presented with the ever-popular Autocoach; both models have a modified NEM coupling system to achieve a closer coupling than before.

Low price - perfect 'starter set'

**GWR 1466
+ GWR
Autocoach 187**

product code: ND-080 set1



**GWR Shirtbutton
4866 + GWR S/B
Autocoach 190**

product code: ND-080 set2



Ivatt 2MT

Without Push-Pull



ND-062a: LMS Black 1200

Without Push-Pull



ND-062b: LMS Black 1205

Quarter 1 release

With Push-Pull



ND-064a:
BR Black Early Crest 41225

With Push-Pull



ND-064b:
BR Black Early Crest 41271

These are the last in the range that we will make

ready to run 'N' locomotives

Quarter 3 release

the 156 two-car set

NEW
model



First Group 156440

product code: ND-081a
also available:

First Group 156492 non-motorised 'Dummy'

product code: ND-081b

Regional Railways 156418

product code: ND-082a
also available:

Regional Railways 156448 non-motorised 'Dummy'

product code: ND-082b



Strathclyde P.T. 156506

product code: ND-083a
also available:

Strathclyde P.T. 156435 non-motorised 'Dummy'

product code: ND-083b

The dummies can couple to the powered set to create prototypical 'double-headers'.

156 specification:

- ◆ NEW high-torque skew wound 5 pole Dapol motor
- ◆ DCC ready (NEM 651 socket + solder tabs)
- ◆ Below floor mechanism
- ◆ See through windows with internal seating
- ◆ Super close NEM coupling
- ◆ Light switch (to turn off rear light of one car when working in multiple)
- ◆ NEM coupling box with dummy prototypical coupling at each end
- ◆ Directional lighting
- ◆ Low friction mechanism
- ◆ Cab detail
- ◆ RP25 darkened wheels

ready to run 'N' locomotives

Hymek

NEW
model



D7066 BR
Two-tone Green

product code: ND-084a

Magnified view of D7066 showing fitting of air pipes, shackle coupling and snowplough



D7008 showing changes in position of electric flashes from D7066



D7008 BR
Two-tone Green
Alternate deco positions

product code: ND-084b



D7023 BR
Two-tone Green
with full yellow front

product code: ND-084c



D7011 BR Blue
with full yellow front

product code: ND-084d

Hymek with 6 wheel milk tanks

BR Blue D7085 with 6 x individually numbered silver milk tanks - All Weathered

product code: ND-084e



Hymek specification:

- ◆ 5 pole skew wound motor
- ◆ DCC ready (NEM 651 socket + solder tabs)
- ◆ Wire handrails all round
- ◆ Ultra fine injection moulded body
- ◆ Prototypically correct yellow-glow marker light & headcode
- ◆ Low friction mechanism with pinpoint metal wheel bearings
- ◆ Customer added air pipes + snow plough + coupling chain + 8 different headcodes included
- ◆ Heavy chassis for improved haulage
- ◆ Super flush cab glazing
- ◆ Painted cab interior

ready to run 'N' locomotives

class 66 - low emission

DCC plug-n-play ready with automatic bi-directional lighting



Direct Rail Services
ND-069a: 66413 & **ND-069b:** 66417



Bardon Aggregates
ND-068: 66623



Metronet
ND-078a: 66719 -&- **ND-078b:** 66720
(Metro-Land) (Metronet Pathfinder)

class 66 - low emission

Quarter 1 release

Dummy units without lights to create 'double-headers'



Freightliner
ND-085a: 66585



Metronet
ND-085b: 66718

class 66 - original body design

with day / night switchable bi-directional lighting



EWS-i (European) Livery
ND-066a: 66215 & **ND-066b:** 66022

ready to run 'N' locomotives

class 221 - super voyager

4 car set

ND-073a:

221009 'Marco Polo'

ND-073c:

221130 'Michael Palin'

ND-073d:

221144 'Prince Madoc'

ND-073e:

Single Car with Transfer
sheet of numbers



- ✓ **NEW LOW-FRICTION MECHANISM**
- ✓ **NEW SUPER-SMOOTH 5 pole MOTOR**
- ✓ **WORKING LIGHTS**
- ✓ **DCC READY - 6 pin sockets fitted**
- ✓ **UNIQUE MAGNETIC COUPLING**
- ✓ **SUPER-HIGH DETAILED BODY**
- ✓ **ETCHED METAL NAMEPLATE (*Virgin Only*)**
- ✓ **LIMITED to only 250 SETS per name**
- ✓ **+ READY for DIGITAL SOUND CHIP**

Quarter 3 release

class 221 - super voyager

4 car set

ND-087:

Arriva Cross Country

ND-087a:

Single Car with Transfer
sheet of numbers



With sincere thanks to Arriva Trains for the use of their artwork image. Please note this is only an artists impression. The use of the image does not guarantee that this is how any future model may appear, if at all.

ready to run 'N' locomotives

class 73 - twin packs

DCC plug-n-play ready with NEM coupling pockets



ND-070a: Janice 73204 (powered) & Jeanette 73205 (unpowered)



ND-070b: Lisa 73206 (powered) & Alison 73209 (unpowered)

class 73 - singles

Original design - low price - perfect 'starter' locomotive



ND-071: Gatwick Express 73202 'Dave Berry'



ND-072: Gatwick Express 73211

'N' accessories

Coming soon in 2008.....a range of N-gauge accessories including:-



Working Street Lights



People
(painted & unpainted)



Modern Cars
(painted & unpainted)



Trees (assorted)

ready to run 'N' coaches

Gresley coaches - BR maroon

featuring our award-winning close-coupling system + NEM coupling pockets
+ options of buckeye couplings for extra-close coupling, as well as
ultra-high internal body detail unique to British outline and a choice of 9 different
running numbers to allow creation of an accurate prototypical rake

First Class

NC-030a: E11023E

also available

NC-030b: E11020E



All Second

NC-031a: E12279E

also available

NC-031b: E12704E

NC-031c: E12002E

NC-031d: E12071E

Composite Brake

NC-032a: E10077E

also available

NC-032b: E10080E



Buffet

NC-033: E9132E

Collett coaches - GWR Shirtbutton



Composite

NC-034: 7321

Brake

NC-035: 6487



All Third

NC-036: 1080

ready to run 'N' locomotives

Proudly announcing our NEW products for release at Warley 2008

Class 67

ND-088: EWS 67002



Class 67 specification:

- ◆ NEW high-torque skew wound 5 pole Dapol motor
- ◆ DCC ready (NEM 651 socket + solder tabs)
- ◆ Internal cab detail
- ◆ NEM coupling box either end
- ◆ Choice of different NEM compatible couplers
- ◆ Visible brake discs on outer faces of driving wheels
- ◆ Directional lighting
- ◆ Low friction mechanism
- ◆ Customer added buffer beam air pipes
- ◆ RP25 darkened wheels
- ◆ Added front end super detail (jumper cables etc)

Mk 3 DVT

ND-089: ???????



Mk 3 DVT specification:

- ◆ DCC ready (NEM 651 socket + solder tabs)
- ◆ Dapol close coupling system
- ◆ NEM coupling box either end
- ◆ Choice of different NEM compatible couplers
- ◆ Directional lighting
- ◆ Internal cab detail
- ◆ Alternate front air dam
- ◆ RP25 darkened wheels

???



WELL - Warley wouldn't be Warley without Dapol unveiling some kind of 'secret' product!

ready to run 'N' wagons

Ferry Wagons

The models feature our award-winning **CLOSE-COUPLING** system
+ **NEM** coupling pockets + options of buckeye couplings for
extra-close coupling

Each wagon will be limited to 500 units per running number.

All four models in each set have a differently designed decoration to make them prototypically correct



NB-049a: CargoWaggon - 279 7 589-9P

NB-049b: CargoWaggon - 279 7 632-7P

NB-049c: CargoWaggon - 279 7 650-9P

NB-049d: CargoWaggon - 279 7 663-2P



NB-055a: Blue Circle - 279 7 611

NB-055b: Blue Circle - 279 7 613

NB-055c: Blue Circle - 279 7 649

NB-055d: Blue Circle - 279 7 683

Quarter 2 release



NB-065a: CargoWaggon - 279 7 619-4

NB-065b: CargoWaggon - 279 7 661-6

Spine Wagons - twin packs + containers

Each wagon will accept either 1 x 40' plus 1 x 20' or 2 x 20' Containers



NB-062a : Freightliner : 640121 + 122

NB-062c : GBRf : 640603 + 604

NB-062b : Freightliner : 640209 + 210

NB-062d : GBRf : 640619 + 620



NB-063: Pack of 1 x 20' and 1 x 40'

*Packet of mixed liveries for attaching to our Spine Wagons.
Liveries will continually change and packs will contain
different liveries over the years of production.
These containers will also feature 'Opening Doors'
for added realism on any layout.*

ready to run 'N' wagons

Telescopic Steel Hood

The models feature our award-winning **CLOSE-COUPLING** system + NEM coupling pockets + options of buckeye couplings for extra-close coupling and an opening rear panel.

Each wagon will be limited to 500 units per running number.



NB-061a : 589 9 087 6
NB-061b : 589 9 082 7
NB-061c : 589 9 077 7
NB-061d : 589 9 076 9

Quarter 3 release



Artist impression only

NB-066a : 33 80 4667 017
NB-066b : 33 80 4667 023
NB-066c : 33 80 4667 028
NB-066d : 33 80 4667 046

Quarter 1 release

Megafret wagon

'Megarfret' is the generic name of the single 'low loader' wagon which carries a variety of containers. From 2008 onwards we will be making different liveries of containers to compliment the wagon.

NB-067: Basic Megarfret Wagon

Containers

Our first container livery release will be the 'Tesco' design and which has been made to compliment our 'Stobart' Class 66.



NB-067b: Tesco - Stobart 6
NB-067c: Tesco - Stobart 10
NB-067d: Tesco - Stobart 17
NB-067e: Tesco - Stobart 21

ready to run 'N' wagons

Fish vans

The models feature our new **CLOSE-COUPPLING** system with NEM coupling pockets and optional Buckeye couplings. Each wagon will be limited to 250 units per running number.

Blue Spot



NB-051a: E87234
NB-051b: E87228
NB-051c: E87002
NB-051d: E87329

Shirebrook Breakdown Packing Van



NB-052a: ADB 975436
NB-052b: ADB 975402

Due to the unexpected 100% sell-out of 'Shirebrook' at release in Oct 07 we are completing a new production batch during 1st Quarter 2008.

Quarter 2 release

BR Blue



NB-068a: E88005
NB-068b: E88001

BR Barrowhill



NB-069a: ADB 975424
NB-069b: ADB 975417

Dogfish wagon

Quarter 3 release

Each wagon is limited to 250 units per running number.



NB-070a: Enginers Dutch 983587
NB-070b: Enginers Dutch 992958
NB-070c: Enginers Dutch 992961
NB-070d: Enginers Dutch 993314

All models have a differently positioned decoration to make them prototypically correct

7 plank wagons

Each wagon is limited to 250 units per running number.



NB-071:
Bourne Fisher - Wigan



NB-072:
Whitwood - Normanton

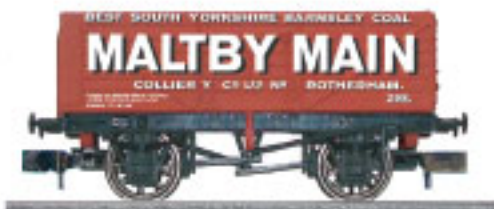

NB-073:
Maltby Main - Rotherham

Quarter 1 release

Quarter 3 release

Quarter 4 release

ready to run 'N' wagons

6 wheel milk tanks

Each wagon is limited to 500 units per running number



NB-044:
Co-op



NB-045:
Milk Marketing Board



NB-053:
Express Dairy



NB-054:
I.M.S.



NB-056:
Co-operative London

20t Mineral wagons

Each wagon is limited to 500 units per running number



NB-040a:
BR - P339354K
also available as
different running numbers
NB-040b + c + d



NB-059a:
GWR loco - 33156
also available as
different running numbers
NB-059b + c + d



NB-060a:
Blaenavon 2438
also available as
different running numbers
NB-060b + c + d

'N' spares

NCOUP: 10 x couplings and springs
NAXLE: 10 x wagon axles
NBOG1: 1 x pair short coupling bogies for B-set coach
NBOG2: 1 x pair Autocoach bogies

NBOG3: 1 x pair class 66 bogie frames - revised design
NCHASS1: 1 x motorised chassis for 14xx
NMOT1: 1 x motor for 14xx
NCHIM1: Chimney, screw and pipes for 14xx

ready to run 'N' wagons

Bulk grain hoppers

Each wagon is limited to 500 units per running number



NB-036a:

BR - B885364

also available as different running numbers
NB-036b + c + d



NB-037c:

Bass Charrington 32

also available as
NB-037d: Bass Charrington 36



NB-042a:

GW Grano - 42302

also available as different running numbers
NB-042b + c + d



NB-043a:

LMS Bauxite - 701351

also available as different running numbers
NB-043b + c + d

21t hoppers

Each wagon is limited to 500 units per running number
and have loose coal loads



NB-038a:

BR - E289595K

also available as different running numbers
NB-038b + c + d



NB-039a:

NCB - 128

also available as different running numbers
NB-039b + c + d



NB-046a:

British Steel

also available as different running number
NB-046b



NB-047a:

House Coal - B421943

also available as different running number
NB-047b

'00' wagons - 2008 releases

January



B718
4 Plank - New Cransley Iron



B719
6 Wheel Milk - MMB



B720
Presflo - Bulk Cement

February



B721
Banana Van - Fyffes



B722
Gunpowder - SR 'Improved'



B723
7 Plank - Flower & Son

March



B725
Presflo - ICI Salt



B726
5 Plank - Cumberland + Granite Load



B727
20t Mineral - Bolsover

April

**NEW
model**

FEA Spine Wagon - Freightliner - All models are TWIN PACKS



B724a - 640121 + 640122 **B724b** - 640209 + 640210 **B724c** - 640213 + 640214 **B724d** - 640353 + 640354

'00' wagons - 2008 releases

May



B728
16t Steel Mineral - ICI



B729
Lime Wagon - White



B730
8 Plank - Littleton Colliery

June

NEW wagon



B731
Rectangular Tank - ICI



B732
6 Wheel Milk - Express Dairy



B733
5 Plank - Hannal Samwel

July

NEW wagon



B734
Grampus - BR



B735
20t Mineral - Cilely



B736
4 Plank - Teign

August

NEW wagon



B737
Fruit 'D' - GWR Shirtbutton



B738
Rectangular Tank - Butler



B739
Presflo - Slate Powder

'00' wagons - 2008 releases

We will also be making a range of Containers for our Spine Wagons copying the same basis as our 'N' models. Updates will be provided over the year.

September

FEA Spine Wagon - GBRf - All models are TWIN PACKS



B740a - 640603 + 640604 **B740b** - 640619 + 640620 **B740c** - 640619 + 640620 **B740d** - 640601 + 640602

October



B741

6 Wheel Milk - Independent Milk Supplies



B742

Grampus



B743

4 Plank - Clee Hill

November



B744

Rectangular Tank - Smith



B745

Fruit D - BR



B746

Fruit D - GRW Large Logo

December

Telescopic Steel Hood Wagon 'VTG'



B747a - 589 9 087 6 : **B747b** - 589 9 082 7 : **B747c** - 589 9 077 7 : **B747d** - 589 9 076 9

ready to run '00' wagons



B341
CCT Utility - SR



B342
CCT Utility - Midland



B345
Banana Van - BR



B348
7 Plank - GWR



B349
Gunpowder - GWR



B388
CCT Utility - BR Southern Region



B500
Cattle Wagon - GWR



B501
Cattle Wagon - BR



B502
Bulk Grain - BR



B503
Bulk Grain - GWR



B504
Fruit Mex - GWR



B507
Blue Spot Fish - BR



B549
Ale Wagon - GWR



B568
7 Plank - BR



B584
Fruit Mex Bauxite - BR

ready to run '00' wagons



B612 b
Saxa Salt



B627
Box Van - SR



B631
9 Plank - BR



B636
Box Van - GWR



B642
Box Van - LMS



B643
12t Hopper - BR



B679
20t Steel - BR



B683
Presflo - Blue Circle



B686
16t Steel Mineral - Bauxite



B693
7 Plank - Joseph Boam
+ Sand Load



B694
20t Mineral - Stephenson Clarke



B697
6 Wheel Milk - Express Dairy



B700
Gunpowder - BR Bauxite



B701
16t Steel Mineral - BR Bauxite



B704
Blue Spot Fish Van - Barrowhill

ready to run '00' wagons



B706
16 t Mineral - Weathered Grey



B707
12t Hopper - Dorman Long



B708
7 Plank - Wm. Thomas - Wellington
+ Brick Load



B709
6 Wheel Milk - Unigate Creameries



B710
7 Plank Weathered - Sherwood



B711
Banana van - Geest # B882128



B712
20t Mineral - GWR # 33152



B713
12t Hopper - Bell Brothers



B714
4 Plank - Weardale



B715
5 Plank - Black Rock



B716
Tropical Fruit - GWR



B717
Lime Wagon - Minera

Unpainted wagons

- A001** - 5 Plank
- A002** - 7 Plank
- A003** - 21t Hopper
- A004** - Vent Van
- A005** - 4 Plank
- A006** - 8 Plank
- A007** - 9 Plank
- A008** - 16t Mineral
- A009** - 20t Mineral



Twin Packs of
Raw unpainted bodies
with
Chassis, Wheels,
Couplings and Load.

self-assembly 'OO' plastic kits

The Dapol factory operates under a 'Green' policy. No plastic is ever 'Thrown Away'. We re-use plastic through a system called 'Re-Grinding'. Our kits are made with 'Re-Grind' plastic and therefore the colours of the plastic will be different between batches. This does not affect the quality or performance of the kit. After four cycles of 'Re-Grinding' any residue plastic is sent to a Re-cycling plant where it is used to form the protective banding around newly planted trees.

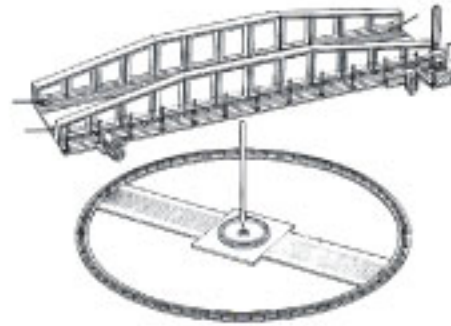

C001: Turntable



C002: Railway Workmen



C003: Girder Bridge



C004: Footbridge

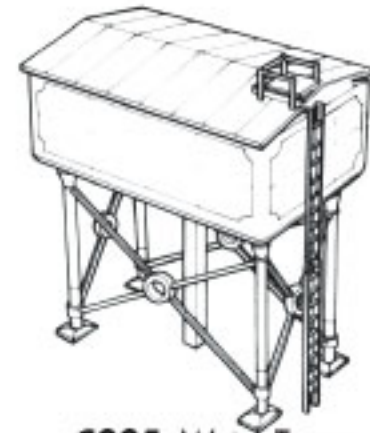

C005: Water Tower



C006: Signal Box



C007: Engine Shed



C008: Platform Figures



C009: Deltic Diesel



C010: Platform Canopy



C011: Platelayers Hut & Office



C013: Platform Fittings



C014: Booking Hall

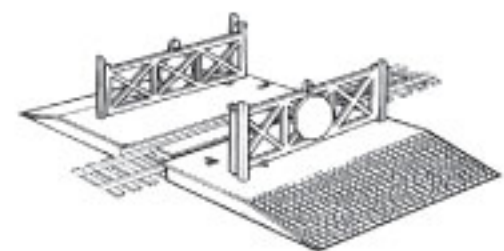

C015: Level Crossing

self-assembly 'OO' plastic kits

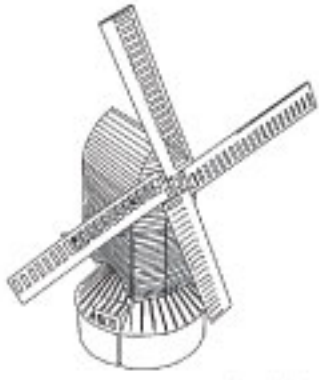

C016: Windmill

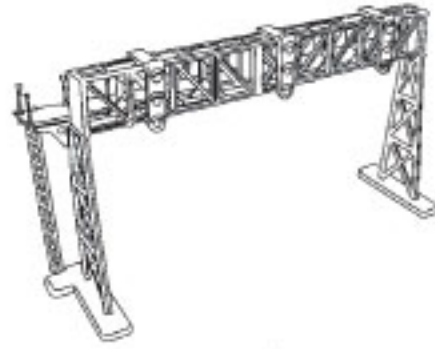

C017: Signal Gantry

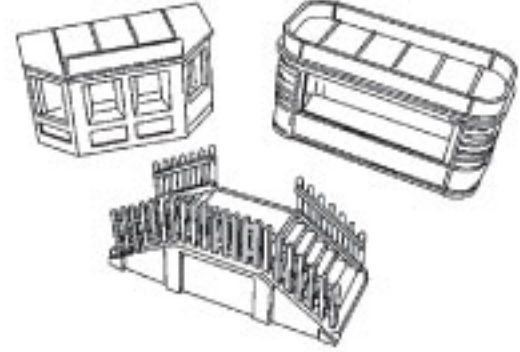

C018: Kiosk & Steps



C019: General Stores



C020: Thatched Cottage



C021: Detached Bungalow



C022: Station Platform



C023: Fences & Gates



C024: Telegraph Poles



C025: Country Inn

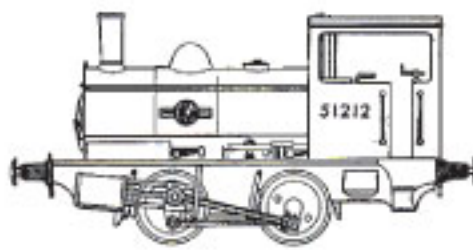

C026: BR Pug 0-4-0



C027: Detached House

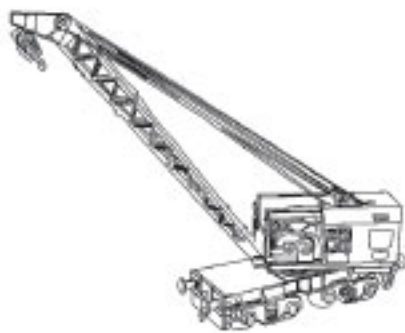

C028: 15t Diesel Crane



C029: Village Church

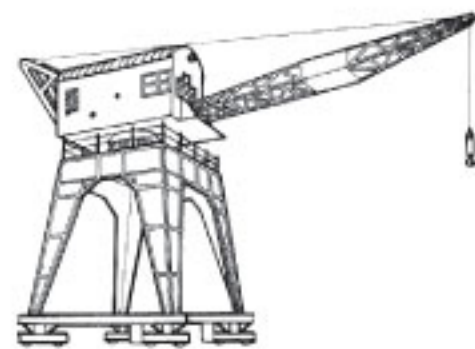

C030: Travelling Dockside Crane

self-assembly 'OO' plastic kits



C031: Shop & Flat



C032: Petrol Station

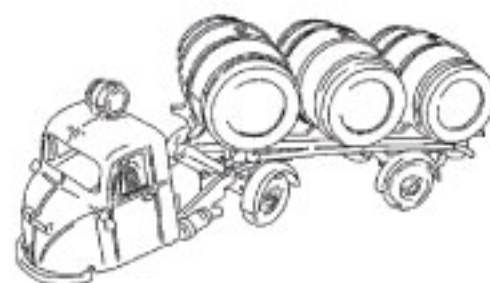

C033: Scammell Scarab

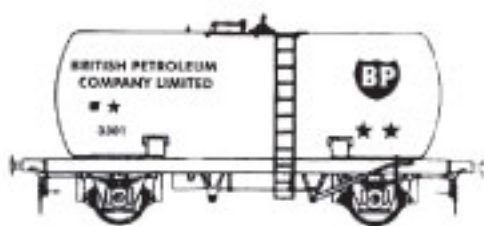

C034: 20T Tanker BP

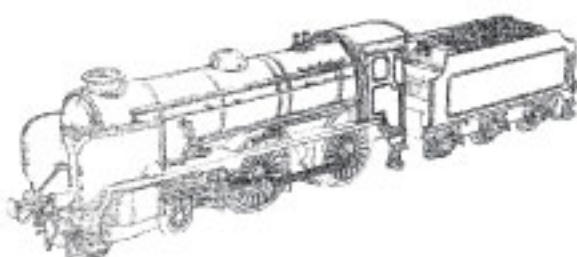

C035 - Schools Class: Harrow



C036: 20T Tanker ESSO



C037: 16T Mineral Wagon

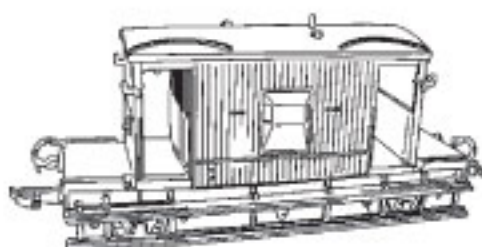

C038: BR Brake Van

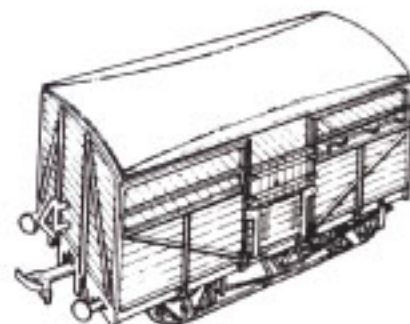

C039: BR Cattle Wagon

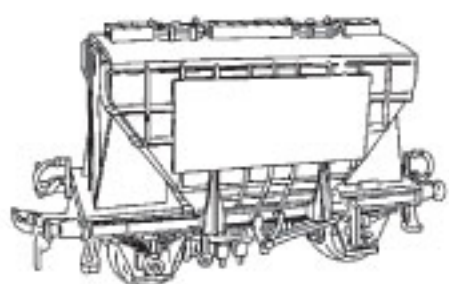

C040: Presflo Cement Wagon



C041: 10T Meat Van



C042: Interfrigo Van



C043: Prestwin Twin Silo Cement



C044: Lowmac



C045: JCB

self-assembly 'OO' plastic kits



C046: Stephensons Rocket

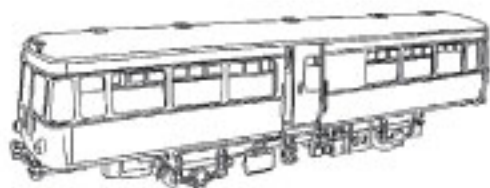

C047: BR Railbus



C048: Battle of Britain - Biggin Hill



C049: Evening Star



C057: Semi-detached House

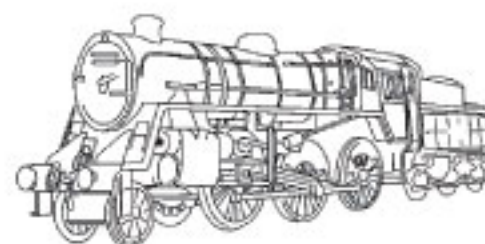

C059: BR Mogul 2-6-0



C060: Drewery Shunter

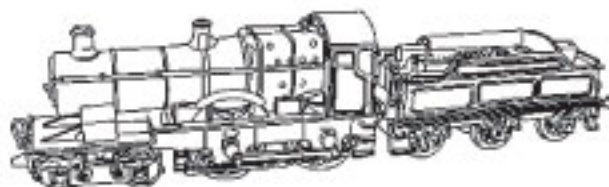

C061: City of Truro 4-4-0

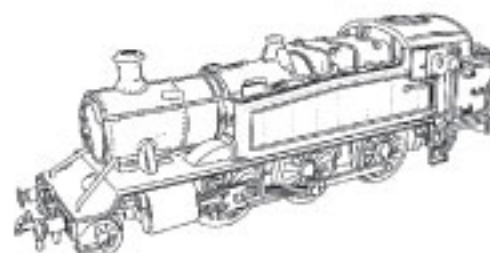

C062: BR Prairie 2-6-2



C073: Village Stocks

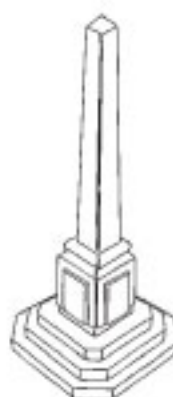

C076: War Memorial



C077: Pub Sign & Trough



C078: Signpost & Stile



C083: Battle of Britain - 257 Squadron



C084: Battle of Britain - 92 Squadron

self-assembly 'OO' plastic kits



C085: Battle of Britain - Fighter Pilot

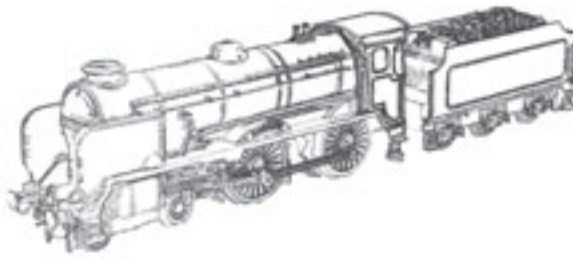

C086: Schools Class - Shrewsbury



C087: Schools Class - Rugby

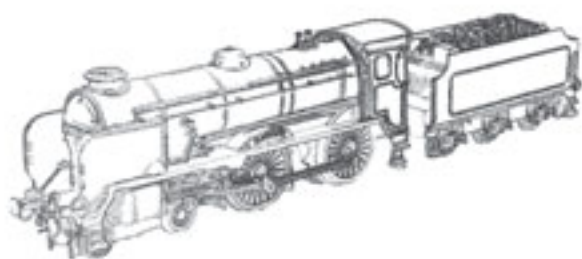

C088: Schools Class - Kings Wimbledon

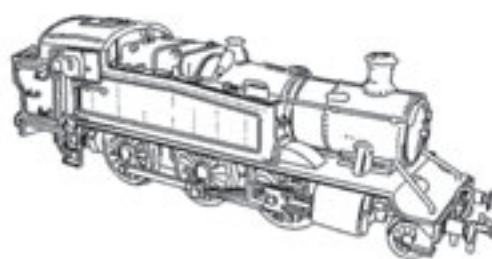

C089: GWR Prairie 2-6-2

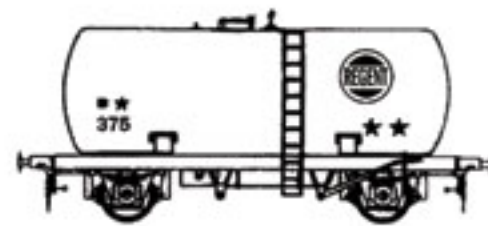

C090: 20T Tanker Regent

'OO' spares

WCHASS10: 1 x 10' wagon chassis
WCHASS11: 1 x 11' wagon chassis
WCHASSHOP: 1 x 21t hopper chassis
WHELDISC: 20 x disc wheels
WHEELSPOKE: 20 x spoke wheels
COUP4: 20 x pairs couplings

RET4: 20 x pairs retaining clips
CONV4: 20 x pairs conversion clips
COAL: 4 x coal loads for 5/7 plank wagons
COAL1: 4 x coal loads for 21t hopper wagon
COAL2: 4 x coal loads for ore wagon
LOAD1: 4 x assorted loads (sand + brick + granite + timber) for 5/7 plank wagons

Special commission wagons + locomotives!

Dapol are the leading supplier of 'special commission' wagons in the UK - and probably the world! Because production is undertaken in the UK, we can set our minimum wagon order level at just 100 units and can offer a delivery time of about 12 weeks from confirmation of final artwork approval.

The good news is that, starting from this year, we can offer a similar service for N-gauge LOCOMOTIVES. Our minimum order level for stock locomotives is just 250 units.

If you are interested in either wagons or locomotives - please contact us. We are here to serve.

Ixion ***Model Railways***

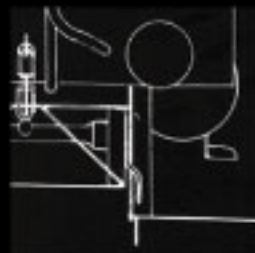
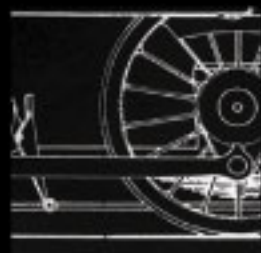

Introducing **Ixion Models**, an Anglo-Australian company formed by three renowned and experienced modellers, with the desire to deliver 'N' scale locomotives to the highest possible standards, based on fastidious attention to detail, and using 'state of the art' manufacturing methods.

We intend to launch our first locomotive during September 2008 at the proposed N-gauge Exhibition near Warwick and thereafter, additional models at six-monthly intervals.

This locomotive will feature:

- ◆ Faithful-to-the-prototype detail, in British N scale 1:148
- ◆ RP25 darkened, see-through spoked wheels
- ◆ High torque 5 pole, skew wound motor in the tender, driving the loco wheels via a Cardan shaft
- ◆ 12 wheel pick-up
- ◆ Etched brass name, factory fitted
- ◆ An included accessory pack featuring:
fire irons, crew figures, lamps and non-working screw coupling for fitting to the coupling hook
- ◆ DCC ready with NEM 651 socket
- ◆ NEM coupler sockets
- ◆ Alternate NEM knuckle couplings

We will be using our website www.ixionmodels.com to provide regular updates on our model progress, and would of course welcome comments from customers, as and when the information is released - details from the "Contact Us" button.

We are delighted to advise that Dapol Ltd have been appointed as the sole retailer of our products for the UK, Europe and the USA.

All sales in Australasia will be handled directly by ourselves via our website and exhibitions. Further details will be provided closer to the release date.

We look forward to supplying 'N' scale modellers with a range of superior models on a global basis for many years to come.

Ixion Model Railways Ltd

Trading address: PO Box 531, Eastleigh, SO53 0EG, United Kingdom Tel (UK): +44 (0) 7775 782086 Fax (UK): +44 (0) 2380 271339
Post (Aust): PO Box 303, Quakers Hill, NSW 2763, Australia Tel (Aust): +61 (0) 2 9626 9273; Mobile 0433 646393
Website: www.ixionmodels.com Email: info@ixionmodels.com

'N' exclusive - Dapol direct sales only

During 2008 Dapol will be manufacturing a small selection of exclusive models that will **ONLY** be available directly from Dapol. The models will be initially offered to members of our N'thusiast club and then, any remaining stock will be opened to the general public.

Product can be acquired from our website or by telephoning our mail-order department.



Quarter 1 release

9F - Evening Star

product code: ND-090



Class 66 - Stobart

product code: ND-067



Quarter 4 release

"Sunderland Special"

Twin Pack : product code: ND-079c



sorry - no model completed at printing of catalogue

Sunderland F.C.

B17 - LNER Green 2854



Sunderland F.C.

Class 66 - 66725

Tomix motorised track cleaner

product code: 6421



This superb product enables the complete cleaning of track. It cleans, vacuums and polishes as it travels the track. It is also DCC Ready



MODEL RAILWAYS

Dapol Limited, Gledrid Industrial Park, Chirk, Wrexham LL14 5DG, United Kingdom
Tel: (+44) 01691 774455 Fax: (+44) 01691 778866 e-mail: sales@dapol.co.uk www.dapol.co.uk

AWARD-WINNING INNOVATION IN 'N'
and **DELIVERING OUR PROMISES**



The following retailers carry stocks of all new monthly products

- | | |
|---|---|
| ABINGDON: Osborn's Models tel:01235 522700 (N) | LEYTONSTONE: The Engine Shed tel:0208 539 3950 (N) + (00) |
| ALTON: Alton Models tel:01420 542244 (00) | LIVERPOOL: Hattons tel:0151 733 3655 (N) + (00) |
| AVIEMORE: Strathspey Railway Co tel:01479 810725 (00) | NANTWICH: Trident Trains tel:01270 842400 (00) |
| BEDFORD: N Gauge Lines tel:01234 261482 (N) | NEWCASTLE EMLYN: West Wales Wagon Works tel:01239 712730 (00) |
| BURTON-ON-TRENT: The Tutbury Jinny tel:01283 814777 (00) | NEWPORT (SHROPSHIRE): A P Models tel:01952 814218 (00) |
| CAMBORNE: Kernow Model Railway Centre tel:01209 714099 (N) + (00) | ROCHESTER: The Signal Box tel:01634 826370 (N) + (00) |
| DARLINGTON: C + G Model Railways tel:01325 381085 (N) + (00) | SHEFFIELD: Tags Modelshop tel:0114 249 5700 (N) + (00) |
| DERBY: Trainlines of Derby Ltd tel:01332 343943 (N) | SHEPTON MALLETT: East Somerset Models tel:01749 880651 (N) + (00) |
| DONCASTER: Tags Modelshop tel:01302 367676 (N) + (00) | SWANSEA: Holt Model Railways tel:01792 232264 (00) |
| KIDDERMINSTER: DMB / Footplate Models tel:01562 750076 (N) + (00) | WARWICK: Castle Trains tel:01926 497905 (N) |

Please visit our website for all the latest news and ongoing product developments



N'thusiasts Club

The Dapol N'thusiasts Club is organised and run for the benefit of modellers in 'N' gauge. Upon joining, your "Welcome Pack" contains quality Club Branded:



N'thusiasts Club

Mug + Enamelled Badge + Pen + Notepad + Members Card with Lanyard + Free Wagon.

During your year of membership you are also offered the following exclusive opportunities:

- * Acquisition of Dapol products not available anywhere else.
- * Invitation to a special 'Members Open Day' at our offices where we entertain you and show you our brand-new and future products before anyone else.
- * Access into a special 'Members Area' within our stand at exhibitions.
- * Access to Dapol stockists who will offer you discounts at their premises.



You can join via our website, by telephone or by mail. We look forward to welcoming you into the Premier UK 'N' gauge club.