

Bachmann Trains



2011



Now that's the way to run a railroad!™

2011

This is an incredibly exciting time to be a model railroader. The array of choices in all scales is rapidly increasing while at the same time the dimensions of electronics to operate trains are shrinking at an amazing rate—all the better to be incorporated into HO and N scale locomotives. Now is the perfect opportunity to experience the thrills of digital command control with your first DCC-equipped locomotive or to complement your collection with our DCC sound-equipped models that feature the highest-quality sound technology (Soundtraxx® Tsunami®) on the market. This catalog puts the whole world of model railroading right at your fingertips.

You can find familiar faces and new friends and accessories in our expanded *Thomas & Friends™* collection in HO and Large Scale. We've added a brand-new destination for your *Thomas & Friends* HO locomotives—Knapford Station.

Bachmann is delighted to offer new DCC-equipped versions of many popular models, including the HO *EMD GP9* diesel and *Alco RS-3* diesel and the N *Baldwin 4-6-0* steam and *GP7* diesel locomotives. Large Scale enthusiasts will want to join us in welcoming updated *2-4-2* and *Baldwin Industrial Mogul 2-6-0* steam locomotives back to the *Big Haulers®* lineup.

Impressive HO *Spectrum®* selections include DCC-equipped and DCC sound-equipped versions of the *Baldwin Modern 4-4-0* and *70-Ton Three-Truck Climax* and the long-anticipated *Birney Safety Streetcar*. These outstanding locomotives and streetcars deserve an equally striking backdrop, which you can supply with the return of our *Cityscenes™* building kits. New *Spectrum®* N scale models, including the *Peter Witt Streetcar* and *GE 70-Ton* diesel locomotive, now feature *DCC ON BOARD™* technology. In On30, *Porter 0-4-2* and *0-4-0* steam locomotives are available in both DCC-equipped and DCC sound-equipped models. Also new to the *Spectrum®* line are the 1:20.3 Large Scale *Two-Truck Climax* locomotives, in both DCC-ready and DCC sound-equipped versions.

The O gauge Williams by Bachmann™ *Traditional Line* and *Golden Memories* train sets, locomotives, rolling stock (including the new *Flatcars with Bulkhead Ends*), and accessories are the perfect way to introduce beloved models from the “golden age” of model railroading to the next generation of hobbyists—and many other generations to come!

So whether you are seeking the cutting edge in digital technology or you want to revisit your favorite locomotives and train sets, we are sure you will discover exactly what you are looking for in the pages of this catalog. Now that's the way to run a railroad!

Bachmann Industries, Inc. is an official licensee of CSX Corporation and is authorized to use trademarks owned and/or registered by CSX Corporation.

Products bearing Union Pacific, Chicago & Northwestern, Denver & Rio Grande Western, Missouri Pacific, Pacific Fruit Express, Rio Grande, Southern Pacific, and Western Pacific marks are under trademark license from Union Pacific Railroad Company.

Table of Contents

HO Scale

Thomas & Friends™	2
Train Sets	13
Specialty Train Sets	28
<i>E-Z Command</i> ® DCC Sets and Accessories	30
Locomotives	38
Other Motive Power	71
Rolling Stock	74
<i>E-Z Mate</i> ® Couplers	93
<i>Plasticville</i> ®, U.S.A. Built-Ups & Building Kits	94
Accessories	98
<i>E-Z Track</i> ® and Accessories	100

N Scale

Train Sets	110
Motive Power	116
Rolling Stock	123
<i>Plasticville</i> ®, U.S.A. Buildings and Accessories	130
<i>E-Z Track</i> ® and Accessories	133

O Scale

<i>Plasticville</i> ®, U.S.A. Built-Ups, Building Kits, and Accessories	136
---	-----

Large Scale Big Haulers®

Thomas & Friends™	144
Train Sets	148
Motive Power	160
Rolling Stock	165
Track, Figures, and Accessories	175

SceneScapes™

Miniature Figures	178
Trees and Grass Mats	181
Landscaping	183

Power Packs and Lubricants

Power Packs and <i>E-Z Lube</i> ® Lubricants	186
--	-----

Spectrum® Products

HO Scale

Train Sets	188
Amtrak <i>Acela</i> ® Models	190
Motive Power	194
<i>Cityscenes</i> ™ Buildings	215

N Scale

Amtrak <i>Acela</i> ® Models	216
Motive Power and Tenders	218

On30 Scale

Train Sets	230
Motive Power	234
Rolling Stock	251
Accessories	261

Large Scale

Motive Power	262
Rolling Stock	277
Accessories	284

Knapford Station

NEW

Item No. 45239 • Standard Pack: 2 • \$121.00

Includes three platforms; two or more kits can be combined to create larger station configurations.



approximately
10.5" wide x 26" long x 6.25 high

Tidmouth Sheds with Manually Operated Turntable

Item No. 45236 • Standard Pack: 2 • \$192.00

NEW

Now you can give your *Thomas & Friends*™ HO scale locomotives a place of their own after a full day's work on the Island of Sodor. Five bays and a manually operated turntable keep engines ready for new and exciting adventures! Tidmouth Sheds can be expanded to include up to twelve stalls by using the Tidmouth Sheds Expansion Pack (Item No. 45238).

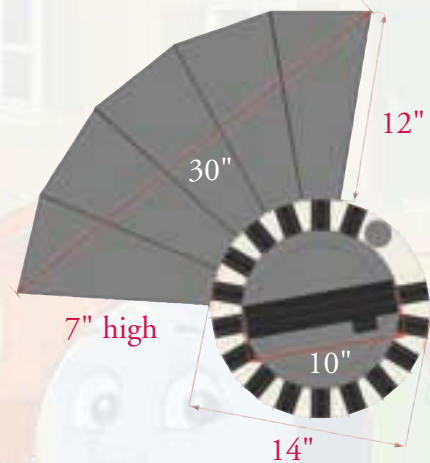
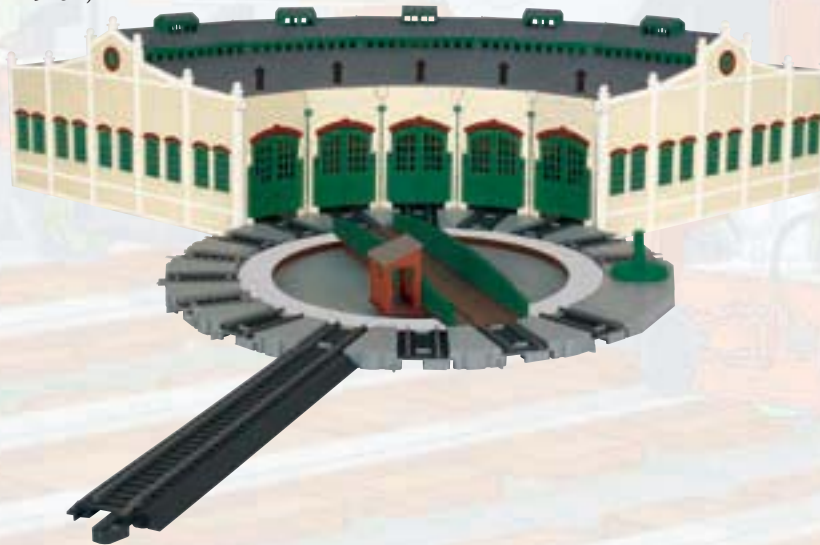

TIDMOUTH SHEDS EXPANSION PACK

Item No. 45238 • Standard Pack: 6 • \$39.00

NEW

Use this expansion pack to add an engine shed to Tidmouth Sheds (Item No. 45236).





Thomas' Eyes
Move Side to Side

Deluxe Thomas & Friends™ Special

an E-Z Track® set

Item No. 00644 • Standard Pack: 3 • \$165.00

Thomas the Tank Engine™ and his coaches Annie and Clarabel have started on a magical journey across the Island of Sodor. Back at the station, Sir Topham Hatt sends Harold the Helicopter and Bertie the Bus to keep an eye on Thomas to make sure he arrives on time. With our *Deluxe Thomas & Friends™ Special* set, you can relive the stories seen in the *Thomas & Friends™* books, television shows, videos and feature films, or create your own railway adventures.

This ready-to-run train set includes:

- Thomas the Tank Engine™ with moving eyes
- Annie coach with international-style hook and loop couplers
- Clarabel coach with international-style hook and loop couplers
- Bertie the Bus
- Harold the Helicopter
- Sir Topham Hatt figure
- 56" x 38" oval of snap-fit E-Z Track® with 12 pieces of curved track, 3 pieces of straight track, and 1 straight plug-in terminal rerailer
- power pack and speed controller
- illustrated instruction manual



BERTIE
the BUS



SIR
TOPHAM HATT



HAROLD
the HELICOPTER



Speed Controller
with Plug-In Wiring

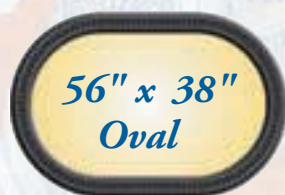

Emily's Passenger Set

an *E-Z Track*® set

Item No. 00684 • Standard Pack: 3 • \$170.00

Emily is a beautiful engine with shiny paintwork and gleaming brass fittings. After bravely rescuing two of her railway friends, Sir Topham Hatt rewarded Emily with a brand new pair of coaches. Now you can ride along with Emily as she proudly displays her splendid passenger cars to all of Sodor.

This ready-to-run train set includes:

- Emily locomotive with moving eyes
- Emily's Coach with international-style hook and loop couplers
- Emily's Brake Coach with international-style hook and loop couplers
- 47" x 38" oval of snap-fit *E-Z Track*® with 12 pieces of curved track, 1 piece of straight track, and 1 straight plug-in terminal rerailer
- power pack and speed controller
- illustrated instruction manual



Emily's Eyes
Move Side To Side



Speed Controller
with Plug-In Wiring



Thomas with Annie & Clarabel

an *E-Z Track*® set

Item No. 00642 • Standard Pack: 3 • \$120.00

Thomas and his loyal coaches Annie and Clarabel are carrying a number of very important passengers, and you're invited to join in their adventures! This HO scale electric train set is the perfect way to begin your *Thomas & Friends*™ collection.

This ready-to-run train set includes:

- Thomas the Tank Engine™ with moving eyes
- Annie coach with international-style hook and loop couplers
- Clarabel coach with international-style hook and loop couplers
- 36" circle of snap-fit *E-Z Track*® with 11 pieces of curved track and 1 curved plug-in terminal rerailer
- power pack and speed controller
- illustrated instruction manual



Salty's Dockside Delivery

an E-Z Track® set

Item No. 00696 • Standard Pack: 3 • \$175.00

NEW



Speed Controller with Plug-In Wiring



Salty, the Dockside Diesel, is busy moving goods at Brendam Docks. Join Salty as he transports cargo to and fro down by the seaside!



This ready-to-run train set includes:

- Salty with moving eyes
- 6 Ton Wagon with international-style hook and loop couplers
- Raspberry Syrup Tanker with international-style hook and loop couplers
- Salt Wagon with international-style hook and loop couplers
- Custom Conductor figure
- 47" x 38" oval of snap-fit E-Z Track® with 12 pieces of curved track, 1 piece of straight track, and 1 straight plug-in terminal rerailer
- power pack and speed controller
- illustrated instruction manual



Salty's Eyes Move Side to Side



CUSTOM CONDUCTOR



Speed Controller with Plug-In Wiring



Thomas' Eyes Move Side to Side

Thomas' Fun with Freight Set

an E-Z Track® set

Item No. 00683 • Standard Pack: 3 • \$190.00

Thomas always has an important job to do and his railway friends are there to help. You can join Thomas, S.C. Ruffey, and the Conductor as they pick up and deliver their cargo.



This ready-to-run train set includes:

- Thomas the Tank Engine™ with moving eyes
- S.C. Ruffey with international-style hook and loop couplers
- Open Wagon with international-style hook and loop couplers
- Cream Tanker with international-style hook and loop couplers
- Cattle Wagon with international-style hook and loop couplers
- Conductor figure
- 56" x 38" oval of snap-fit E-Z Track® with 12 pieces of curved track, 3 pieces of straight track, and 1 straight plug-in terminal rerailer
- power pack and speed controller
- illustrated instruction manual



CONDUCTOR



Thomas' Eyes
Move Side to Side



56" x 38"
Oval



Speed Controller
with Plug-In Wiring

Thomas' Holiday Special

an E-Z Track® set

Item No. 00682 • Standard Pack: 3 • \$160.00

Thomas is hauling the Sodor holiday tree and won't let a little snow stand in his way. Wearing a familiar hat and armed with his trusty plow, this Really Useful Engine and his festive freight cars deliver winter fun to one and all.

This ready-to-run train set includes:

- Thomas the Tank Engine™ with plow, holiday hat, and moving eyes
- Open Wagon with tree and international-style hook and loop couplers
- candy cane Tank Car with international-style hook and loop couplers
- decorated Coach with international-style hook and loop couplers
- 56" x 38" oval of snap-fit E-Z Track® with 12 pieces of curved track, 3 pieces of straight track, and 1 straight plug-in terminal rerailer
- power pack and speed controller
- illustrated instruction manual



Thomas' Eyes
Move Side to Side



Speed Controller
with Plug-In Wiring



You can build your Thomas & Friends™ collection one friend at a time with these separate-sale accessories.

HO SCALE THOMAS & FRIENDS™ SEPARATE-SALE

Standard Pack: 6



THOMAS the TANK ENGINE™
(with moving eyes)
Item No. 58741 • \$50.00
Performs best on 15" radius curves or greater.



PERCY the SMALL ENGINE
(with moving eyes)
Item No. 58742 • \$50.00
Performs best on 15" radius curves or greater.



JAMES the RED ENGINE
(with moving eyes)
Item No. 58743 • \$62.00
Performs best on 18" radius curves or greater.



GORDON the EXPRESS ENGINE
(with moving eyes)
Item No. 58744 • \$86.00
Performs best on 18" radius curves or greater.



HENRY the GREEN ENGINE
(with moving eyes)
Item No. 58745 • \$86.00
Performs best on 18" radius curves or greater.



EDWARD
(with moving eyes)
Item No. 58746 • \$86.00
Performs best on 18" radius curves or greater.



TOBY the TRAM ENGINE
(with moving eyes)
Item No. 58747 • \$55.00
Performs best on 15" radius curves or greater.



EMILY
(with moving eyes)
Item No. 58748 • \$78.00
Performs best on 18" radius curves or greater.



SPENCER
(with moving eyes)
Item No. 58749 • \$98.00
Performs best on 18" radius curves or greater.

HO SCALE THOMAS & FRIENDS™ SEPARATE-SALE (continued)

Standard Pack: 6



MAVIS
(with moving eyes)
Item No. 58801 • \$55.00
Performs best on 15" radius curves or greater.



DIESEL
(with moving eyes; not shown)
Item No. 58802 • \$77.00
Performs best on 15" radius curves or greater.



SALTY
(with moving eyes)
Item No. 58804 • \$64.00
Performs best on 15" radius curves or greater.



BILL
(with moving eyes)
Item No. 58805 • \$64.00
Performs best on 15" radius curves or greater.



BEN
(with moving eyes)
Item No. 58806 • \$64.00
Performs best on 15" radius curves or greater.



DONALD
(with moving eyes)
Item No. 58807 • \$77.00
Performs best on 18" radius curves or greater.



DOUGLAS
(with moving eyes)
Item No. 58808 • \$77.00
Performs best on 18" radius curves or greater.



MAIL CAR
Item No. 76040 • \$21.00



SPENCER'S SPECIAL COACH
Item No. 76041 • \$43.00



EMILY'S COACH
Item No. 76042 • \$17.50

HO SCALE THOMAS & FRIENDS™ SEPARATE-SALE (continued)

Standard Pack: 6



EMILY'S BRAKE COACH
Item No. 76043 • \$17.50



ANNIE COACH
Item No. 76044 • \$17.50



CLARABEL COACH
Item No. 76045 • \$17.50



GORDON'S EXPRESS BRAKE COACH
Item No. 76048 • \$43.00



GORDON'S COMPOSITE COACH
Item No. 76049 • \$43.00



VENTILATED VAN
Item No. 77026 • \$21.00



FLAT CAR with PAINT DRUMS
Item No. 77027 • \$24.50



HENRIETTA
Item No. 77028 • \$21.00



COAL WAGON with LOAD
Item No. 77029 • \$23.50



CATTLE WAGON
Item No. 77030 • \$23.50



WELL WAGON
Item No. 77031 • \$23.50



CREAM TANKER
Item No. 77032 • \$23.50



RASPBERRY SYRUP TANKER
Item No. 77033 • \$23.50

HO SCALE THOMAS & FRIENDS™ SEPARATE-SALE (continued)

Standard Pack: 6



SALT WAGON
Item No. 77034 • \$23.50



OPEN WAGON - RED
Item No. 77037 • \$21.00



OIL TANK
Item No. 77038 • \$22.00



SODOR FUEL TANK
Item No. 77039 • \$22.00



S. C. RUFFEY
Item No. 77041 • \$21.00



OPEN WAGON - BLUE
Item No. 77042 • \$21.00



CARGO CAR
Item No. 77043 • \$21.00



BRAKE VAN
Item No. 77045 • \$21.00



TROUBLESOME TRUCK #1
Item No. 77046 • \$16.50



TROUBLESOME TRUCK #2
Item No. 77047 • \$16.50



TROUBLESOME TRUCK #3
Item No. 77025 • \$16.50



TIDMOUTH MILK TANK
Item No. 77048 • \$22.00



TAR TANK
Item No. 77049 • \$22.00

HO SCALE THOMAS & FRIENDS™ SEPARATE-SALE (continued)

Standard Pack: 6



CRANKY the CRANE
(with working crane action)
Item No. 42444 • \$36.50



HAROLD the HELICOPTER
Item No. 42441 • \$17.50



BERTIE the BUS
Item No. 42442 • \$17.50



SIR TOPHAM HATT
Item No. 42443 • \$9.50



CONDUCTOR
Item No. 42445 • \$11.00



TERENCE the TRACTOR
Item No. 42447 • \$23.00



FARMER McCOLL
Item No. 42448 • \$11.00

THOMAS & FRIENDS™ SODOR SCENERY

Standard Pack: 6



SWITCH TOWER
Item No. 45237 • \$33.00



LIGHTHOUSE
with **BLINKING LED LIGHT**
(connects to AC power pack terminals)
Item No. 45240 • \$66.00

NEW
OPERATING WINDMILL
(not shown; connects to AC power pack terminals)
Item No. 45241 • \$85.00

HOOK-AND-LOOP COUPLERS (3 pairs per pack)

Item No. 78979 • Standard Pack: 12 • \$9.00

These couplers are compatible with many of our *Thomas & Friends™* products and many European prototype models.



Durango & Silverton

an E-Z Track® set with E-Z Mate® couplers

Item No. 00710 • Standard Pack: 3 • \$225.00

Built originally as a mining line, the scenic value of the *Durango & Silverton* was quickly recognized in passenger service. After surviving natural disasters, wars, and financial instability, a determined staff (and starring roles in several Hollywood movies) promoted the tourism that ensures the line's survival to this day. Now recognized as a National Historic Landmark and a National Historic Civil Engineering Landmark, the *Durango & Silverton* continues to provide year-round tourist service. Our *Durango & Silverton* passenger set comes complete with:

- 2-8-0 locomotive and tender with operating headlight
- open excursion car
- old-time combine
- old-time coach
- 47" x 38" oval of snap-fit E-Z Track® including 12 pieces of curved track, 1 piece of straight track, and 1 plug-in terminal rerailer
- power pack and speed controller
- illustrated instruction manual



47" x 38"
Oval



Speed Controller
with Plug-In Wiring

Civil War-Union

an E-Z Track® set with E-Z Mate® couplers

Item No. 00708 • Standard Pack: 3 • \$250.00



With the shots fired at Fort Sumter on April 12, 1861, the War Between the States officially began 150 years ago. From the start of the Civil War, the Union recognized the advantages offered by railroads and was quick to employ the “iron horses” for the first time in a military campaign. With the formation of the United States Military Railroads (USMRR), the Federals gained the authority to take possession of whatever equipment was necessary to operate strategic rail lines in support of the Union Army. Backed by the government and managed by the leading railroad men of the time, a well-equipped USMRR train was commonly powered by a 4-4-0 locomotive pulling a box car, flat car, water tank car, and gondola. A trailing combine often served as a guard car to ward off Confederate attacks. Our *Commemorative 150th Anniversary Edition Civil War - Union* set marks this turning point in our nation’s history and comes complete with:

- 4-4-0 American locomotive with operating headlight and tender
- old-time water car
- old-time box car
- old-time gondola
- old-time flat car
- old-time combine
- 100-piece set of Civil War military figures (blue)

- 56" x 38" oval of E-Z Track® including 12 pieces of curved track, 3 pieces of straight track, and 1 plug-in terminal rerailer
- 3 cannons
- 4 horses
- power pack and speed controller
- illustrated instruction manual



Civil War-Confederate

an E-Z Track® set with E-Z Mate® couplers

Item No. 00709 • Standard Pack: 3 • \$250.00



With the shots fired at Fort Sumter on April 12, 1861, the War Between the States officially began 150 years ago. Railroadng would play a key role in the Civil War, providing logistical support and carrying munitions, supplies, and troops to each side’s respective armies in the field. Lacking the financial power and the more standardized rail system of their Northern counterparts, Southern-held railroads relied heavily on the ingenuity of their railroad men to support the troops. A typical Confederate consist featured an assortment of commandeered rolling stock bearing the names of a variety of Southern railroads, which is reflected in this model. Our *Commemorative 150th Anniversary Edition Civil War - Confederate* set marks this turning point in our nation’s history and comes complete with:

- 4-4-0 American locomotive with operating headlight and tender
- old-time water car (Manassas Gap)
- old-time box car (Savannah, Albany & Gulf)
- old-time gondola (Fredericksburg & Potomac)

- old-time flat car (Mississippi Central & Louisiana)
- old-time bobber caboose (Atlanta & West Point)
- 100-piece set of Civil War military figures (gray)
- 3 cannons

- 4 horses
- 56" x 38" oval of E-Z Track® including 12 pieces of curved track, 3 pieces of straight track, and 1 plug-in terminal rerailer
- power pack and speed controller
- illustrated instruction manual



56" x 38"
Oval



Speed Controller
with Plug-In Wiring



This **130** piece set includes 100 Civil War military figures, 3 cannons, and 4 horses!



56" x 38"
Oval



Speed Controller
with Plug-In Wiring



This **130** piece set includes 100 Civil War military figures, 3 cannons, and 4 horses!

Santa Special **NEW**

an E-Z Track® set with E-Z Mate® couplers

Item No. 00707 • Standard Pack: 3 • \$175.00

The *Santa Special* speeds from the North Pole to make a special delivery of colorfully wrapped presents to all good boys and girls. With a tanker full of Kris Kringle's hot chocolate and a stock car to transport his famous reindeer, this ready-to-run train set has everything needed to make sure Santa is ready for a very merry Christmas. The *Santa Special* comes complete with Bachmann's exclusive E-Z Track® snap-fit track and roadbed system, plus:

- USRA 0-6-0 steam locomotive and tender with operating headlight
- gondola with presents
- reindeer transport stock car
- hot chocolate tank car
- North Pole & Southern bobber cabooses
- body-mounted E-Z Mate® couplers
- 47" x 38" oval of snap-fit E-Z Track® with 12 pieces curved track, 1 piece straight track, and 1 plug-in terminal rerailer
- power pack and speed controller
- illustrated instruction manual



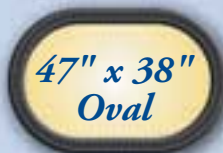

Speed Controller
with Plug-In Wiring

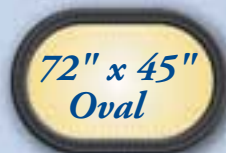

Speed Controller
with Plug-In Wiring

Overland Limited

an E-Z Track® set with E-Z Mate® couplers

Item No. 00614 • Standard Pack: 3 • \$295.00

The biggest and the best for serious railroad enthusiasts. From a powerful 4-8-4 steam locomotive, to an impressive consist of nine cars, this set has it all! The *Overland Limited* comes complete with Bachmann's exclusive *E-Z Track®* snap-fit track and roadbed system, plus:

- Union Pacific® 4-8-4 steam locomotive and tender with operating smoke and headlight
- grain car
- three-dome tank car
- flat car with logs
- center-flow hopper
- open quad offset hopper
- two plug-door box cars
- wood stock car
- wide-vision caboose
- body-mounted *E-Z Mate®* couplers
- 72" x 45" oval of snap-fit *E-Z Track®* with 16 pieces of 22" radius curved track, 5 pieces of straight track, and 1 plug-in terminal reailer
- power pack and speed controller
- illustrated instruction manual

McKinley Explorer

an E-Z Track® set with E-Z Mate® couplers

Item No. 00694 • Standard Pack: 3 • \$195.00

Treating passengers to breathtaking views of the Alaskan wilderness in special vista-dome cars is the *McKinley Explorer*. This updated version of the *McKinley Explorer* features models of the completely new bi-level dome dining-lounge cars that have recently come into service on the *Explorer*. At 18 feet 2 inches tall and 89 feet long, these cars manufactured by the Colorado Railcar Company are the largest dome cars ever built.

This ready-to-run train set includes:

- EMD GP40 diesel locomotive with operating headlight
- three all-new 89' Colorado Railcar full-dome passenger cars (the *Knik*, *Kenai*, and *Kobuk*, all named after Alaskan rivers)
- body-mounted E-Z Mate® couplers
- 63" x 45" oval of snap-fit E-Z Track® including 16 pieces of 22" radius curved track, 3 pieces of straight track, and 1 plug-in terminal railer
- power pack and speed controller
- illustrated instruction manual



Royal Gorge

an E-Z Track® set with E-Z Mate® couplers

Item No. 00689 • Standard Pack: 3 • \$195.00

Colorado's oldest scenic line combines rich history, spectacular views, and stylish accommodations into a train that takes you on a 24-mile journey through the 1,000 foot deep Royal Gorge. Passengers travel alongside the Arkansas River on a ribbon of rail for an up-close nature show deep in the canyon, observing bald eagles, blue heron, bighorn sheep, mule deer, and flora native to the gorge.

This ready-to-run train set includes:

- powered F7-A locomotive with operating headlight
- powered F7-B locomotive
- smooth-side coach
- full-dome passenger car
- body-mounted E-Z Mate® couplers
- 63" x 45" oval of snap-fit E-Z Track® including 16 pieces of 22" radius curved track, 3 pieces of straight track, and 1 plug-in terminal railer
- power pack and speed controller
- illustrated instruction manual



ELECTRIC TRAIN SETS

HO
SCALE



63" x 45"
Oval



Speed Controller with Plug-In Wiring



63" x 45"
Oval



Speed Controller with Plug-In Wiring



Empire Builder

an E-Z Track® set with E-Z Mate® couplers

Item No. 00667 • Standard Pack: 3 • \$195.00

The Great Northern Railroad's flagship passenger train was named the *Empire Builder* in honor of the railroad's founder, James J. Hill. Hill became known as the Empire Builder after reorganizing several failing railroads into the Great Northern Railway and extending the line to the Pacific Northwest in the late 19th Century. After World War II, the Empire Builder was equipped with a full length "Great Dome" passenger car to optimize the views of the passing Cascade Mountains and the Rocky Mountain landscapes of Montana's Glacier National Park.

This ready-to-run train set includes:

- powered F7-A locomotive with operating headlight
- powered F7-B locomotive
- smooth-side coach
- full-dome passenger car
- body-mounted *E-Z Mate®* couplers
- 63" x 45" oval of snap-fit *E-Z Track®* including 16 pieces of 22" radius curved track, 3 pieces of straight track, and 1 plug-in terminal rerailer
- power pack and speed controller
- illustrated instruction manual



Thoroughbred

an E-Z Track® set with E-Z Mate® couplers

Item No. 00691 • Standard Pack: 3 • \$105.00

Wheels rumble like the pounding of hooves as this iron horse rounds the bend. Hauling freight with the ease and grace of a champion, the *Thoroughbred* delivers fun and adventure to your stable of trains.

This ready-to-run train set includes:

- F7 diesel locomotive with operating headlight
- open quad hopper
- gondola
- wide-vision caboose
- body-mounted *E-Z Mate®* couplers
- 47" x 38" oval of snap-fit *E-Z Track®* including 12 pieces of curved track, 1 piece of straight track, and 1 plug-in terminal rerailer
- power pack and speed controller
- illustrated instruction manual



63" x 45"
Oval



Speed Controller
with Plug-In Wiring



47" x 38"
Oval



Speed Controller
with Plug-In Wiring





E-Z TRACK SYSTEM



Speed Controller
with Plug-In Wiring



The FT diesel locomotive in this set has a die-cast chassis and eight wheel drive.

Santa Fe Flyer

an E-Z Track® set with E-Z Mate® couplers

Item No. 00647 • Standard Pack: 3 • \$105.00

Hauling freight across the deserts, mountains, and cities of the American landscape is the *Santa Fe Flyer*. Powered by a mighty Santa Fe FT diesel locomotive with its distinctive “war bonnet” paint scheme, this sleek and powerful train deftly handles the ever-changing terrain of the Southwest United States.

This ready-to-run train set includes:

- EMD FT diesel locomotive with operating headlight
- open quad hopper
- gondola
- off-center caboose
- body-mounted *E-Z Mate*® couplers
- 36" circle of snap-fit *E-Z Track*® including 11 pieces of curved track and 1 curved plug-in terminal rerailer
- power pack and speed controller
- illustrated instruction manual



ELECTRIC TRAIN SETS

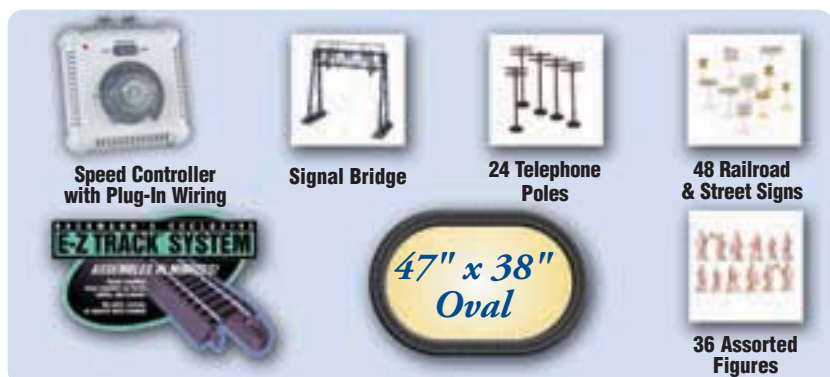

Rail Chief **NEW**

an E-Z Track® set with E-Z Mate® couplers

Item No. 00706 • Standard Pack: 3 • \$150.00

You will command the rails with our striking *Rail Chief* set. Complete with miniature people and a signal bridge, this 130-piece set will let you oversee your own detailed railroading empire.

This ready-to-run train set includes:

- EMD GP40 diesel locomotive with operating headlight
- open quad hopper
- gondola
- plug-door box car
- off-center caboose
- body-mounted *E-Z Mate*® couplers
- 47" x 38" oval of snap-fit *E-Z Track*®, including 12 pieces curved track, 1 piece of straight track, and 1 plug-in terminal rerailer
- signal bridge
- 36 miniature figures
- 24 telephone poles
- 48 railroad and street signs
- power pack and speed controller
- illustrated instruction manual

**130
Piece Set**

Pacific Flyer

an E-Z Track® set with E-Z Mate® couplers

Item No. 00692 • Standard Pack: 3 • \$110.00

Assembly and breakdown of trains in the railway yard is tough work, but this 0-6-0 steam switcher is ready to get the job done. Assemble your consist, clear the yard and move your freight to its final destination with the *Pacific Flyer!*

This ready-to-run train set includes:

- 0-6-0 steam locomotive and tender with operating headlight
- gondola
- box car
- off-center caboose
- body-mounted *E-Z Mate®* couplers
- 36" circle of snap-fit *E-Z Track®* including 11 pieces of curved track and 1 curved plug-in terminal railer
- power pack and speed controller
- illustrated instruction manual



Golden Spike®

an E-Z Track® set with E-Z Mate® couplers

Item No. 00615 • Standard Pack: 3 • \$195.00

East meets West! The world's first transcontinental railroad was completed with the driving of the final Golden Spike. Commemorating this historic event in HO scale is the 163-piece *Golden Spike®* train set, featuring Bachmann's exclusive *E-Z Track®* snap-fit track and roadbed system.

This ready-to-run train set includes:

- EMD GP40 diesel locomotive with operating headlight
- open quad hopper
- plug-door box car
- single-dome tank car
- stock car
- off-center caboose
- 63" x 38" oval of snap-fit *E-Z Track®* including 12 pieces of curved track, 6 pieces of straight track, 1 plug-in terminal railer, 1 manual turnout-left, under-track magnet with brakeman figure, and 1 Hayes bumper
- suburban station
- signal bridge
- 48 figures
- 36 telephone poles
- 48 railroad and street signs
- power pack and speed controller
- illustrated instruction manual





36" Circle

E-Z TRACK SYSTEM
ASSEMBLY & WIRING

Speed Controller with Plug-In Wiring



163
Piece Set

Speed Controller with Plug-In Wiring

Signal Bridge

36 Telephone Poles

48 Railroad & Street Signs

48 Assorted Figures

E-Z TRACK SYSTEM
ASSEMBLY & WIRING

63" x 38" Oval with Turnout and Siding

Suburban Station



36"
Circle



Speed Controller
with Plug-In Wiring



Thunderbolt

an E-Z Track® set with E-Z Mate® couplers

Item No. 00612 • Standard Pack: 3 • \$115.00

A distant roar and the trembling earth can mean only one thing: the *Thunderbolt* is on its way! With a flash of silver and red, a mighty locomotive bolts past, transporting freight to far-off destinations.

This ready-to-run train set includes:

- EMD GP40 diesel locomotive with operating headlight
- single-dome tank car
- plug-door box car
- off-center cabooses
- body-mounted E-Z Mate® couplers
- 36" circle of snap-fit E-Z Track®, including 11 pieces of curved track and 1 curved plug-in terminal rerailer
- power pack and speed controller
- illustrated instruction manual



ELECTRIC TRAIN SETS

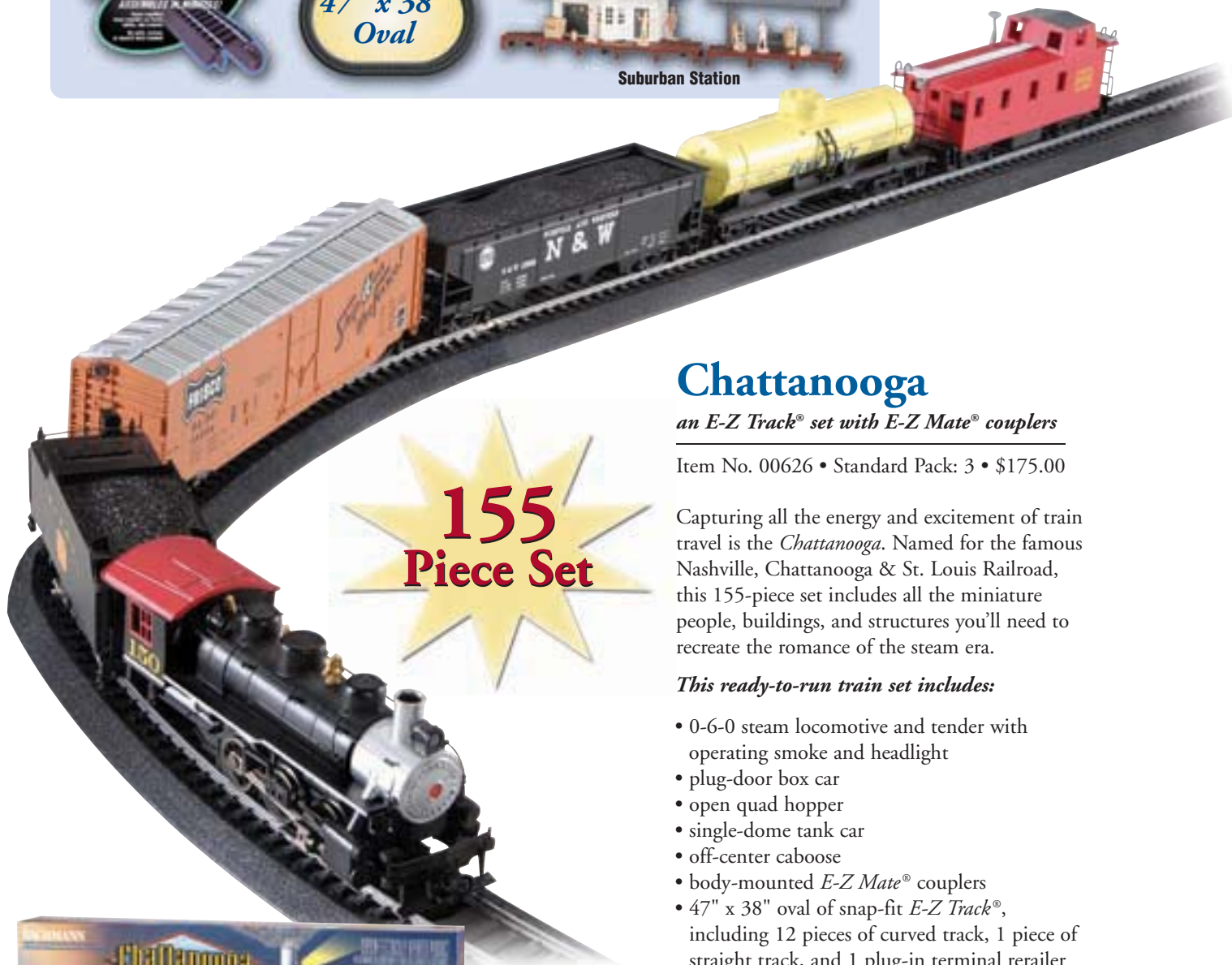

Chattanooga

an E-Z Track® set with E-Z Mate® couplers

Item No. 00626 • Standard Pack: 3 • \$175.00

Capturing all the energy and excitement of train travel is the *Chattanooga*. Named for the famous Nashville, Chattanooga & St. Louis Railroad, this 155-piece set includes all the miniature people, buildings, and structures you'll need to recreate the romance of the steam era.

This ready-to-run train set includes:

- 0-6-0 steam locomotive and tender with operating smoke and headlight
- plug-door box car
- open quad hopper
- single-dome tank car
- off-center caboose
- body-mounted E-Z Mate® couplers
- 47" x 38" oval of snap-fit E-Z Track®, including 12 pieces of curved track, 1 piece of straight track, and 1 plug-in terminal rerailer
- suburban station
- signal bridge
- 48 railroad and street signs
- 36 telephone poles
- 48 assorted figures
- power pack and speed controller
- illustrated instruction manual



Pegasus

an E-Z Track® set

Item No. 00690 • Standard Pack: 3 • \$143.00

By the late 1830s, America's pioneer railroads were coming of age with the first steps toward modern railroading. A powerful new breed of locomotive, built for improved service on the Baltimore & Ohio Railroad's expanding system was the 4-2-0 "Pegasus." Fast, agile and elegant, *Pegasus* truly earned its name, for Charles Dickens said of a sister engine that if it had spread its wings and flew away, no one would be the least bit surprised!



The Pegasus includes:

- Norris 4-2-0 locomotive ("Pegasus") with hand-tooled coal load in tender
- three historical passenger cars
- metal detail parts
- 47" x 38" oval of nickel silver E-Z Track®, including 12 pieces curved track, 1 piece of straight track, and 1 plug-in terminal rerailer
- power pack and speed controller
- illustrated instruction manual

The DeWitt Clinton

an E-Z Track® set

Item No. 00641 • Standard Pack: 3 • \$125.00

Named after the father of the Erie Canal, the DeWitt Clinton made its maiden run on August 9, 1831. As one of the earliest steam operated carriers in America, the DeWitt Clinton is truly unique in railroading history. With its passengers riding in standard stagecoach bodies mounted on railroad wheels, the sight of the DeWitt Clinton was just as startling in 1831 as it would be today!



The DeWitt Clinton includes:

- DeWitt Clinton locomotive and tender (with die-cast wood load and water barrels)
- three DeWitt Clinton coaches
- skew-wound motor
- nickel silver wheels
- 47" x 38" oval of nickel silver E-Z Track®, including 12 pieces curved track, 1 piece of straight track, and 1 plug-in terminal rerailer
- power pack and speed controller
- illustrated instruction manual

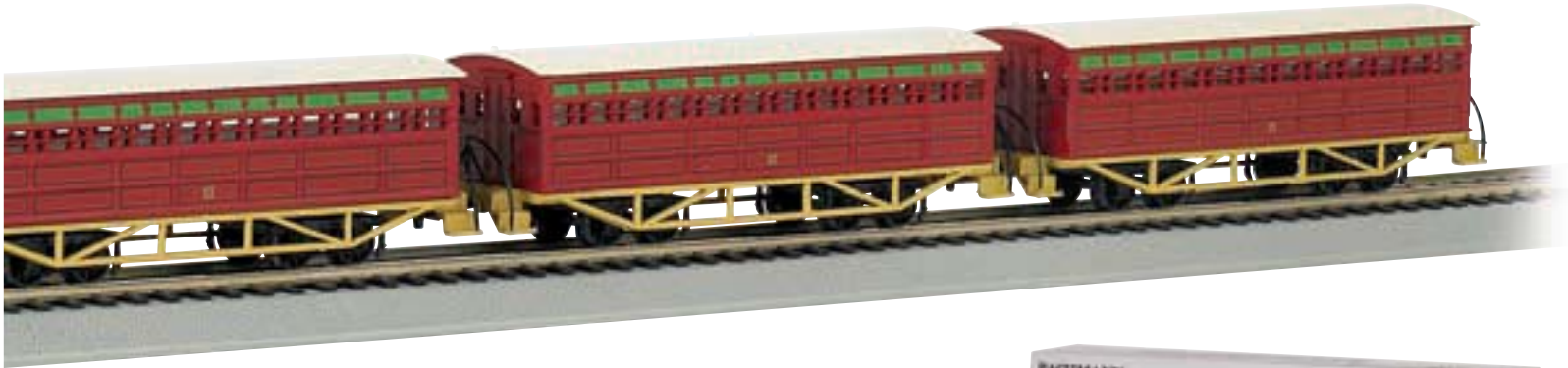

47" x 38"
Oval



Speed Controller
with Plug-In Wiring



47" x 38"
Oval



Speed Controller
with Plug-In Wiring

Digital Commander

an *E-Z Track*® set with *E-Z Mate*® couplers

Item No. 00501 • Standard Pack: 3 • \$325.00

DCC ON BOARD™

Model railroading enters the digital age with the *Digital Commander!* Create your own fledgling railroad empire or work with a friend to coordinate freight and switching operations. Our exclusive *E-Z Command*® digital control system lets you independently control the speed, direction, and lighting of two decoder-equipped locomotives.

This digitally controlled train set features:

- DCC-equipped EMD GP40 locomotive with operating headlight
- DCC-equipped EMD FT-A locomotive with operating headlight
- plug-door box car
- open quad hopper
- wide-vision caboose
- *E-Z Command*® Control Center with wall pack and plug-in wiring
- body-mounted *E-Z Mate*® couplers
- 56" x 38" oval of nickel silver *E-Z Track*®, including 12 pieces curved track, 4 pieces straight track, 1 terminal rerailer, 1 manual turnout – left, under-track magnet with brakeman figure, and 1 Hayes bumper
- DVD-format *E-Z Command*® instruction video
- illustrated instruction manual

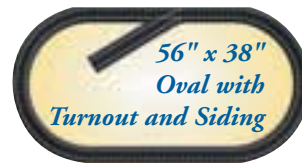

Digital Speed Controller with Plug-In Wiring



DCC ON BOARD™

Diesel Digital Commander

an E-Z Track® set with E-Z Mate® couplers

Item No. 00503 • Standard Pack: 3 • \$319.00

Conduct digital operations on a modern-era railroad with the *Diesel Digital Commander*. Our exclusive *E-Z Command®* digital control system lets you control the speed, direction, and lighting of the decoder-equipped locomotive while you practice switching operations on the included siding.

DCCTM
ON BOARD



This digitally controlled train set features:

- DCC-equipped EMD GP40 diesel locomotive with operating headlight
- three-dome tank car
- gondola
- wide-vision caboose
- body-mounted *E-Z Mate®* couplers
- 56" x 38" oval of nickel silver *E-Z Track®*, including 12 pieces of curved track, 4 pieces of straight track, and 1 plug-in terminal railer, 1 manual turnout – left, under-track magnet with brakeman figure, and 1 Hayes bumper
- DVD format *E-Z Command®* instruction video
- illustrated instruction manual

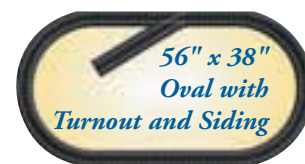

Digital Speed Controller with Plug-In Wiring

E-Z Command® **Dynamis® Wireless Digital Command Control System**



E-Z COMMAND® DYNAMIS® WIRELESS INFRARED DCC SYSTEM

Item No. 36505 • Standard Pack: 4 • \$350.00

E-Z Command® Dynamis® allows the operator total freedom by integrating two-way wireless technology into an advanced digital command control system. Using a unique toggle style joystick, both the speed and the selection of locomotives are controlled. A backlit LCD screen with graphical interface and easy-to-use menu buttons make operation and programming of up to 9,999 addresses and CVs simple and intuitive. The ten function buttons allow for one-touch operation of sound and lighting features. Turnout and accessory decoders can also be fully controlled by the *Dynamis®* system, giving you digital mastery of your railroad.



*Dynamis® Wireless Infrared Handset
with Backlit LCD Screen*



*Dynamis® Command Station, including
Wireless Infrared Signal Receiver*

Features include:

- two-way wireless infrared operation
- constant digital information updates of handset commands to locomotive, and of locomotive performance back to handset
- joystick control for locomotive selection and speed
- programming on the main
- 9,999 locomotive addresses
- supports 14, 28 or 128 speed steps
- full CV programming
- easy-to-use backlit LCD screen
- control of up to 40 locomotives at any one time (up to 21 functions per locomotive)
- allows 40 consists of up to five locomotives each
- universally compatible track connection
- expandable modular design
- four AAA batteries included
- suitable for all layouts, from train sets to sophisticated railroads
- 2.3 amp power supply
- conforms to all applicable NMRA standards



DYNAMIS® DCC SYSTEM

E-Z COMMAND® DYNAMIS® WIRELESS INFRARED DCC SYSTEM (continued)

E-Z COMMAND® DYNAMIS® HANDSET

Item No. 36507 • Standard Pack: 4 • \$170.00

The use of additional handsets provides multiple-person operation of your railroad. Use the *E-Z Command® Dynamis®* handset with the *Dynamis®* Pro Box (Item No. 36508) to increase the number of operators on your layout. Four handsets can be used simultaneously with the *Dynamis®* Pro system.



E-Z COMMAND® DYNAMIS® PRO BOX

Item No. 36508 • Standard Pack: 4 • \$500.00

Adding the *E-Z Command®* Pro Box to your *Dynamis®* DCC system delivers more versatility to your railroad. The *Dynamis®* Pro Box allows the use of three additional wireless controllers (limit 4), additional wireless receivers and the use of programming tracks to read and write CV values. All of this will transform your *Dynamis®* system into a *Dynamis®* "Pro" system.



E-Z COMMAND® DYNAMIS® WIRELESS RECEIVER

Item No. 36509 • Standard Pack: 4 • \$50.00

Additional infrared receiver for use with Bachmann *E-Z Command® Dynamis®* Pro Box. Provides extended receiver coverage.



E-Z Command® Digital Command Control System

Standard Pack: 3 • \$145.00

AC Wall Pack Power
Supply

Enjoy the fastest way to get going in DCC with our E-Z Command® Digital Command Control System. In partnership with Lenz Elektronik GmbH, Bachmann brings you a DCC system that is both easy to use and affordable for novice and experienced hobbyists alike. E-Z Command® allows modelers to digitally control speed, direction, lighting, and sound of multiple locomotives. E-Z Command® also streamlines the programming process with simple, main-track programming.

Features include:

- digital control of multiple locomotives in all scales (E-Z Command® 5 Amp Power Booster, Item No. 44910, required for O scale and Large Scale operation)
- plug-and-play compatibility with all DC and DCC systems
- digitally control speed, direction, lighting, and sound
- simple, on-track programming
- 28 speed step control
- 1 amp AC wall pack power supply
- plug-in wiring
- DVD and printed instructions

E-Z COMMAND® CONTROL CENTER
Item No. 44902



DCC ON BOARD

E-Z COMMAND® 1 AMP LOCOMOTIVE DECODERS

Standard Pack: 6



Introduce your locomotives to the digital age with our basic 1 amp decoders, offered in two wiring configurations.

- dual-mode decoder (automatic analog or DCC operation)
- compatible with NMRA-compliant DCC systems
- control speed, direction, and lighting functions (including headlight dimming)
- service mode decoder lock for changing the address on the layout
- ops mode programming
- two- or four-digit addresses
- 14, 27, 28, 128 speed steps
- basic and advanced consisting
- acceleration, deceleration, and start voltage adjustment
- instructions included



16 x 25 x 5mm E-Z COMMAND® DCC DECODER with WIRE HARNESS
Item No. 44913 (1 per card) • \$34.50
Item No. 44914 (3 per card) • \$100.00



16 x 25 x 5mm E-Z COMMAND® DCC DECODER with NMRA 8-PIN PLUG
Item No. 44915 (1 per card) • \$39.00
Item No. 44916 (3 per card) • \$109.00

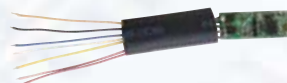

9.5 x 25 x 5mm E-Z COMMAND® DCC DECODER with WIRE HARNESS
(1 per card)
Item No. 44925 • \$40.00



9.5 x 25 x 5mm E-Z COMMAND® DCC DECODER with NMRA 8-PIN PLUG
(1 per card)
Item No. 44926 • \$44.00

**DECODER-EQUIPPED NICKEL SILVER
E-Z TRACK® TURNOUTS**

Standard Pack: 4 (unless otherwise noted)



Includes addressable DCC decoder compatible with all NMRA-compliant DCC controllers.



**E-Z COMMAND® DCC
#4 TURNOUT - LEFT**
Item No. 44139 • \$55.00



**E-Z COMMAND® DCC
#4 TURNOUT - RIGHT**
Item No. 44140 • \$55.00



**E-Z COMMAND® DCC
TURNOUT - LEFT**
Item No. 44130 • \$46.00



**E-Z COMMAND® DCC
TURNOUT - RIGHT**
Item No. 44131 • \$46.00



**E-Z COMMAND® DCC
#5 TURNOUT - LEFT**
Item No. 44132 • \$56.00



**E-Z COMMAND® DCC
#5 TURNOUT - RIGHT**
Item No. 44133 • \$56.00



**E-Z COMMAND® DCC
#5 WYE TURNOUT**
Item No. 44134 • \$56.00



**E-Z COMMAND® DCC
#6 TURNOUT - LEFT**
Item No. 44135 • \$69.00



**E-Z COMMAND® DCC
#6 TURNOUT - RIGHT**
Item No. 44136 • \$69.00



**E-Z COMMAND® DCC
#6 SINGLE CROSSOVER
TURNOUT - LEFT**
(1 per box; Standard Pack: 2)
Item No. 44137 • \$79.00



**E-Z COMMAND® DCC
#6 SINGLE CROSSOVER
TURNOUT - RIGHT**
(1 per box; Standard Pack: 2)
Item No. 44138 • \$79.00

E-Z COMMAND® WALK-AROUND COMPANION (with Connector Wires)

Item No. 44907 • Standard Pack: 3 • \$132.00

Control multiple trains from convenient locations around your layout or coordinate independent railroad operations between a primary and secondary user.

- plug-and-play connection to *E-Z Command®* Control Center
- duplicates all locomotive addresses set on *E-Z Command®* Control Center
- simultaneous throttle control of several locomotives



Item No. 44907

E-Z COMMAND® WALK-AROUND COMPANION CONNECTOR PANEL (with Connector Wire)

Item No. 44908 • Standard Pack: 6 • \$46.00

Used in conjunction with the *E-Z Command®* Walk-Around Companion, multiple connector panels let you establish a series of control points virtually anywhere on the perimeter of your layout.

- plug-in ports
- oversee railroad operations from convenient locations around your layout



Item No. 44908

E-Z COMMAND® 5 AMP POWER BOOSTER

Item No. 44910 • Standard Pack: 3 • \$335.00

The *E-Z Command®* 5 Amp Power Booster provides extra current to the track for an increased number of DCC locomotives on your HO, N, O, or Large Scale layout. Compatible with any NMRA-compliant DCC system.



Item No. 44910

E-Z COMMAND® AUTOMATIC REVERSE LOOP MODULE

Item No. 44912 • Standard Pack: 6 • \$84.00

This *E-Z Command®* accessory eliminates the complicated wiring previously needed to operate analog reverse-loop track layouts.

- module senses train as it moves along the loop, automatically switching polarity to allow reverse loop travel



Item No. 44912



E-Z Command® DCC System with DCC-Equipped Diesel Locomotive

Locomotives perform best on 18" radius curves or greater.

Standard Pack: 3 • \$219.00 each

Features include:

- E-Z Command® control center (see page 34 for feature listing)
- diesel locomotive DCC-equipped for speed, direction, and lighting control
- AC wall pack power supply



EMD GP40 BNSF
Item No. 44923



EMD GP40 UNION PACIFIC®
Item No. 44924



E-Z Command® DCC System with DCC-Equipped Steam Locomotive

Locomotives perform best on 18" radius curves or greater.

Standard Pack: 3 • \$219.00 each

Features include:

- E-Z Command® control center (see page 34 for feature listing)
- USRA 0-6-0 steam locomotive and Vanderbilt tender DCC-equipped for speed, direction, and lighting control
- AC wall pack power supply



USRA 0-6-0 SOUTHERN PACIFIC
Item No. 44930



USRA 0-6-0 SEABOARD®
Item No. 44931



HO SCALE

STEAM LOCOMOTIVES

BALDWIN 2-8-0 CONSOLIDATION LOCOMOTIVE (DCC EQUIPPED)

Performs best on 18" radius curves or greater.

Standard Pack: 6 • \$160.00 each

DCC ON BOARD™ locomotives feature dual-mode digital command control decoders enabling operation with a standard DC analog power pack or any NMRA-compliant Digital Command Control system. Speed, direction, and lighting control.

DCC[™]
ON BOARD



WESTERN MARYLAND® #760
(Fireball)
Item No. 51307

NEW



UNION PACIFIC® #616
Item No. 51308

NEW

NEW

SOUTHERN PACIFIC #2846
(not shown)
Item No. 51309

NEW

LEHIGH & NEW ENGLAND #304
Item No. 51310



SANTA FE #2511
Item No. 51311

NEW



NICKEL PLATE #493
Item No. 51312

NEW



DCC ON BOARD™

STEAM LOCOMOTIVES

2-10-4 SANTA FE (1940s - 1950s version) (DCC EQUIPPED)

Performs best on 22" radius curves or greater.

Standard Pack: 6 • \$231.00 each

DCC ON BOARD™ locomotives feature dual-mode digital command control decoders enabling operation with a standard DC analog power pack or any NMRA-compliant Digital Command Control system. Speed, direction, and lighting control.

DCC
ON BOARD



SANTA FE #5016
Item No. 51203



SANTA FE #5026
Item No. 51204



SANTA FE #5034
Item No. 51205



HO SCALE

STEAM LOCOMOTIVES



NIAGARA 4-8-4 & TENDER with OPERATING HEADLIGHT (DCC EQUIPPED)

Performs best on 22" radius curves or greater.

Standard Pack: 6 • \$215.00 each

DCC ON BOARD™ locomotives feature dual-mode digital command control decoders enabling operation with a standard DC analog power pack or any NMRA-compliant Digital Command Control system. Speed, direction, and lighting control.



NEW YORK CENTRAL® #6009
(not shown)
Item No. 50301

NEW YORK CENTRAL® #6014
Item No. 50302

NORTHERN 4-8-4 & TENDER with OPERATING HEADLIGHT (DCC EQUIPPED)

Performs best on 22" radius curves or greater.

Standard Pack: 6 • \$215.00 each

DCC ON BOARD™ locomotives feature dual-mode digital command control decoders enabling operation with a standard DC analog power pack or any NMRA-compliant Digital Command Control system. Speed, direction, and lighting control.



SANTA FE (1940s - 1950s) #3781
(not shown)
Item No. 50802

SANTA FE (1940s - 1950s) #3783
Item No. 50803

SANTA FE (1940s - 1950s) #3784
(not shown)
Item No. 50804



DCC ON BOARD™

STEAM LOCOMOTIVES

DCCTM
ON BOARD

GS4 4-8-4 & TENDER with OPERATING HEADLIGHT (DCC EQUIPPED)

Performs best on 22" radius curves or greater.

Standard Pack: 6 • \$215.00 each

DCC ON BOARDTM locomotives feature dual-mode digital command control decoders enabling operation with a standard DC analog power pack or any NMRA-compliant Digital Command Control system. Speed, direction, and lighting control.



SOUTHERN PACIFICTM RAILFAN DAYLIGHT #4449
(not shown)
Item No. 50201

SOUTHERN PACIFICTM DAYLIGHT #4446
Item No. 50202



SOUTHERN PACIFICTM POST-WAR #4459
Item No. 50203



1976 AMERICAN FREEDOM TRAIN #4449
Item No. 50205



Have a question? You can "Ask the Bach-Man" on our message board at www.bachmanntrains.com!



2-8-4 BERKSHIRE STEAM LOCOMOTIVE & TENDER with OPERATING HEADLIGHT (DCC EQUIPPED)

Performs best on 22" radius curves or greater.

Standard Pack: 6 • \$193.00 each

DCC ON BOARD™ locomotives feature dual-mode digital command control decoders enabling operation with a standard DC analog power pack or any NMRA-compliant Digital Command Control system. Speed, direction, and lighting control.



PERE MARQUETTE #1225
Item No. 50901



PERE MARQUETTE #1218
Item No. 50902



CHESAPEAKE & OHIO®
KANAWHA #2724
Item No. 50904



NICKEL PLATE #759 - RAIL FAN VERSION
Item No. 50905



PAINTED, UNLETTERED - NICKEL PLATE VERSION
Item No. 50949



DCC ON BOARD™

STEAM LOCOMOTIVES

PRAIRIE 2-6-2 & TENDER
with SMOKE & OPERATING HEADLIGHT
Performs best on 18" radius curves or greater.

Standard Pack: 12 • \$110.00 each



UNION PACIFIC® #1836
Item No. 51501



SOUTHERN
Item No. 51504



BALTIMORE & OHIO® #9720
Item No. 51511



RIO GRANDE™ #76
(Flying Grande)
Item No. 51517



NEW YORK CENTRAL® #1905
Item No. 51520

2-6-0 MOGUL & TENDER with SMOKE & OPERATING HEADLIGHT
Performs best on 18" radius curves or greater.

Standard Pack: 12 • \$110.00 each

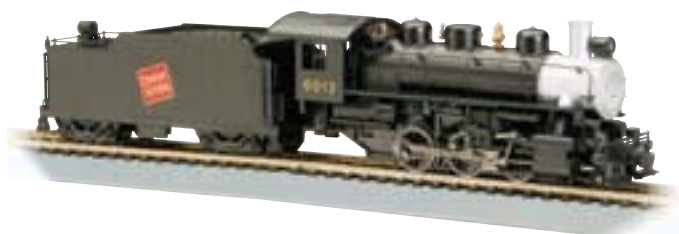

CANADIAN NATIONAL #6012
Item No. 56513



PENNSYLVANIA #3233
Item No. 56514

USRA 0-6-0 & SHORT HAUL TENDER with SMOKE (DCC EQUIPPED)

Performs best on 18" radius curves or greater.

Standard Pack: 6 • \$109.00



SMOKY MOUNTAIN #45
Item No. 52001



USRA 0-6-0 & VANDERBILT TENDER with SMOKE & OPERATING HEADLIGHT (DCC EQUIPPED)

Performs best on 18" radius curves or greater.

Standard Pack: 6 • \$109.00



UNION PACIFIC® #4443
(Greyhound)
Item No. 51901



USRA 0-6-0 & VANDERBILT TENDER with SMOKE & OPERATING HEADLIGHT

Performs best on 18" radius curves or greater.

Standard Pack: 12 • \$87.00 each



UNION PACIFIC® #4441
(Greyhound)
Item No. 50701



SOUTHERN PACIFIC™ #1277
Item No. 50707



GREAT NORTHERN
Item No. 50711

STEAM LOCOMOTIVES

USRA 0-6-0 & SHORT HAUL TENDER with SMOKE

Performs best on 18" radius curves or greater.

Standard Pack: 12 • \$87.00



SMOKY MOUNTAIN #97
Item No. 50440

AMERICAN 4-4-0 & TENDER

Performs best on 18" radius curves or greater.

Standard Pack: 12 • \$110.00 each



UNION PACIFIC® #119
Item No. 51101



PENNSYLVANIA
Item No. 51114

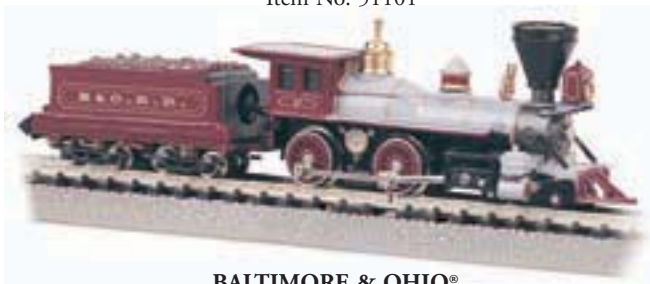

BALTIMORE & OHIO®
Item No. 51112

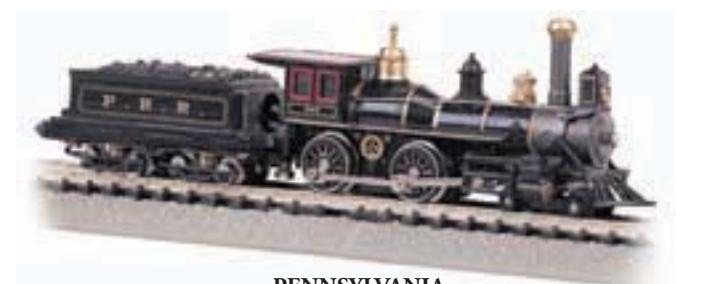

BALTIMORE & OHIO®
(1890s version - Royal Blue)
Item No. 51144

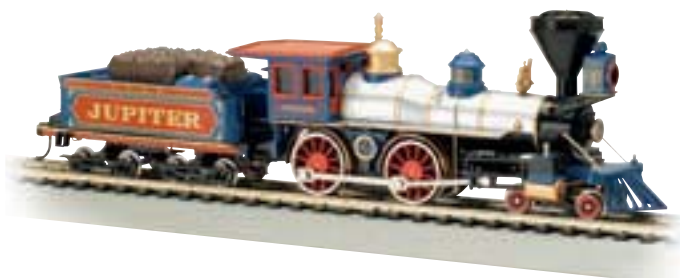

CENTRAL PACIFIC "JUPITER"
Item No. 51124

HO SCALE

STEAM LOCOMOTIVES

USRA 0-6-0 & SLOPE TENDER
with SMOKE & OPERATING HEADLIGHT
Performs best on 18" radius curves or greater.

Standard Pack: 6 • \$109.00 each

DCC ON BOARD™ locomotives feature dual-mode digital command control decoders enabling operation with a standard DC analog power pack or any NMRA-compliant Digital Command Control system. Speed, direction, and lighting control.

DCC™
ON BOARD



UNION PACIFIC® #4439
Item No. 51601

NEW



SANTA FE #2121
Item No. 51602

NEW



BALTIMORE & OHIO® #353
Item No. 51603

NEW



PENNSYLVANIA #7834
Item No. 51604

NEW



NEW YORK CENTRAL® #232
Item No. 51605

NEW

DCC ON BOARD™

STEAM LOCOMOTIVES

USRA 0-6-0 & SLOPE TENDER
with SMOKE & OPERATING HEADLIGHT
Performs best on 18" radius curves or greater.

Standard Pack: 12 • \$87.00 each



UNION PACIFIC® #4432
Item No. 50601



SANTA FE #2126
Item No. 50602



BALTIMORE & OHIO®
Item No. 50612



PENNSYLVANIA #3234
Item No. 50615



NEW YORK CENTRAL® #1430
Item No. 50620



Have a question? You can
"Ask the Bach-Man" on
our message board at
www.bachmanntrains.com!



ALCO RS-3 DIESEL LOCOMOTIVE (DCC EQUIPPED)

Performs best on 18" radius curves or greater.

Standard Pack: 6 • \$99.00

Introduced in 1950, this all-purpose 1600-HSP locomotive had the stamina and strength for freight and passenger service yet was agile enough for yard work. With its rugged, dependable design, it's no wonder that many of these versatile RS-3 locomotives are still working today on short lines, tourist lines, and hauling freight.

Features include:

- DCC-equipped for speed, direction, and lighting
- dual-mode NMRA-compliant decoder with 8-pin plug
- all-wheel drive
- precision can motor
- dual, precision-balanced flywheels
- super-quiet, helical cut gears
- die-cast chassis
- metal cut levers
- finescale handrails
- blackened metal wheels
- prototype-specific headlights
- RP25 wheel contours
- E-Z Mate® Mark II couplers



BOSTON & MAINE #1545
(not shown; maroon, yellow, & black)
Item No. 64201



DENVER & RIO GRANDE WESTERN™ #5200
(early)
Item No. 64202



SOUTHERN #2137
Item No. 64204



NEW YORK CENTRAL® #8298
(lightning stripe)
Item No. 64206

DCC ON BOARD™



WESTERN MARYLAND® #198
(speed lettering)
Item No. 64203



PENNSYLVANIA #8604
Item No. 64205

DIESEL LOCOMOTIVES

EMD GP9 (DCC EQUIPPED)

Performs best on 18" radius curves or greater.

Standard Pack: 6 • \$98.00

Built by the Electro-Motive Division of General Motors between 1954 and 1963, this entry in the "Geep" series was one of the best-selling diesels ever produced. It was distinguished by a powerful 16-cylinder 1,750-HSP 567 engine and available with optional dynamic brakes and winterization hatch. Our DCC-equipped version is produced from all new tooling.

Features include:

- DCC-equipped for speed, direction, and lighting
- dual-mode NMRA-compliant decoder with 8-pin plug
- all-wheel drive
- precision can motor
- dual, precision-balanced flywheels
- super-quiet drive train
- die-cast chassis
- metal cut levers
- finescale handrails
- blackened metal wheels
- directional lighting
- RP25 wheel contours
- E-Z Mate® Mark II couplers

DCCTM
ON BOARD



UNION PACIFIC® #173
(with dynamic brakes)
Item No. 62801



PENNSYLVANIA #7046
(with dynamic brakes)
Item No. 62802



SANTA FE #2876
(zebra stripe; with dynamic brakes)
Item No. 62803



CANADIAN NATIONAL #1701
(with dynamic brakes)
Item No. 62804



BALTIMORE & OHIO® #6431
(Capitol Dome; with dynamic brakes)
Item No. 62805



LOUISVILLE & NASHVILLE #506
Item No. 62806

DCC ON BOARD

HO SCALE

DIESEL AND ELECTRIC LOCOMOTIVES

EMD DD40AX CENTENNIAL (DCC EQUIPPED)

Performs best on 22" radius curves or greater.

Standard Pack: 6 • \$143.00 each

DCC ON BOARD™ locomotives feature dual-mode digital command control decoders enabling operation with a standard DC analog power pack or any NMRA-compliant Digital Command Control system. Speed, direction, and lighting control.

DCCTM
ON BOARD



NEW

UNION PACIFIC® #6900
(not shown)
Item No. 62105

NEW

UNION PACIFIC® #6910
Item No. 62106

NEW

UNION PACIFIC® #6919
(not shown)
Item No. 62107

NEW

UNION PACIFIC® #6942
(not shown)
Item No. 62108

E60CP (DCC EQUIPPED)

Performs best on 22" radius curves or greater.

Standard Pack: 6 • \$130.00 each

DCC ON BOARD™ locomotives feature dual-mode digital command control decoders enabling operation with a standard DC analog power pack or any NMRA-compliant Digital Command Control system. Speed, direction, and lighting control.

DCCTM
ON BOARD



NEW

AMTRAK PHASE II #976
Item No. 65506



NEW

AMTRAK PHASE III #978
Item No. 65507

DCC ON BOARD™

DIESEL LOCOMOTIVES

EMD GP50 (DCC EQUIPPED)

Performs best on 18" radius curves or greater.

Standard Pack: 6 • \$79.00

DCC ON BOARD™ locomotives feature dual-mode digital command control decoders enabling operation with a standard DC analog power pack or any NMRA-compliant Digital Command Control system. Speed, direction, and lighting control.



Have a question? You can "Ask the Bach-Man" on our message board at www.bachmanntrains.com!

DCCTM
ON BOARD



NORFOLK & WESTERN
Item No. 60442

EMD GP50 with 8-WHEEL DRIVE

Performs best on 18" radius curves or greater.

Standard Pack: 6 • \$51.00 each



SOUTHERN #9014
Item No. 61205



NORFOLK & WESTERN #6518
Item No. 61206



NORFOLK SOUTHERN #6551
Item No. 61241



HO SCALE

DIESEL LOCOMOTIVES

EMD GP40 (DCC EQUIPPED)

Performs best on 18" radius curves or greater.

Standard Pack: 6 • \$79.00 each

DCC ON BOARD™ locomotives feature dual-mode digital command control decoders enabling operation with a standard DC analog power pack or any NMRA-compliant Digital Command Control system. Speed, direction, and lighting control.

DCC ON BOARD™



SANTA FE
Item No. 60302



PENN CENTRAL #3007
Item No. 60303



CONRAIL
Item No. 60306



CHESSIE®
Item No. 60309



WESTERN MARYLAND®
Item No. 60337



ALASKA #3015
Item No. 60348

DCC ON BOARD™

DIESEL LOCOMOTIVES

HO SCALE

EMD GP40 with 8-WHEEL DRIVE

Performs best on 18" radius curves or greater.

Standard Pack: 6 • \$52.00 each



UNION PACIFIC®
Item No. 63501



SANTA FE #3504
Item No. 63504



CONRAIL #3072
Item No. 63505

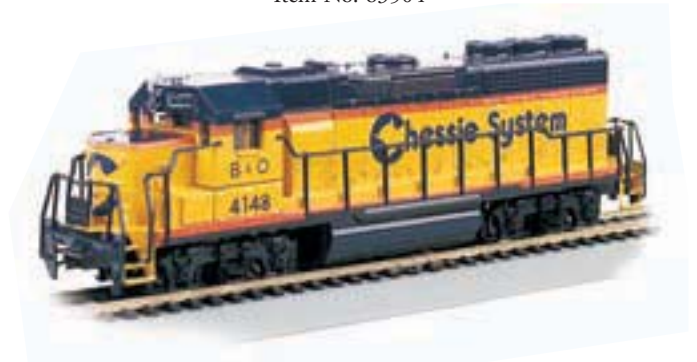

CHESSIE® #4148
Item No. 63507



WESTERN MARYLAND® #3799
Item No. 63508



ALASKA #3019
Item No. 63510



SOUTHERN PACIFIC™ #7100
Item No. 63511



CSX® #6210
(Dark Future)
Item No. 63512

HO SCALE

DIESEL LOCOMOTIVES

EMD GP38-2 (DCC EQUIPPED)

Performs best on 18" radius curves or greater.

Standard Pack: 6 • \$87.00 each



DCC ON BOARD™ locomotives feature dual-mode digital command control decoders enabling operation with a standard DC analog power pack or any NMRA-compliant Digital Command Control system. Speed, direction, and lighting control.



SANTA FE
Item No. 61101



CSX®
(Bright Future)
Item No. 61103



DELAWARE & HUDSON
Item No. 61104



UNION PACIFIC®
Item No. 61107



NORFOLK SOUTHERN #5817
(Thoroughbred)
Item No. 61108



PENN CENTRAL #8146
Item No. 61109



CSX® #2667
(Dark Future)
Item No. 61110



CANADIAN NATIONAL #4721
Item No. 61111

DCC ON BOARD™

DIESEL LOCOMOTIVES

EMD GP38-2

Performs best on 18" radius curves or greater.

Standard Pack: 6 • \$65.00 each



CANADIAN NATIONAL #4723
Item No. 61707



CSX® #2782
(Dark Future)
Item No. 61708



NORFOLK SOUTHERN #5814
(Thoroughbred)
Item No. 61709



PENN CENTRAL #8150
Item No. 61710



NEW ENGLAND CENTRAL #3848
(not shown)
Item No. 61711



WISCONSIN CENTRAL #2001
(not shown)
Item No. 61712



Have a question? You can
"Ask the Bach-Man" on
our message board at
www.bachmanntrains.com!



HO SCALE

DIESEL LOCOMOTIVES

EMD GP35 (DCC EQUIPPED)

Performs best on 18" radius curves or greater.

Standard Pack: 6 • \$79.00 each

DCC ON BOARD™ locomotives feature dual-mode digital command control decoders enabling operation with a standard DC analog power pack or any NMRA-compliant Digital Command Control system. Speed, direction, and lighting control.



CONRAIL #2269
Item No. 60702



CANADIAN PACIFIC #8205
Item No. 60705



WESTERN MARYLAND® #3579
Item No. 60708



CP RAIL #5003
Item No. 60709



UNION PACIFIC® #743
Item No. 60713



PENNSYLVANIA #2265
Item No. 60714



CSX® #4412
(Bright Future)
Item No. 60715

DCC ON BOARD™

DIESEL LOCOMOTIVES

EMD GP35

Performs best on 18" radius curves or greater.

Standard Pack: 6 • \$62.00 each



CP RAIL #5006
Item No. 11516



SANTA FE #2897
Item No. 11517



WESTERN MARYLAND® #3578
Item No. 11518



UNION PACIFIC® #747
Item No. 11519



CONRAIL #7768
Item No. 11521

NEW

ALASKA #2502
(not shown)
Item No. 11522



Have a question? You can "Ask the Bach-Man" on our message board at www.bachmanntrains.com!



EMD GP30 (DCC EQUIPPED)

Performs best on 18" radius curves or greater.

Standard Pack: 6 • \$79.00 each



DCC ON BOARD™ locomotives feature dual-mode digital command control decoders enabling operation with a standard DC analog power pack or any NMRA-compliant Digital Command Control system. Speed, direction, and lighting control.



GREAT NORTHERN #3009
Item No. 60804



BALTIMORE & OHIO® #6936
(Capitol Dome)
Item No. 60806



NICKEL PLATE #903
Item No. 60809

NICKEL PLATE #905
(not shown)
Item No. 60810



SANTA FE #3229
Item No. 60814



UNION PACIFIC® #733
Item No. 60815



PENNSYLVANIA #2212
Item No. 60816



EMD GP30

Performs best on 18" radius curves or greater.

Standard Pack: 6 • \$55.00 each



EMD #1962
(demonstrator)
Item No. 62301



UNION PACIFIC® #736
Item No. 62302



CANADIAN PACIFIC #8201
Item No. 62303



NICKEL PLATE #904
Item No. 62304



GREAT NORTHERN #3003
Item No. 62305



SANTA FE #3234
Item No. 62306

HO SCALE

DIESEL LOCOMOTIVES

EMD GP7 (DCC EQUIPPED)

Performs best on 18" radius curves or greater.

Standard Pack: 6 • \$98.00 each

DCC ON BOARD™ locomotives feature dual-mode digital command control decoders enabling operation with a standard DC analog power pack or any NMRA-compliant Digital Command Control system. Speed, direction, and lighting control.

DCC ON BOARD™

- features NMRA 8-pin plug and socket decoder installation



CHESSIE® #5606
Item No. 62403



PENNSYLVANIA #8803
Item No. 62407

NEW



UNION PACIFIC® #114
Item No. 62408

NEW



BALTIMORE & OHIO® #6411
Item No. 62409

NEW



NEW YORK CENTRAL® SYSTEM #5607
Item No. 62410

NEW

NEW

ERIE #1211
(black & yellow; not shown)
Item No. 62411

NEW

RIO GRANDE #5102
(not shown)
Item No. 62412

NEW

SOUTHERN #2183
(tuxedo scheme; not shown)
Item No. 62413



DCC ON BOARD™

DIESEL LOCOMOTIVES

BALDWIN RF-16 SHARK A UNIT (DCC EQUIPPED)

Performs best on 18" radius curves or greater.

Standard Pack: 6 • \$100.00 each



DCC ON BOARD™ locomotives feature dual-mode digital command control decoders enabling operation with a standard DC analog power pack or any NMRA-compliant Digital Command Control system. Speed, direction, and lighting control.



DELAWARE & HUDSON #1205
Item No. 61801



PENNSYLVANIA
(five stripe)
Item No. 61802



NEW YORK CENTRAL®
(lightning stripe)
Item No. 61803



BALTIMORE & OHIO®
Item No. 61804



DELAWARE & HUDSON #1216
Item No. 61806



PENNSYLVANIA
(single stripe)
Item No. 61808

BALDWIN RF-16 SHARK B UNIT (DCC EQUIPPED)

Performs best on 18" radius curves or greater.

Standard Pack: 6 • \$100.00 each



DCC ON BOARD™ locomotives feature dual-mode digital command control decoders enabling operation with a standard DC analog power pack or any NMRA-compliant Digital Command Control system. Speed, direction, and lighting control.



PENNSYLVANIA
(five stripe)
Item No. 61902



NEW YORK CENTRAL®
(lightning stripe)
Item No. 61903

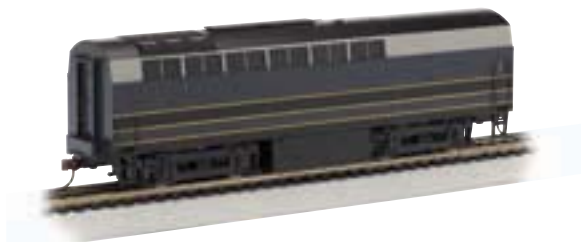

BALTIMORE & OHIO®
Item No. 61904

EMD SD40-2 (DCC EQUIPPED)

Performs best on 18" radius curves or greater.

Standard Pack: 6 • \$87.00 each



DCC ON BOARD™ locomotives feature dual-mode digital command control decoders enabling operation with a standard DC analog power pack or any NMRA-compliant Digital Command Control system. Speed, direction, and lighting control.



SANTA FE #5034
Item No. 60901



UNION PACIFIC® #4081
Item No. 60904



CP RAIL #5931
(Multi-mark)
Item No. 60906



CSX® #8868
(Dark Future)
Item No. 60908



CANADIAN NATIONAL #6126
Item No. 60909



DCC ON BOARD™

DIESEL LOCOMOTIVES

HO SCALE

EMD SD40-2

Performs best on 18" radius curves or greater.

Standard Pack: 6 • \$65.00 each



UNION PACIFIC® #4081
Item No. 67006



CANADIAN NATIONAL #6136
Item No. 67009



CSX® #8856
(Dark Future)
Item No. 67010



WHEELING & LAKE ERIE #7375
Item No. 67011



KANSAS CITY SOUTHERN #647
Item No. 67012



CSX® #8036
(Bright Future)
Item No. 67013

NEW

HO SCALE

DIESEL LOCOMOTIVES

GE B23-7/B30-7 with 8-WHEEL DRIVE
Performs best on 18" radius curves or greater.

Standard Pack: 6 • \$62.00 each



SANTA FE #6380
Item No. 11105



CSX® #5575
(Dark Future)
Item No. 11117



MISSOURI PACIFIC™ #4632
Item No. 11119



UNION PACIFIC® #124
Item No. 11103



CONRAIL #1991
Item No. 11107



PROVIDENCE & WORCESTER #2212
Item No. 11118



FT-A UNIT (DCC EQUIPPED)

Performs best on 18" radius curves or greater.

Standard Pack: 6 • \$79.00 each



DCC ON BOARD™ locomotives feature dual-mode digital command control decoders enabling operation with a standard DC analog power pack or any NMRA-compliant Digital Command Control system. Speed, direction, and lighting control.



BURLINGTON
Item No. 60116



DENVER & RIO GRANDE WESTERN™
Item No. 60117



ERIE
Item No. 60135



SEABOARD®
Item No. 60147

FT-B UNIT (DCC EQUIPPED)

Performs best on 18" radius curves or greater.

Standard Pack: 6 • \$79.00 each



DCC ON BOARD™ locomotives feature dual-mode digital command control decoders enabling operation with a standard DC analog power pack or any NMRA-compliant Digital Command Control system. Speed, direction, and lighting control.



BURLINGTON
Item No. 60216



DENVER & RIO GRANDE WESTERN™
Item No. 60217



ERIE
Item No. 60235



SEABOARD®
Item No. 60247

HO SCALE

DIESEL LOCOMOTIVES

EMD FT-A UNIT with 8-WHEEL DRIVE
Performs best on 18" radius curves or greater.

Standard Pack: 6 • \$50.00 each



DENVER & RIO GRANDE WESTERN™
Item No. 11703



BALTIMORE & OHIO®
Item No. 11706



ERIE
Item No. 11708

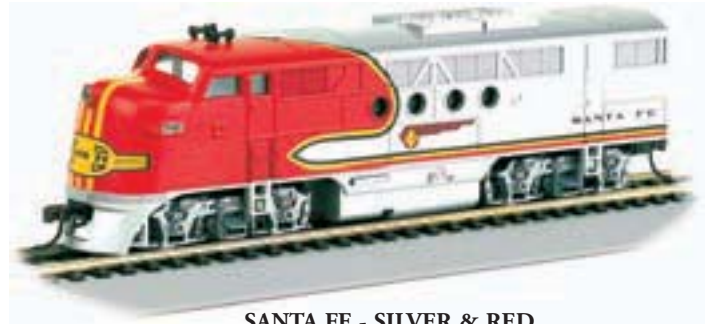

SANTA FE - SILVER & RED
Item No. 11702



SEABOARD® AIRLINE
Item No. 11705



NEW YORK CENTRAL®
(lightning stripe)
Item No. 11707



SANTA FE - BLUE & YELLOW
Item No. 11709



DIESEL LOCOMOTIVES

HO SCALE

EMD FT-B UNIT with 8-WHEEL DRIVE

Performs best on 18" radius curves or greater.

Standard Pack: 6 • \$50.00 each



SANTA FE - SILVER & RED
Item No. 11802



DENVER & RIO GRANDE WESTERN™
Item No. 11803



SEABOARD® AIRLINE
Item No. 11805



BALTIMORE & OHIO®
Item No. 11806



NEW YORK CENTRAL®
(lightning stripe)
Item No. 11807



ERIE
Item No. 11808



SANTA FE - BLUE & YELLOW
Item No. 11809

HO SCALE

DIESEL LOCOMOTIVES

FAIRBANKS-MORSE H16-44

Performs best on 18" radius curves or greater.

Standard Pack: 6 • \$77.00 each



BALTIMORE & OHIO® #927
Item No. 64112



NEW HAVEN #1603
Item No. 64128



VIRGINIAN
Item No. 64130



NORFOLK & WESTERN #146
Item No. 64142



Have a question? You can
"Ask the Bach-Man" on
our message board at
www.bachmanntrains.com!

DIESEL LOCOMOTIVES

HO SCALE

GE 70-TON DIESEL (DCC EQUIPPED)
Performs best on 18" radius curves or greater.

Standard Pack: 6 • \$79.00 each



DCC ON BOARD™ locomotives feature dual-mode digital command control decoders enabling operation with a standard DC analog power pack or any NMRA-compliant Digital Command Control system. Speed, direction, and lighting control.



SOUTHERN PACIFIC™ #5101
Item No. 60601

SOUTHERN PACIFIC™ #5106
(not shown)
Item No. 60602



LOUISVILLE & NASHVILLE® #98
Item No. 60603

LOUISVILLE & NASHVILLE® #99
(not shown)
Item No. 60604



PAINTED, UNLETTERED - YELLOW & BLACK
Item No. 60607



PAINTED, UNLETTERED - GREEN
Item No. 60608



PAINTED, UNLETTERED - RED
Item No. 60609



PAINTED, UNLETTERED - BLACK
Item No. 60610



PAINTED, UNLETTERED - ORANGE & CREAM
Item No. 60611



BETHLEHEM STEEL
Item No. 60612



HO SCALE

DIESEL LOCOMOTIVES

GE 44-TON SWITCHER (DCC EQUIPPED)

Performs best on 15" radius curves or greater.

Standard Pack: 6 • \$87.00 each

DCCTM ON BOARD



DCC ON BOARDTM locomotives feature dual-mode digital command control decoders enabling operation with a standard DC analog power pack or any NMRA-compliant Digital Command Control system. Speed, direction, and lighting control.



**PAINTED, UNLETTERED - YELLOW
with BLACK STRIPES**
Item No. 62201



PAINTED, UNLETTERED - BLACK
Item No. 62202



**BOSTON & MAINE #114
(Minuteman)**
Item No. 62206

NEW

BOSTON & MAINE #119
(McGinnis; blue & white; not shown)
Item No. 62207



NEW

SANTA FE #463
(zebra stripe)
Item No. 62208



NEW

PENNSYLVANIA #9334
Item No. 62209



NEW

DENVER & RIO GRANDE WESTERNTM #36
Item No. 62210



MDT PLYMOUTH

Performs best on 15" radius curves or greater.

Standard Pack: 6 • \$50.00 each



SANTA FE #32
Item No. 60002

DCC ON BOARDTM

STREETCARS

HO SCALE

PCC STREETCAR with die-cast power truck
Performs best on 15" radius curves or greater.

Standard Pack: 12 • \$47.00 each



LOS ANGELES RAILWAY
Item No. 62931



BROOKLYN & QUEENS TRANSIT
Item No. 62932



ST. LOUIS RAILWAYS
Item No. 62933



CHICAGO SURFACE LINES
Item No. 62934



TORONTO TRANSIT
Item No. 62935



WASHINGTON D.C. TRANSIT
Item No. 62936



PHILADELPHIA TRANSIT COMPANY
Item No. 62945



BALTIMORE TRANSIT COMPANY
Item No. 62947

HO SCALE

TROLLEY AND CABLE CARS

BRILL TROLLEY with die-cast power truck
Performs best on 15" radius curves or greater.

Standard Pack: 12 • \$43.00 each



DESIRE
Item No. 61036



CHRISTMAS
Item No. 61040

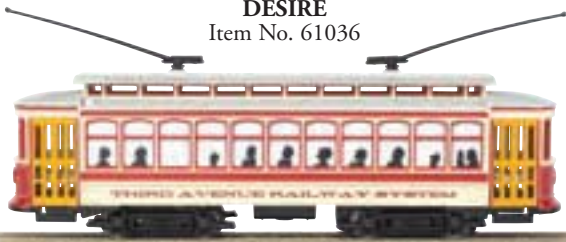

THIRD AVENUE NEW YORK CITY
Item No. 61042



GREEN
Item No. 61043



MAIN STREET
Item No. 61047



YELLOW #36
Item No. 61048

CABLE CAR

Performs best on 15" radius curves or greater.

Standard Pack: 12 • \$50.00 each



CABLE CAR - RED
Item No. 60530



CABLE CAR - GREEN
Item No. 60531



CABLE CAR - BLUE
Item No. 60532



BALTIMORE
(not shown)
Item No. 60533

POWERED VEHICLES

“GANDY DANCER” OPERATING HAND CAR

Performs best on 15" radius curves or greater.

Standard Pack: 12 • \$43.00 each



ASSORTED COLORS

Item No. 46202



CHRISTMAS

Item No. 46210

HIGH RAILER - MAINTENANCE OF WAY VEHICLES

Performs best on 15" radius curves or greater.

Standard Pack: 12 • \$56.00 each



PICK-UP TRUCK with HIGH RAILERS

Item No. 46201



RAIL DETECTOR STEP VAN with HIGH RAILERS

Item No. 46204



1950s 4 x 4 with HIGH RAILERS

Item No. 46207



BUS with HIGH RAILERS

Item No. 46211

85' BUDD AMTRAK PASSENGER CAR with LIGHTED INTERIOR

Standard Pack: 6 • \$43.00 each



AMFLEET I PHASE II COACH
Item No. 13106



AMFLEET I PHASE II CAFÉ
Item No. 13110



AMFLEET I PHASE III COACH
Item No. 13107



AMFLEET I PHASE III CAFÉ
Item No. 13111



AMFLEET I PHASE IV COACH
Item No. 13108



AMFLEET I PHASE IV CAFÉ
Item No. 13112



AMFLEET I PHASE IV B COACH
Item No. 13114



The *Silver Series*® rolling stock on these pages feature:

- blackened metal wheels
- body-mounted couplers
- non-magnetic axles

(all cars on these pages Standard Pack: 12; unless noted otherwise)



AMFLEET I PHASE V COACH
Item No. 13116



AMFLEET I ACELA® REGIONAL COACH
Item No. 13109

DOUBLE DECK PUSH/PULL COMMUTER CAR

Standard Pack: 4 • \$46.00 each

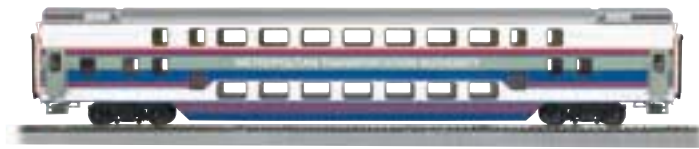

METROPOLITAN TRANSPORTATION AUTHORITY
Item No. 13246



PAINTED, UNLETTERED - RED, WHITE & BLUE
Item No. 13247



**PAINTED, UNLETTERED - SILVER
with RED & BLUE STRIPES**
Item No. 13248

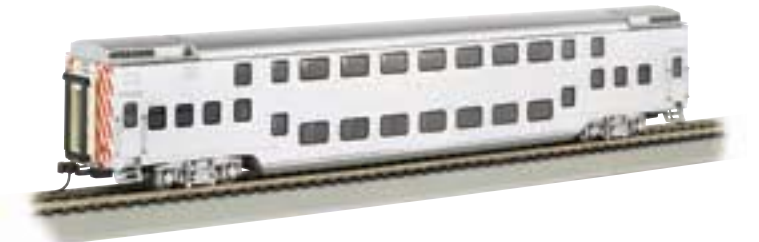

PAINTED, UNLETTERED - SILVER
Item No. 13249

**89' COLORADO RAILCAR FULL-DOME PASSENGER CAR
with LIGHTED INTERIOR**

Performs best on 22" radius curves or greater.

Standard Pack: 4 • \$53.00 each



89' MCKINLEY EXPLORER "CHENA" #1052
(A Car)
Item No. 13341



89' MCKINLEY EXPLORER "NENANA" #1055
(B Car)
Item No. 13342



89' MCKINLEY EXPLORER "EKLUTNA" #1054
(A Car; not shown)
Item No. 13343



89' MCKINLEY EXPLORER "TALKEETNA" #1057
(B Car; not shown)
Item No. 13344

85' BUDD FULL-DOME PASSENGER CAR with LIGHTED INTERIOR

Standard Pack: 6 • \$41.00 each



AMTRAK PHASE I
Item No. 13005



AMTRAK PHASE II
Item No. 13032



McKINLEY EXPLORER
Item No. 13037



SANTA FE
Item No. 13002



GREAT NORTHERN
Item No. 13011



ROYAL GORGE
Item No. 13035



NORFOLK SOUTHERN
Item No. 13047

85' SMOOTH-SIDE FULL-DOME PASSENGER CAR with LIGHTED INTERIOR

Standard Pack: 6 • \$41.00



SOUTHERN PACIFIC™
Item No. 13007



The *Silver Series*® rolling stock on these pages feature:

- blackened metal wheels
- body-mounted couplers
- non-magnetic axles

(all cars on these pages Standard Pack: 12; unless noted otherwise)

OPEN-SIDED EXCURSION CARS with SEATS

Standard Pack: 12 • \$32.00 each



DURANGO & SILVERTON
Item No. 17432

NEW

ROYAL GORGE
(not shown)
Item No. 17435

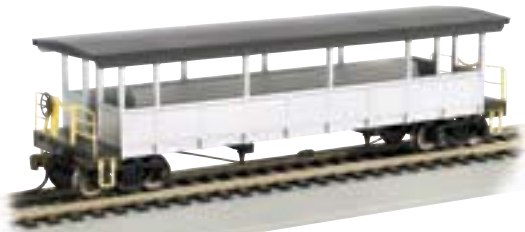

PAINTED, UNLETTERED - SILVER & BLACK
Item No. 17447



CASS SCENIC RAILROAD
Item No. 17445



PAINTED, UNLETTERED - RED, GREEN & GOLD
Item No. 17449



PAINTED, UNLETTERED - SILVER & YELLOW
Item No. 17448

JACKSON SHARP OPEN-SIDED EXCURSION CARS

Standard Pack: 12 • \$41.00 each

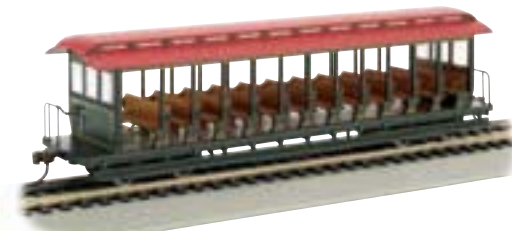

PAINTED, UNLETTERED - GREEN & RED
Item No. 19346

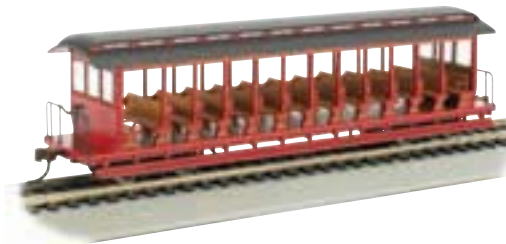

PAINTED, UNLETTERED - BURGUNDY & BLACK
Item No. 19347

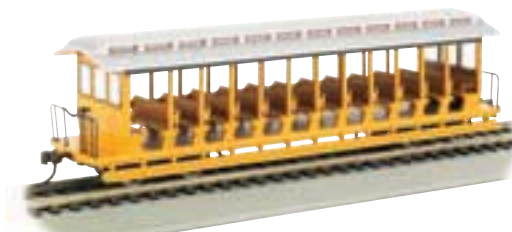

PAINTED, UNLETTERED - YELLOW & SILVER
Item No. 19348

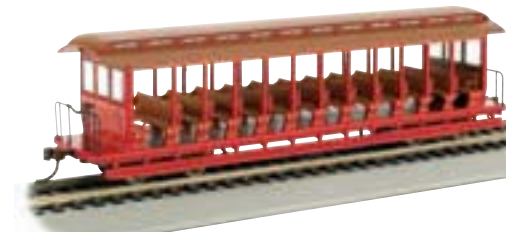

PAINTED, UNLETTERED - RED & BROWN
Item No. 19349

1860-1880 PASSENGER CARS

Standard Pack: 12 • \$21.00

NEW

COACH - DURANGO & SILVERTON
(yellow, black & silver; not shown)
Item No. 13401

NEW

COMBINE - DURANGO & SILVERTON
(yellow, black & silver; not shown)
Item No. 13501

55-TON 2-BAY USRA OUTSIDE BRACED HOPPER with REMOVABLE COAL LOAD

Standard Pack: 12 • \$24.00 each



PENNSYLVANIA
Item No. 19501



CHESAPEAKE & OHIO®
Item No. 19502



BALTIMORE & OHIO®
(Capitol Dome)
Item No. 19503



WESTERN MARYLAND®
(speed lettering)
Item No. 19504



DELAWARE & HUDSON
Item No. 19505



CLINCHFIELD
Item No. 19506

50' SLIDING DOOR BOX CAR

Standard Pack: 12 • \$24.00 each



CENTRAL OF GEORGIA
(with roof walk)
Item No. 19401



NEW YORK CENTRAL®
(with roof walk)
Item No. 19402



DELAWARE & HUDSON
(I Love New York; without roof walk)
Item No. 19405



SANTA FE
(with roof walk)
Item No. 19406



ATLANTIC COAST LINE
(with roof walk)
Item No. 19407



UNION PACIFIC®
(without roof walk)
Item No. 19408



The *Silver Series*® rolling stock on these pages feature:

- blackened metal wheels
- body-mounted couplers
- non-magnetic axles

(all cars on these pages Standard Pack: 12; unless noted otherwise)

HO SCALE

SILVER SERIES® ROLLING STOCK

40' BOX CAR

Standard Pack: 12 • \$20.00 each



SOUTHERN
Item No. 17004



PRR MERCHANDISE SERVICE
Item No. 17014



LEHIGH VALLEY
Item No. 17023



CHICAGO & ILLINOIS MIDLAND
Item No. 17025



NEW HAVEN - MCGINNIS
Item No. 17027



NASHVILLE, CHATTANOOGA & ST. LOUIS
Item No. 17030



NEW HAVEN - RED
Item No. 17031



TOLEDO, PEORIA & WESTERN
Item No. 17032



BANGOR & AROOSTOOK
Item No. 17038



WESTERN MARYLAND® #25124
Item No. 17041



TORONTO, HAMILTON & BUFFALO
Item No. 17043



LACKAWANNA
(Phoebe Snow)
Item No. 17044



SEABOARD®
Item No. 17046



BOSTON & MAINE
Item No. 17048



The *Silver Series*® rolling stock on these pages feature:

- blackened metal wheels
- body-mounted couplers
- non-magnetic axles

(all cars Standard Pack: 12)

50' PLUG-DOOR BOX CAR

Standard Pack: 12 • \$19.00 each



SANTA FE
Item No. 18002



CONRAIL
Item No. 18006



BALTIMORE & OHIO® - YELLOW with BLUE
Item No. 18012



BALTIMORE & OHIO® - BLUE with YELLOW
Item No. 18015



NEW YORK CENTRAL®
Item No. 18020



FRISCO
Item No. 18025

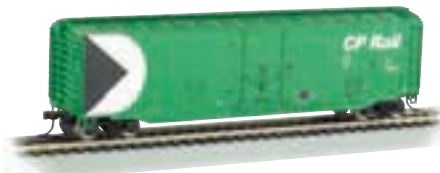

CP RAIL
Item No. 18027



WESTERN MARYLAND®
Item No. 18037

50' STEEL REEFER

Standard Pack: 12 • \$19.00 each



UNION PACIFIC®
Item No. 17901



SANTA FE
Item No. 17902



BURLINGTON NORTHERN
Item No. 17903



CANADIAN NATIONAL
Item No. 17913



MILWAUKEE ROAD
Item No. 17917



NEW YORK CENTRAL®
Item No. 17920



FRUIT GROWER'S EXPRESS®
Item No. 17940



**AMERICAN REFRIGERATOR
TRANSPORT™**
Item No. 17941



TROPICANA
Item No. 17947

HO SCALE

SILVER SERIES® ROLLING STOCK

CANADIAN 4-BAY CYLINDRICAL GRAIN HOPPER

\$20.00 each



SANTA FE
Item No. 19102



GREAT NORTHERN
Item No. 19111



CANADIAN NATIONAL
Item No. 19113



CANADIAN PACIFIC
Item No. 19129



CANADA GRAIN
Item No. 19131

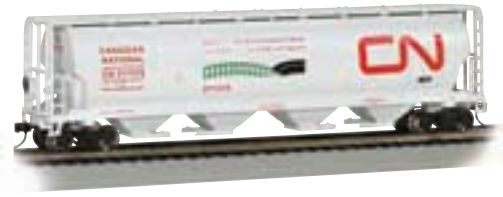

CN ENVIRONMENTAL MODE
Item No. 19132



CANADIAN NATIONAL - DEMONSTRATOR
Item No. 19133



GOVERNMENT OF CANADA - RED
Item No. 19134



GOVERNMENT OF CANADA - YELLOW
Item No. 19136



ALBERTA/EDMONTON
Item No. 19138



HERITAGE FUND
Item No. 19139



SASKATCHEWAN - WHEAT HERALD
Item No. 19140



POTACAN
Item No. 19141



CANADIAN PACIFIC
Item No. 19142

NEW
POTASH CORPORATION
(orange; not shown)
Item No. 19143



The *Silver Series*® rolling stock on these pages feature:

- blackened metal wheels
- body-mounted couplers
- non-magnetic axles

(all cars on these pages
Standard Pack: 12; unless
noted otherwise)

56' ACF CENTER-FLOW HOPPER

\$20.00 each



SANTA FE
Item No. 17502



CONRAIL
Item No. 17506



CSX®
Item No. 17518



NEW YORK CENTRAL® - JADE GREEN
Item No. 17520



NEW YORK CENTRAL® - GRAY
Item No. 17523



ERIE LACKAWANNA
Item No. 17528



CP RAIL
(not shown)
Item No. 17529



CARGILL SALT
Item No. 17531



DT & I
Item No. 17532

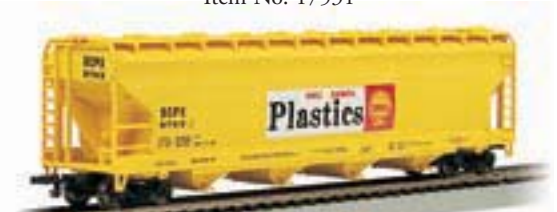

SHELL
Item No. 17534



OMYA
Item No. 17546



MONSANTO
Item No. 17547

HO SCALE

SILVER SERIES® ROLLING STOCK

52' CENTER-DEPRESSED FLAT CAR

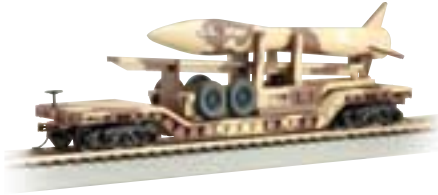

DESERT MILITARY with MISSILE
Item No. 18344 • \$25.00



OLIVE DRAB MILITARY with MISSILE
Item No. 18345 • \$25.00



with BOILER
Item No. 18346 • \$24.00



with MISSILE
Item No. 18347 • \$25.00

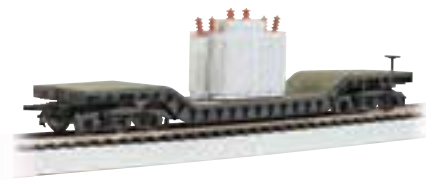

with TRANSFORMER
Item No. 18348 • \$21.00



with NO LOAD
Item No. 18349 • \$20.00

40' THREE-DOME TANK CAR

\$18.50 each



PENNSALT CHEMICAL
Item No. 17127



PHILADELPHIA QUARTZ COMPANY
Item No. 17128



DEEP ROCK
Item No. 17130



SHELL
Item No. 17134



QUAKER STATE
Item No. 17137



PANHANDLE REFINING CO.
Item No. 17139



PHILLIPS 66
Item No. 17140



NORTHERN CALIFORNIA WINERIES
Item No. 17141



TRANSCONTINENTAL OIL CO.
Item No. 17142



CHEMCELL
Item No. 17143



CARBIDE and CARBON CHEMICALS
Item No. 17144



CHRISTMAS "EGGNOG"
Item No. 17148

NEW

NEW

NEW

52' FLAT CAR

\$18.50 each



UNION PACIFIC®
Item No. 17301



SANTA FE
Item No. 17302



PENNSYLVANIA
Item No. 17314



CHESAPEAKE & OHIO®
Item No. 17322



WESTERN PACIFIC™
Item No. 17325



DELAWARE & HUDSON
Item No. 17326



NORTHERN PACIFIC
Item No. 17333



WESTERN MARYLAND®
Item No. 17334



NORFOLK & WESTERN
Item No. 17342



The *Silver Series*® rolling stock on these pages feature:

- blackened metal wheels
- body-mounted couplers
- non-magnetic axles (all cars on these pages Standard Pack: 12)

40' GONDOLA

\$17.50 each



UNION PACIFIC®
Item No. 17201



SOUTHERN
Item No. 17204



GREAT NORTHERN
Item No. 17211



CANADIAN NATIONAL
Item No. 17213



PENNSYLVANIA
Item No. 17214



NEW HAVEN
Item No. 17231



LEHIGH & NEW ENGLAND
Item No. 17233



NICKEL PLATE ROAD
Item No. 17235



NORFOLK & WESTERN
Item No. 17242

HO SCALE

SILVER SERIES® ROLLING STOCK

TRACK CLEANING TANK CAR

Standard Pack: 12 • \$40.00 each



MAINTENANCE OF WAY
Item No. 16301



UTLX
Item No. 16302



UNLETTERED - OXIDE RED
Item No. 16303



UNLETTERED - SILVER
Item No. 16304

40' SINGLE-DOME TANK CAR

Standard Pack: 12 • \$18.50 each



PENNSALT
Item No. 17825



FRONTENAC
Item No. 17826



TEXACO
Item No. 17828



GRAMPS
Item No. 17832



SHELL
Item No. 17834



QUAKER STATE
Item No. 17837



EXXON
Item No. 17838



PHILLIPS 66
Item No. 17840



OWENWOOD MOTOR OIL
Item No. 17845



GRAMS
Item No. 17846



C. F. SIMONIN'S SONS, INC.
Item No. 17847



SPARTON OIL COMPANY
Item No. 17848



ACF 40' LOG CAR with LOGS

Standard Pack: 12 • \$47.00 each



1906-1935 VERSION
Item No. 18332



1935-1960 VERSION
Item No. 18849



Die-cast car with painted resin logs

ACF 40' LOG CAR with LOG SKIDDER and CRATES

Standard Pack: 12 • \$41.00

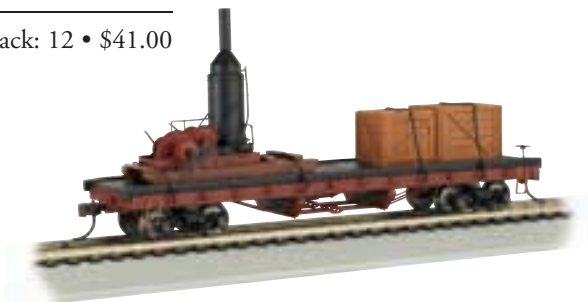

NON-OPERATING LOG SKIDDER and CRATES on 40' LOG CAR
Item No. 18301

LOG SKIDDER

Standard Pack: 12 • \$24.00



LOG SKIDDER
(non-operating; 2 per card)
Item No. 18302

250-TON STEAM CRANE & BOOM TENDER

Crane swivels 360°. Removable knob included for adjusting boom position.

Standard Pack: 12 • \$46.00 each



SANTA FE
Item No. 16102



READING
Item No. 16110



PENNSYLVANIA
Item No. 16114



CHESAPEAKE & OHIO®
Item No. 16122



MAINTENANCE OF WAY
Item No. 16138



PAINTED, UNLETTERED
Item No. 16149

40' STOCK CAR

Standard Pack: 12 • \$18.50 each



UNION PACIFIC®
Item No. 18501



SANTA FE
Item No. 18502



SOUTHERN PACIFIC™
Item No. 18507



BALTIMORE & OHIO®
Item No. 18512



NEW YORK CENTRAL®
Item No. 18520



CANADIAN PACIFIC
Item No. 18524

NEW

CP RAIL
(not shown)
Item No. 18527



NORTHERN PACIFIC
Item No. 18535

50' HUMANE LIVESTOCK CAR

Standard Pack: 12 • \$20.00

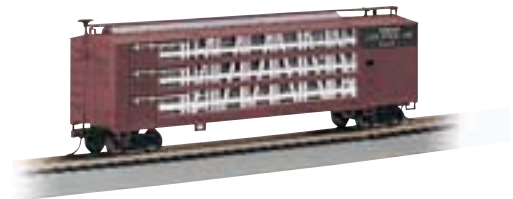

Item No. 18549

ORE CAR

Standard Pack: 12 • \$17.50 each



UNION PACIFIC®
Item No. 18601



CONRAIL
Item No. 18606



PENNSYLVANIA
Item No. 18614



L S & I
Item No. 18629

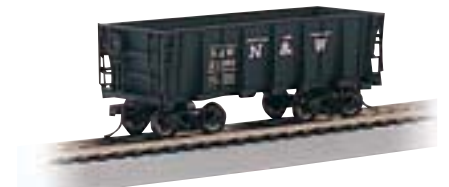

NORFOLK & WESTERN
Item No. 18642



DULUTH, MISSABE & IRON RANGE
MINERAL RED
Item No. 18644

SILVER SERIES® ROLLING STOCK

HO SCALE

BETHLEHEM STEEL 100-TON THREE-BAY HOPPER

Standard Pack: 12 • \$24.00 each



UNION PACIFIC® #36255
Item No. 18702



BURLINGTON NORTHERN #542979
Item No. 18704



READING #41427
Item No. 18711



PENNSYLVANIA - YELLOW BALL #180658
Item No. 18714



CHESAPEAKE & OHIO® #78951
Item No. 18723



CLINCHFIELD® #56841
Item No. 18732



NORTHERN PACIFIC #73688
Item No. 18735

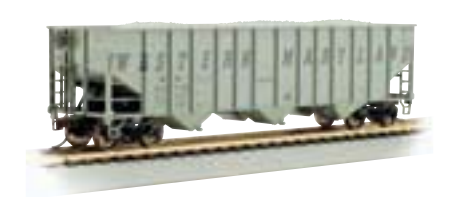

WESTERN MARYLAND® #63834
Item No. 18737



NORFOLK SOUTHERN #144913
Item No. 18741

WESTERN MARYLAND® #63787
Item No. 18738

NORFOLK SOUTHERN #144927
Item No. 18743

EVANS ALL-DOOR BOX CAR

Standard Pack: 12 • \$20.00 each



SOUTHERN
Item No. 18104



SANTA FE #3787
Item No. 18105



SOUTHERN PACIFIC™
Item No. 18107



CANADIAN FOREST #4540
Item No. 18135



TRIANGLE PACIFIC
Item No. 18138



The *Silver Series*® rolling stock on these pages feature:

- blackened metal wheels
- body-mounted couplers
- non-magnetic axles

(all cars on these pages Standard Pack: 12; unless noted otherwise)

FLAT CAR with LOAD

Standard Pack: 12 • \$25.00 each



MAINE CENTRAL with CONTAINER LOAD
Item No. 18901

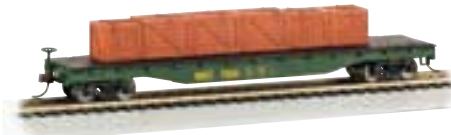

MAINE CENTRAL with CRATED LOAD
Item No. 18902

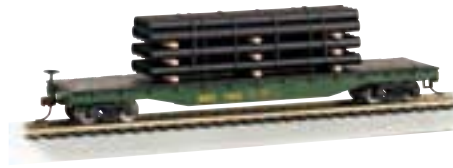

MAINE CENTRAL with PIPE LOAD
Item No. 18903



MAINE CENTRAL with STEEL LOAD
Item No. 18904



PENNSYLVANIA RAILROAD with CONTAINER LOAD
Item No. 18906



PENNSYLVANIA RAILROAD with CRATED LOAD
Item No. 18907

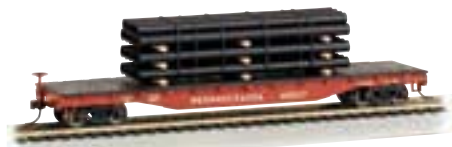

PENNSYLVANIA RAILROAD with PIPE LOAD
Item No. 18908



PENNSYLVANIA RAILROAD with STEEL LOAD
Item No. 18909



SANTA FE with CONTAINER LOAD
Item No. 18911



SANTA FE with CRATED LOAD
Item No. 18912

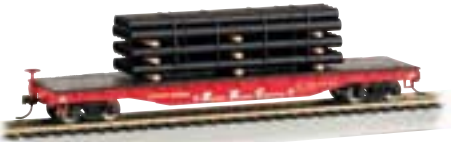

SANTA FE with PIPE LOAD
Item No. 18913



SANTA FE with STEEL LOAD
Item No. 18914

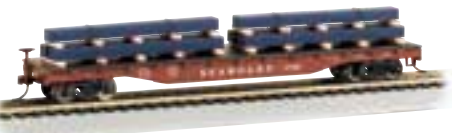

SEABOARD® with STEEL LOAD
Item No. 18919



UNION PACIFIC® with CONTAINER LOAD
Item No. 18921



UNION PACIFIC® with CRATED LOAD
Item No. 18922

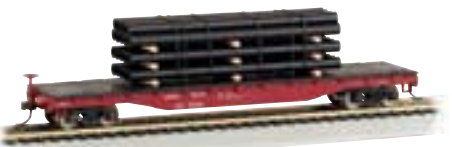

UNION PACIFIC® with PIPE LOAD
Item No. 18923

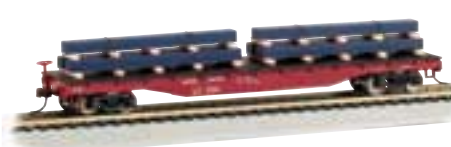

UNION PACIFIC® with STEEL LOAD
Item No. 18924



WESTERN MARYLAND® with CONTAINER LOAD
Item No. 18926

FLAT CAR with LOAD (continued)

Standard Pack: 12 • \$25.00 each



**WESTERN MARYLAND®
with CRATED LOAD**
Item No. 18927

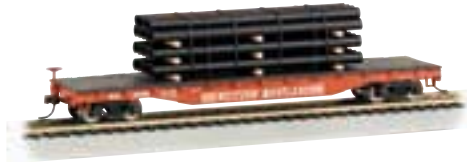

**WESTERN MARYLAND®
with PIPE LOAD**
Item No. 18928

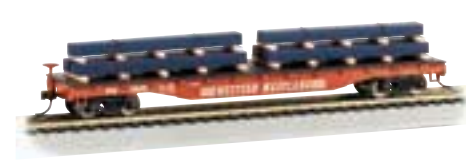

**WESTERN MARYLAND®
with STEEL LOAD**
Item No. 18929

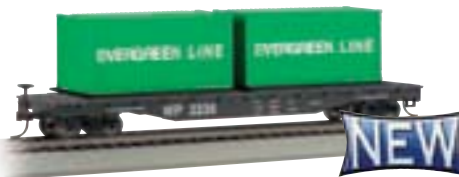

**WESTERN PACIFIC
with CONTAINER LOAD**
Item No. 18931



**WESTERN PACIFIC
with CRATED LOAD**
Item No. 18932



WESTERN PACIFIC with PIPE LOAD
Item No. 18933

40' QUAD HOPPER

Standard Pack: 12 • \$17.50 each

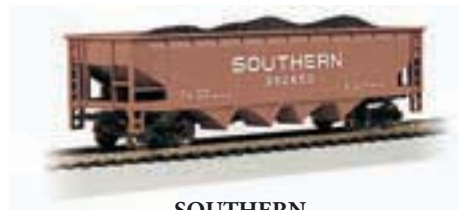

SOUTHERN
Item No. 17604



BALTIMORE & OHIO®
Item No. 17612



PENNSYLVANIA
Item No. 17614



CSX®
Item No. 17618



NEW YORK CENTRAL®
Item No. 17620



CHESAPEAKE & OHIO®
Item No. 17622



NORFOLK & WESTERN
Item No. 17642



SEABOARD®
Item No. 17647



BALTIMORE & OHIO® - LARGE LETTERING
Item No. 17648

HO SCALE

SILVER SERIES® ROLLING STOCK

BOBBER CABOOSE

\$17.50 each



UNION PACIFIC®
Item No. 18401

NEW

PENNSYLVANIA
(not shown)
Item No. 18414

NEW

DURANGO & SILVERTON
(not shown)
Item No. 18432



MARYLAND & PENNSYLVANIA
Item No. 18439



CASS SCENIC R.R.
Item No. 18445



PAINTED, UNLETTERED - RED
Item No. 18449

36' WIDE-VISION CABOOSE

\$17.50 each



UNION PACIFIC®
Item No. 17701



SANTA FE
Item No. 17702



BURLINGTON NORTHERN
Item No. 17703

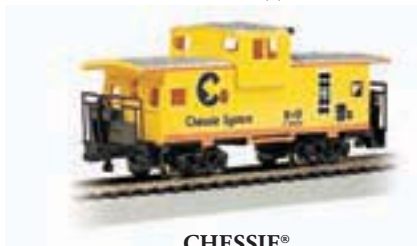

CHESSIE®
Item No. 17709



READING
Item No. 17710

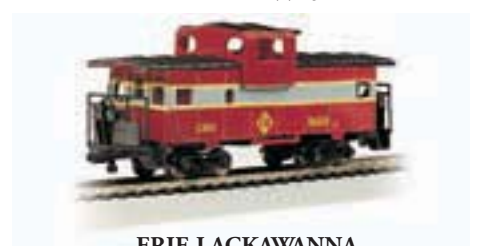

ERIE LACKAWANNA
Item No. 17728



The *Silver Series*® rolling stock on this page features:

- blackened metal wheels
- body-mounted couplers
- non-magnetic axles

(all cars on this page
Standard Pack: 12)



Magnetically Operated Knuckle Couplers

E-Z Mate® couplers make use of precision molding techniques and space-age material to allow the molding of springs as an integral part of the knuckle coupler. With *E-Z Mate*® couplers, gone forever are the problems and expense associated with separate coil springs.

The installation of *E-Z Mate*® couplers is a dream come true. It's simply a matter of removing the coupler pocket cover, dropping in an *E-Z Mate*® coupler, and replacing the cover. Operation is simple as well. *E-Z Mate*® couplers operate with a standard metal "glad hand" and under-track magnet, and they are completely compatible with all magnetically operated knuckle couplers currently on the market. (Our under-track magnet comes with a trackside brakeman figure to indicate the magnet's position.) Coupling, uncoupling, and other yard operations are all performed with familiar ease.



E-Z MATE® Magnetic Knuckle Couplers

Standard Pack: 12 cards with 12 coupler pairs per card • \$16.50 each card
Item No. 78005 **Center Shank - Medium**



E-Z MATE® Magnetic Knuckle Couplers - Economy Pack

Standard Pack: 12 cards with 25 coupler pairs per card • \$27.50 each card
Item No. 78105 **Center Shank - Medium**



E-Z MATE® MARK II Magnetic Knuckle Couplers with Metal Coil Springs

Standard Pack: 12 cards with 12 coupler pairs per card • \$23.00 each card

- Item No. 78021 **Over Shank - Long**
- Item No. 78022 **Over Shank - Medium**
- Item No. 78023 **Over Shank - Short**
- Item No. 78024 **Center Shank - Long**
- Item No. 78025 **Center Shank - Medium**
- Item No. 78026 **Center Shank - Short**
- Item No. 78027 **Under Shank - Long**
- Item No. 78028 **Under Shank - Medium**
- Item No. 78029 **Under Shank - Short**



E-Z MATE® MARK II Magnetic Knuckle Couplers with Metal Coil Springs - Economy Pack

Standard Pack: 12 cards with 25 coupler pairs per card • \$38.50 each card
Item No. 78125 **Center Shank - Medium**

NEM COUPLER (E-Z MATE® MARK II)

Standard Pack: 12 cards with 12 coupler pairs per card • \$23.00 each card



This NEM Mark II coupler fits into standard European coupler pockets for simple conversion to *E-Z Mate*® operation.

Item No. 78035 **Center Shank - Medium**

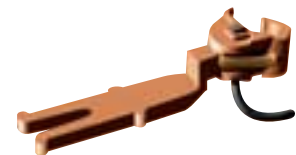

MAGNET with BRAKEMAN (1/card)

Item No. 78999 • Standard Pack: 24 • \$3.85



HOOK-AND-LOOP COUPLERS (3 pairs per pack)

Item No. 78979 • Standard Pack: 12 • \$9.00

These couplers are compatible with most of our *Thomas & Friends*™ products and many European prototype models.



Plasticville® U.S.A.



HO SCALE PLASTICVILLE® U.S.A. BUILT-UPS

Standard Pack: 6

Since 1947, hobbyists and collectors have made *Plasticville® U.S.A.* products their structures of choice. Now, in addition to our traditional, easy-to-assemble kits, Bachmann is pleased to offer these pre-assembled *Plasticville® U.S.A.* buildings.

Plasticville® pieces add character and dimension to your HO scale layout. Many buildings and accessories have been added to the *Plasticville®* line throughout its history, and many are still produced from their original molds. As a fun challenge to collectors you can collect hundreds of product, color, and packaging variations that have occurred over the years (you can even join the independent Plasticville Collectors Association at plasticvilleusa.org). Whether you're new in town or an established civic leader, Bachmann builds *Plasticville® U.S.A.* for you. City growth is limited only by your imagination!



SIGNAL BRIDGE
(two per box)
Item No. 45001 • \$39.50



COALING STATION
Item No. 45002 • \$35.00



PEDESTRIAN BRIDGE
Item No. 45003 • \$33.00



**HOUSE UNDER
CONSTRUCTION**
Item No. 45004 • \$33.00



SPLIT-LEVEL HOUSE
Item No. 45005 • \$37.00



**FREIGHT STATION
with PLATFORM STATION**
Item No. 45006 • \$37.00



DAIRY BARN
Item No. 45007 • \$33.00



WATER TOWER
Item No. 45008 • \$26.50



RAILROAD WORK SHEDS
(two per box)
Item No. 45009 • \$37.00



COVERED BRIDGE
Item No. 45010 • \$30.00



SCHOOL HOUSE
Item No. 45011 • \$30.00



CATHEDRAL
Item No. 45012 • \$30.00



GAS STATION
Item No. 45013 • \$37.00



HO
SCALE

PLASTICVILLE® U.S.A. KITS

Plasticville

U.S.A.



HO PLASTICVILLE® U.S.A. BUILDINGS (CLASSIC KITS)

Standard Pack: 12



CAPE COD HOUSE
Item No. 45131 • \$14.00



SCHOOL HOUSE
Item No. 45133 • \$14.00



SUPERMARKET
Item No. 45141 • \$14.00



5 & 10 STORE
Item No. 45142 • \$14.00



HARDWARE STORE
Item No. 45143 • \$14.00



POST OFFICE
Item No. 45144 • \$14.00



SWITCH TOWER
Item No. 45132 • \$14.00



SIGNAL BRIDGE
Item No. 45134 • \$14.00



WATER TANK
Item No. 45153 • \$15.50



CATHEDRAL
Item No. 45192 • \$17.50



COALING STATION
Item No. 45211 • \$20.00



POLICE STATION
Item No. 45145 • \$14.00



BARN
Item No. 45151 • \$15.50



FARM BUILDINGS with ANIMALS
Item No. 45152 • \$15.50



RANCH HOUSE
Item No. 45154 • \$15.50

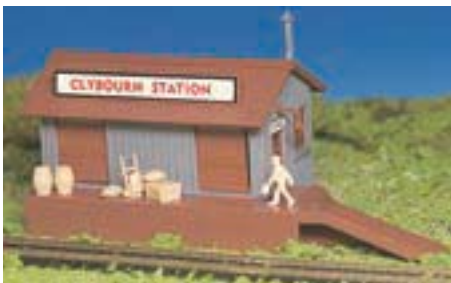

FREIGHT STATION
Item No. 45171 • \$16.50



PEDESTRIAN BRIDGE
Item No. 45172 • \$16.50



SUBURBAN STATION
Item No. 45173 • \$16.50



GAS STATION
Item No. 45174 • \$20.00



HOUSE UNDER CONSTRUCTION
Item No. 45191 • \$17.50



PLATFORM STATION
Item No. 45194 • \$17.50



SPLIT-LEVEL HOUSE
Item No. 45213 • \$20.00



MOTEL with POOL
Item No. 45214 • \$20.00



CONTEMPORARY HOUSE
Item No. 45432 • \$23.00



DRIVE-IN BURGER STAND
Item No. 45434 • \$23.00

HO SCALE

OPERATING AND CARDED ACCESSORIES



You can add diesel horn and steam whistle sound, lights, and water features to your railroad with the accessories found in this section.



DIESEL HORN in OIL STORAGE TANK
Item No. 46208 • Standard Pack: 12 • \$36.00



STORAGE BUILDING with STEAM WHISTLE SOUND
Item No. 46209 • Standard Pack: 12 • \$36.00



OIL STORAGE TANK with LED LIGHT
Item No. 46212 • Standard Pack: 12 • \$24.00



LIGHTED FREIGHT STATION
Item No. 46216 • Standard Pack: 12 • \$27.50



LIGHTED PASSENGER STATION
Item No. 46217 • Standard Pack: 12 • \$27.50

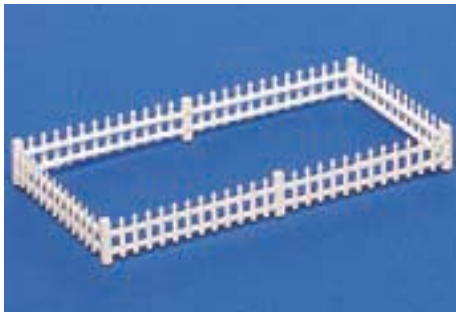

PICKET FENCE (24 pcs.)
Item No. 42100 • Standard Pack: 24 • \$8.50



BLOCK SIGNALS
Item No. 42101 • Standard Pack: 24 • \$8.50

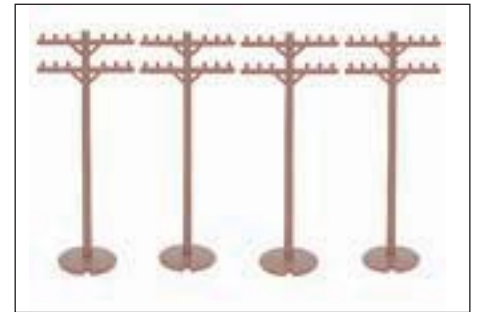

TELEPHONE POLES (12 pcs.)
Item No. 42102 • Standard Pack: 24 • \$8.50



CROSSING SIGNALS & GATES (12 pcs.)
Item No. 42200 • Standard Pack: 24 • \$8.50



RAILROAD & STREET SIGNS (24 pcs.)
Item No. 42204 • Standard Pack: 24 • \$8.50

CARDED ACCESSORIES



AUTOMOBILE SET (6 pcs.)
Item No. 42206 • Standard Pack: 24 • \$8.50



SIGNS & TRAFFIC LIGHTS (12 pcs.)
Item No. 42207 • Standard Pack: 24 • \$8.50



ROAD CROSSING
Item No. 42208 • Standard Pack: 24 • \$8.50



PARK ASSORTMENT
Item No. 42209 • Standard Pack: 24 • \$8.50



PICNIC SET
Item No. 42213 • Standard Pack: 24 • \$8.50



PLAYGROUND EQUIPMENT
Item No. 42214 • Standard Pack: 24 • \$8.50



SWIMMING POOL and ACCESSORIES
Item No. 42215 • Standard Pack: 24 • \$8.50



CENTER SQUARE MONUMENT
Item No. 42218 • Standard Pack: 24 • \$8.50



16v MINI WATER PUMP
Item No. 42219 • Standard Pack: 24 • \$17.50

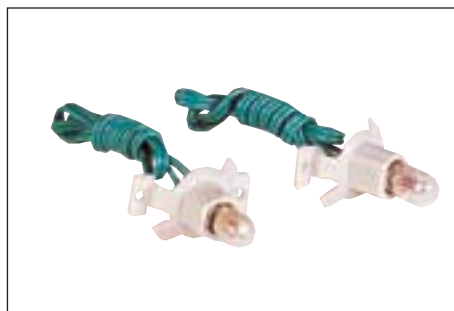

LIGHTING KIT
Item No. 42240
Standard Pack: 24 • \$8.50

MOTORIZED TURNTABLE

Item No. 46299 • Standard Pack: 2 • \$140.00 each



This DCC-ready HO scale motorized turntable includes 16 indexed track positions, gear drive, and direction control switch for easy operation on your railroad.

Features:

- 16 nickel silver track positions
- gear drive
- spring-loaded direction switch
- turntable indexed to each track section for accurate alignment
- DCC-ready with 8-pin dummy plug
- painted maintenance building
- prototypical operator's cabin
- designed for use with Bachmann's *E-Z Track*®
- easily adaptable to other popular track systems

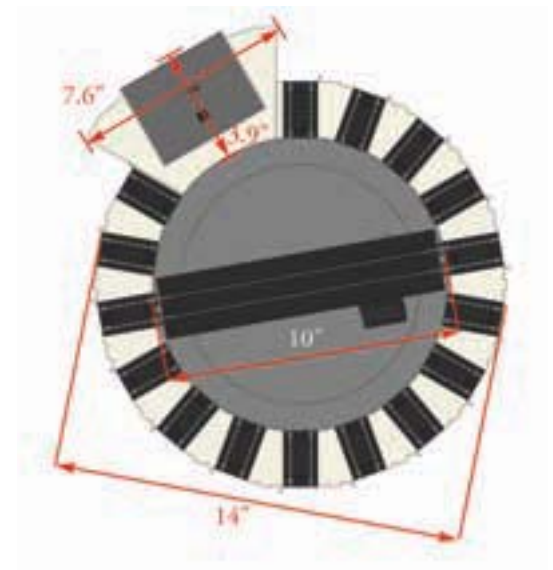

(Note: Locomotive not included)

**Bachmann's exclusive E-Z Track® System makes set-up quick, easy and fun!
See Following Pages for Product Photographs**



BULK PACK
36" LONG STRAIGHT
(25/box)
Item No. 44584

NICKEL SILVER/GRAY ROADBED E-Z TRACK® BY THE CARD		unless otherwise noted, Standard Pack: 12
Item No. 44501	18" RADIUS CURVED TRACK (4/card)	\$13.50
Item No. 44502	18" RADIUS CURVED TERMINAL RERAILER with WIRE (1/card)	\$10.25
Item No. 44503	22" RADIUS CURVED TRACK (4/card)	\$18.50
Item No. 44504	33.25" RADIUS 18 DEGREE CURVED TRACK (5/card)	\$20.00
Item No. 44505	15" RADIUS CURVED TRACK (4/card)	\$14.50
Item No. 44506	28" RADIUS 18 DEGREE CURVED TRACK (5/card)	\$18.50
Item No. 44507	35.50" RADIUS 18 DEGREE CURVED TRACK (5/card)	\$20.00
Item No. 44508	33.25" RADIUS 6 DEGREE CURVED TRACK (4/card)	\$16.00
Item No. 44509	33.25" RADIUS 12 DEGREE CURVED TRACK (4/card)	\$16.00
Item No. 44510	9" STRAIGHT TERMINAL RERAILER with WIRE (1/card)	\$10.25
Item No. 44511	9" STRAIGHT TRACK (4/card)	\$13.50
Item No. 44512	3" STRAIGHT TRACK (4/card)	\$9.25
Item No. 44513	2.25" STRAIGHT TRACK (4/card)	\$9.25
Item No. 44514	4.50" STRAIGHT TRACK (4/card)	\$10.25
Item No. 44519	26" RADIUS CURVED TRACK (5/card)	\$18.50
Item No. 44528	9" STRAIGHT RERAILER (2/card)	\$9.25
Item No. 44529	18" RADIUS CURVED RERAILER (2/card)	\$9.25
Item No. 44530	ONE-THIRD SECTION 18" RADIUS CURVED TRACK (4/card)	\$9.25
Item No. 44531	HALF SECTION 18" RADIUS CURVED TRACK (4/card)	\$9.25
Item No. 44532	HALF SECTION 22" RADIUS CURVED TRACK (4/card)	\$14.50
Item No. 44540	30 DEGREE CROSSING (1/card)	\$14.75
Item No. 44541	90 DEGREE CROSSING (1/card) Standard Pack: 6	\$18.00
Item No. 44542	60 DEGREE CROSSING (1/card) Standard Pack: 6	\$15.50
Item No. 44543	45 DEGREE CROSSING (1/card) Standard Pack: 6	\$15.00
Item No. 44557	#4 TURNOUT - LEFT (1/card) Standard Pack: 6	\$37.00
Item No. 44558	#4 TURNOUT - RIGHT (1/card) Standard Pack: 6	\$37.00
Item No. 44559	#6 TURNOUT - LEFT (1/card)	\$49.00
Item No. 44560	#6 TURNOUT - RIGHT (1/card)	\$49.00
Item No. 44561	REMOTE TURNOUT - LEFT (1/card)	\$24.00
Item No. 44562	REMOTE TURNOUT - RIGHT (1/card)	\$24.00
Item No. 44565	#5 TURNOUT - LEFT (1/card)	\$37.00
Item No. 44566	#5 TURNOUT - RIGHT (1/card)	\$37.00
Item No. 44569	#5 WYE TURNOUT (1/card)	\$37.00
Item No. 44575	#6 REMOTE CROSSOVER TURNOUT - LEFT (1/box)	\$69.00
Item No. 44576	#6 REMOTE CROSSOVER TURNOUT - RIGHT (1/box)	\$69.00
Item No. 44591	HAYES BUMPERS (2/card)	\$13.00
Item No. 44592	CONNECTOR TRACK ASSORTMENT (2 each .75", 1", 1.25", 1.5" and 2" straight pieces per card)	\$10.25
Item No. 44594	NICKEL SILVER E-Z TRACK® LAYOUT EXPANDER SET Standard Pack: 6	\$95.00
Item No. 44596	WORLD'S GREATEST HOBBY® TRACK PACK Standard Pack: 3	\$170.00
Item No. 44597	9" POWER TERMINAL with INSULATED GAP (2/card)	\$33.00

BULK NICKEL SILVER/GRAY ROADBED E-Z TRACK® (BY THE CARTON)		Standard Pack: 1
Item No. 44580	18" RADIUS CURVED TRACK - BULK (50 pieces per carton)	\$150.00
Item No. 44581	9" STRAIGHT TRACK - BULK (50 pieces per carton)	\$150.00
Item No. 44583	22" RADIUS CURVED TRACK - BULK (50 pieces per carton)	\$210.00
Item No. 44584	36" STRAIGHT TRACK - BULK (25 pieces per carton)	\$345.00

DECODER-EQUIPPED NICKEL SILVER E-Z TRACK® TURNOUTS		unless otherwise noted, Standard Pack: 4
Item No. 44130	E-Z COMMAND® DCC TURNOUT - LEFT (1/box)	\$46.00
Item No. 44131	E-Z COMMAND® DCC TURNOUT - RIGHT (1/box)	\$46.00
Item No. 44132	E-Z COMMAND® DCC #5 TURNOUT - LEFT (1/box)	\$56.00
Item No. 44133	E-Z COMMAND® DCC #5 TURNOUT - RIGHT (1/box)	\$56.00
Item No. 44134	E-Z COMMAND® DCC #5 WYE TURNOUT (1/box)	\$56.00
Item No. 44135	E-Z COMMAND® DCC #6 TURNOUT - LEFT (1/box)	\$69.00
Item No. 44136	E-Z COMMAND® DCC #6 TURNOUT - RIGHT (1/box)	\$69.00
Item No. 44137	E-Z COMMAND® DCC #6 SINGLE CROSSOVER TURNOUT - LEFT (1/box) Standard Pack: 2	\$79.00
Item No. 44138	E-Z COMMAND® DCC #6 SINGLE CROSSOVER TURNOUT - RIGHT (1/box) Standard Pack: 2	\$79.00
Item No. 44139	E-Z COMMAND® DCC #4 TURNOUT - LEFT (1/box)	\$55.00
Item No. 44140	E-Z COMMAND® DCC #4 TURNOUT - RIGHT (1/box)	\$55.00



ELECTRONIC AUTO-REVERSING NICKEL SILVER E-Z TRACK®		unless otherwise noted, Standard Pack: 12
Item No. 44547	NICKEL SILVER E-Z TRACK® REVERSING SYSTEM Standard Pack: 6	\$165.00
Item No. 44548	For auto-reversing sets only: 9" STRAIGHT TRACK (4/card)	\$34.00
Item No. 44549	For auto-reversing sets only: 18" RADIUS CURVED TRACK (4/card)	\$34.00

Bachmann's exclusive E-Z Track® System makes set-up quick, easy and fun! See Following Pages for Product Photographs

(shown in nickel silver/gray roadbed only for illustration purposes)

STEEL ALLOY/BLACK ROADBED E-Z TRACK® by the card		unless otherwise noted, Standard Pack: 12
Item No. 44401	18" RADIUS CURVED TRACK (4/card)	\$10.25
Item No. 44402	18" RADIUS CURVED TERMINAL RERAILER with WIRE (1/card)	\$9.25
Item No. 44403	22" RADIUS CURVED TRACK (4/card)	\$12.00
Item No. 44410	9" STRAIGHT TERMINAL RERAILER with WIRE (1/card)	\$9.25
Item No. 44411	9" STRAIGHT TRACK (4/card)	\$10.25
Item No. 44412	3" STRAIGHT TRACK (4/card)	\$6.75
Item No. 44428	9" STRAIGHT RERAILER (2/card)	\$5.75
Item No. 44429	18" RADIUS CURVED RERAILER (2/card)	\$5.75
Item No. 44440	30 DEGREE CROSSING (1/card)	\$8.00
Item No. 44441	90 DEGREE CROSSING (1/card) Standard Pack: 6	\$12.00
Item No. 44461	REMOTE TURNOUT - LEFT (1/card)	\$18.00
Item No. 44462	REMOTE TURNOUT - RIGHT (1/card)	\$18.00
Item No. 44491	HAYES BUMPERS (2/card)	\$12.50
Item No. 44493	TRACK ACCESSORY SET Standard Pack: 6	\$95.00
Item No. 44494	STEEL ALLOY E-Z TRACK® LAYOUT EXPANDER SET Standard Pack: 6	\$69.00
Item No. 44497	STEEL ALLOY WORLD'S GREATEST HOBBY® TRACK PACK Standard Pack: 3	\$125.00

BULK STEEL ALLOY/BLACK ROADBED E-Z TRACK® by the carton		Standard Pack: 1
Item No. 44480	18" RADIUS CURVED TRACK - BULK (50 pieces per carton)	\$90.00
Item No. 44481	9" STRAIGHT TRACK - BULK (50 pieces per carton)	\$90.00
Item No. 44483	22" RADIUS CURVED TRACK - BULK (50 pieces per carton)	\$135.00

ADDITIONAL ACCESSORY ITEMS		unless otherwise noted, Standard Pack: 12
Item No. 42901	HO/On30 E-Z RIDERS™ with BALL-BEARING ROLLERS (4 per pack)	\$66.00
Item No. 42902	HO/On30 E-Z RIDERS™ without ball-bearing rollers (4 per pack)	\$33.00
Item No. 42903	36" FLAT BACK WHEEL SETS (12 per card)	\$12.00
Item No. 42904	33" FLAT BACK WHEEL SETS (12 per card)	\$12.00
Item No. 44471	14-PIECE E-Z TRACK® GRADUATED PIER SET	\$22.50
Item No. 44472	8-PIECE E-Z TRACK® TALL PIER SET	\$18.50
Item No. 44498	10' POWER EXTENSION WIRE - RED (1/card)	\$9.25
Item No. 44499	RAIL JOINERS (36/card)	\$6.50
Item No. 44579	E-Z TRACK® CROSSING GATE Standard Pack: 6	\$40.00
Item No. 44595	18-PIECE E-Z TRACK® GRADUATED PIER SET (for higher HO elevation & On30 clearances)	\$30.25
Item No. 44598	10' REMOTE SWITCH EXTENSION WIRE - GREEN (1/card)	\$11.50
NEW Item No. 46299	MOTORIZED TURNTABLE Standard Pack: 2	\$140.00
Item No. 99978	E-Z MODEL RAILROADS TRACK PLANNING BOOK	\$24.00

PLUG-IN 10' POWER EXTENSION WIRE - RED
Item No. 44498 • (1/card)



PLUG-IN 10' REMOTE SWITCH EXTENSION WIRE - GREEN
Item No. 44598 • (1/card)



15" RADIUS CURVED TRACK
Item No. 44505 • (4/card)



4 pieces of track make up one third (120°) of a 15" radius circle.

ONE-THIRD SECTION 18" RADIUS CURVED TRACK
Item No. 44530 • (4/card)



HALF SECTION 18" RADIUS CURVED TRACK
Item No. 44531 • (4/card)



18" RADIUS CURVED TRACK
Item No. 44501 • (4/card)



4 pieces of track make up one third (120°) of an 18" radius circle.

18" RADIUS CURVED RERAILER
Item No. 44529 • (2/card)



18" RADIUS CURVED TERMINAL RERAILER with WIRE
Item No. 44502 • (1/card)



HALF SECTION 22" RADIUS CURVED TRACK
Item No. 44532 • (4/card)



22" RADIUS CURVED TRACK
Item No. 44503 • (4/card)



4 pieces of track make up one quarter (90°) of a 22" radius circle.

26" RADIUS CURVED TRACK
Item No. 44519 • (5/card)



5 pieces of track make up one quarter (90°) of a 26" radius circle.

28" RADIUS 18 DEGREE CURVED TRACK
Item No. 44506 • (5/card)



5 pieces of track make up one quarter (90°) of a 28" radius circle.

33.25" RADIUS 6 DEGREE CURVED TRACK
Item No. 44508 • (4/card)



33.25" RADIUS 12 DEGREE CURVED TRACK
Item No. 44509 • (4/card)



33.25" RADIUS 18 DEGREE CURVED TRACK
Item No. 44504 • (5/card)



5 pieces of track make up one quarter (90°) of a 33.25" radius circle.

35.50" RADIUS 18 DEGREE CURVED TRACK
Item No. 44507 • (5/card)



5 pieces of track make up one quarter (90°) of a 35.50" radius circle.

HO SCALE

SNAP-FIT E-Z TRACK®

CONNECTOR ASSORTMENT
Item No. 44592 • (10/card)



2 each .75",
1", 1.25",
1.5", and 2"
straight pieces
per card.

2.25" STRAIGHT TRACK
Item No. 44513 • (4/card)



3" STRAIGHT TRACK
Item No. 44512 • (4/card)



4.50" STRAIGHT TRACK
Item No. 44514 • (4/card)



9" STRAIGHT TRACK
Item No. 44511 • (4/card)



9" STRAIGHT RERAILER
Item No. 44528 • (2/card)



**9" STRAIGHT TERMINAL
RERAILER with WIRE**
Item No. 44510 • (1/card)



**9" POWER TERMINAL with
INSULATED GAP**
Item No. 44597 • (2/card)



*For under track
power connection
and reverse loop
operation.*

30 DEGREE CROSSING
Item No. 44540 • (1/card)



*This 30 Degree
Crossing is the
centerpiece of a
basic "Figure 8"
track
configuration.
To make a
Figure 8 you
also need: 21
pieces of 18"
Radius Curved
Track and 1
piece 18"
Radius Curved
Rerailer.*

45 DEGREE CROSSING
Item No. 44543 • (1/card)



60 DEGREE CROSSING
Item No. 44542 • (1/card)



90 DEGREE CROSSING
Item No. 44541 • (1/card)



*This 90 Degree
Crossing has
many useful
applications in
railroad design.
However, if your
goal is to make
a "Figure 8"
layout, you
should start
with a 30
Degree Crossing.*

#4 TURNOUT - LEFT
Item No. 44557 • (1/card)



#4 TURNOUT - RIGHT
Item No. 44558 • (1/card)



REMOTE TURNOUT - LEFT
Item No. 44561 • (1/card)



REMOTE TURNOUT - RIGHT
Item No. 44562 • (1/card)



#5 TURNOUT - LEFT
Item No. 44565 • (1/card)



#5 TURNOUT - RIGHT
Item No. 44566 • (1/card)



#5 WYE TURNOUT
Item No. 44569 • (1/card)



#6 TURNOUT - LEFT
Item No. 44559 • (1/card)



#6 TURNOUT - RIGHT
Item No. 44560 • (1/card)



#6 REMOTE CROSSOVER
TURNOUT - LEFT
Item No. 44575 • (1/box)



#6 REMOTE CROSSOVER
TURNOUT - RIGHT
Item No. 44576 • (1/box)



HAYES BUMPERS
Item No. 44591 • (2/card)



NICKEL SILVER E-Z TRACK® AUTO-REVERSING TRACK SYSTEM



Item No. 44547 • Standard Pack: 6 • \$165.00

Featuring our electronic auto-reversing *E-Z Track*®, this track set is the perfect solution for point-to-point passenger and freight transit on your layout. A stop time of five to seven seconds allows plenty of time to drop off your cargo or passengers, and a variable speed controller lets you determine the rate of travel. Add-on sections are also available (Item Nos. 44548 & 44549). Then, sit back and enjoy the ride while your town or city comes to life!

- 4 pieces of 9" straight auto-reversing *E-Z Track*®
- 4 pieces of 18" radius curved auto-reversing *E-Z Track*®
- 2 pieces of 9" straight *E-Z Track*®
- 2 Hayes bumpers
- power pack and variable speed controller
- illustrated instructions



ELECTRONIC AUTO-REVERSING NICKEL SILVER E-Z TRACK®

Standard Pack: 12 • \$34.00 each

You can expand your auto-reversing train set or track system with Electronic Auto-Reversing Nickel Silver *E-Z Track*® sections. Available in 9" straight or 18" radius curved sections, this electronically equipped track is specifically designed for the open-end track configuration of our auto-reversing track system, allowing you to go virtually anywhere in your layout.



AUTO-REVERSING 9" STRAIGHT
(4 per card)
Item No. 44548

Note: this track will not operate as reversing track unless it is used in conjunction with train set numbers 00401, 00402, 25016, 25017, or with our auto-reversing track system, Item No. 44547



AUTO-REVERSING 18" RADIUS CURVED
(4 per card)
Item No. 44549

WHEEL SETS

Standard Pack: 12 • \$12.00 each



36" FLAT BACK WHEEL SETS
(12 per card)
Item No. 42903



33" FLAT BACK WHEEL SETS
(12 per card)
Item No. 42904



RAIL JOINERS
(36 per card)
Item No. 44499 • Standard Pack: 12 • \$6.50

E-Z TRACK® PIER SETS

Standard Pack: 12



14-PIECE GRADUATED PIER SET
Item No. 44471 • \$22.50



8-PIECE TALL PIER SET
Item No. 44472 • \$18.50



18-PIECE GRADUATED PIER SET
(appropriate for higher HO elevations and On30 clearances)
Item No. 44595 • \$30.25

**HO/On30 E-Z RIDERS™
with BALL-BEARING ROLLERS (4 per pack)**

Item No. 42901 • Standard Pack: 12 • \$66.00

- for use with locomotive drivers
- full electrical pick-up



**HO/On30 E-Z RIDERS™
without ball-bearing rollers (4 per pack)**

Item No. 42902 • Standard Pack: 12 • \$33.00

- support roller for use with non-drive wheels
- full electrical pick-up



E-Z TRACK® CROSSING GATE

Item No. 44579 • Standard Pack: 6 • \$40.00



E-Z MODEL RAILROADS

The E-Z TRACK® Planning Guide & Layout Book

Item No. 99978 • Standard Pack: 12 • \$24.00

With *E-Z Model Railroads*, beginning and advanced modelers can learn how to set up and run a railroad using Bachmann's snap-fit *E-Z Track*® system. From choosing a layout style to wiring and track planning techniques, readers are walked through virtually every step of the design and construction process.

- six in-depth layouts, plus 20 additional layout designs
- tips for beginning to advanced modelers, including weathering and scenery chapters
- 124 color pages

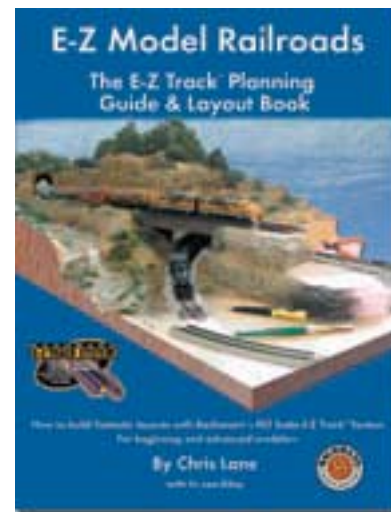

WORLD'S GREATEST HOBBY® FIRST RAILROAD TRACK PACK

Standard Pack: 3

It's never been easier to get started in model railroading! Our *World's Greatest Hobby*® *First Railroad Track Pack* contains all the track you need to build the 4' x 8' layout featured in the included DVD, *Building Your First Model Railroad*. Hosted by actor and model railroad enthusiast Michael Gross, the easy-to-follow video will quickly get you on track for fun with the World's Greatest Hobby!

45-piece World's Greatest Hobby® Your First Railroad Track Pack includes:

- World's Greatest Hobby *Building Your First Model Railroad* DVD, hosted by actor and model railroad enthusiast Michael Gross
- nine 9" straights
- one 9" terminal/rerailer
- one 9" rerailer
- twenty 18" radius curves
- two 3" straights
- two remote turnouts - left
- two remote turnouts - right
- two Hayes bumpers
- four switch wires (green)
- one terminal wire (red)

Bachmann HO scale E-Z Track® features:

- clear tie spacing
- low-profile spike heads
- modeled from AAR track engineering dimensions



with STEEL ALLOY HO SCALE E-Z TRACK®
Item No. 44497 • \$125.00



with NICKEL SILVER HO SCALE E-Z TRACK®
Item No. 44596 • \$170.00

STEEL ALLOY E-Z TRACK® ACCESSORY SET

Standard Pack: 6

Railroading fun gets bigger and better with our *E-Z Track® Accessory Set!* Turn a basic 36" circle into a giant over-under "figure 8" layout with a 14-piece graduated pier set and 14 pieces of steel alloy *E-Z Track®*. A motorized Gandy Dancer hand car and assembled lighted station complete the scene, while an illustrated track plan booklet offers additional layout ideas. For use with Bachmann's steel alloy *E-Z Track®*.

Features include:

- 14-piece graduated pier set
- 8 pieces of 18" radius curved steel alloy *E-Z Track®*
- 6 pieces of 9" straight steel alloy *E-Z Track®*
- motorized Gandy Dancer hand car
- assembled lighted station
- illustrated track plan booklet



STEEL ALLOY E-Z TRACK® ACCESSORY SET
Item No. 44493 • \$95.00

E-Z TRACK® LAYOUT EXPANDER SETS

Standard Pack: 6

With the *E-Z Track® Expander Set*, you can add to the track included with our train sets or create new configurations of turnouts, branchlines, and double-track mainlines on your existing railroad. Also, a handy track plan manual included with the *Expander Set* contains ideas to inspire railroad tycoons of all ages. Offered in steel alloy (with black roadbed) or nickel silver (with gray roadbed) versions.

Features include:

- 12 pieces of snap-fit *E-Z Track®*, including 4 pieces of 9" straight, 4 pieces 18" radius curved track, 1 remote turnout - left, 1 remote turnout - right, and 2 Hayes bumpers
- quick, easy assembly on floors, tables, and carpets without the need for special tools or fasteners
- helpful track plan manual



STEEL ALLOY
Item No. 44494 • \$69.00



NICKEL SILVER
Item No. 44594 • \$95.00

N

SCALE

ELECTRIC TRAIN SETS

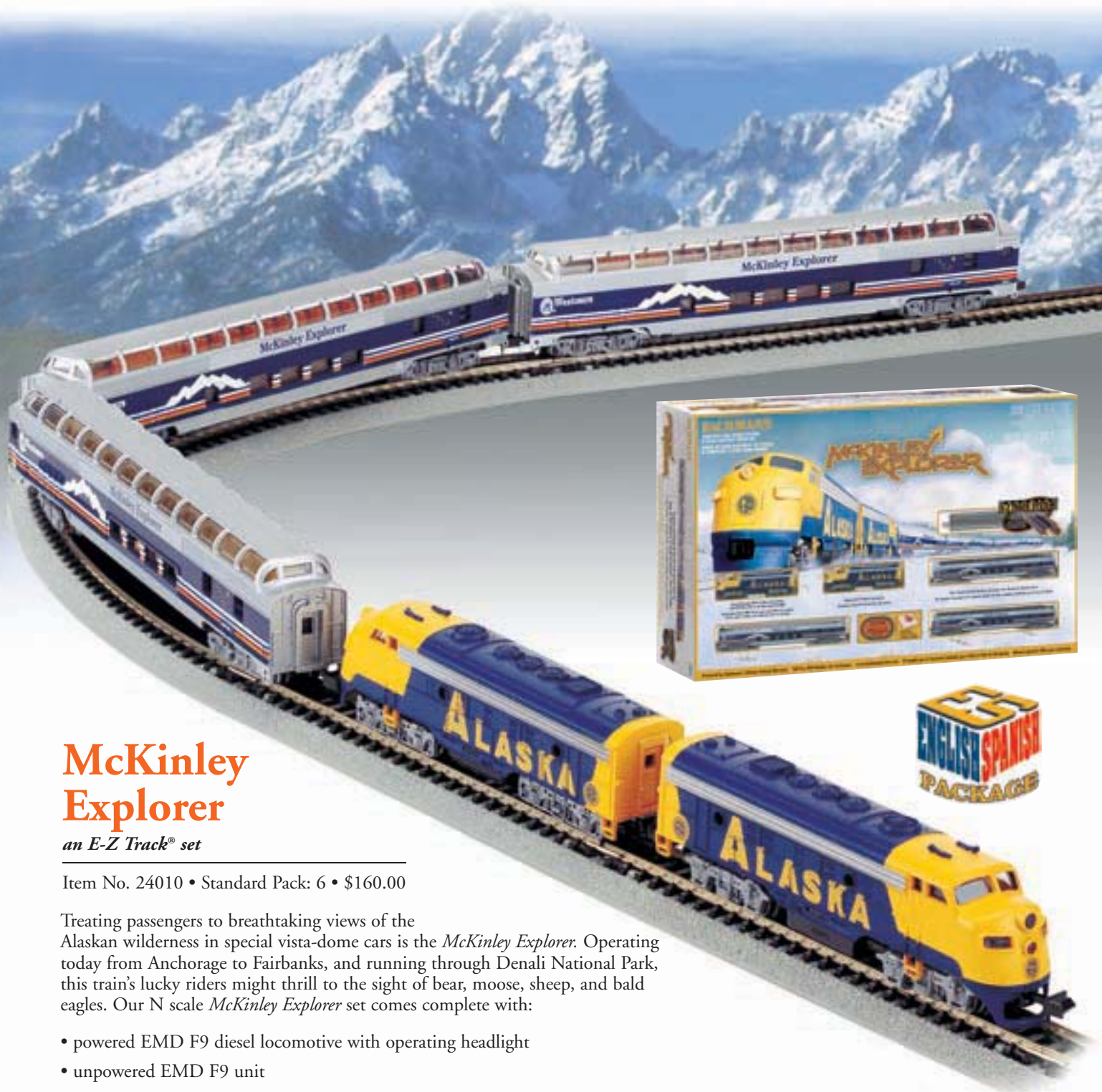

McKinley Explorer

an E-Z Track® set

Item No. 24010 • Standard Pack: 6 • \$160.00

Treating passengers to breathtaking views of the Alaskan wilderness in special vista-dome cars is the *McKinley Explorer*. Operating today from Anchorage to Fairbanks, and running through Denali National Park, this train's lucky riders might thrill to the sight of bear, moose, sheep, and bald eagles. Our N scale *McKinley Explorer* set comes complete with:

- powered EMD F9 diesel locomotive with operating headlight
- unpowered EMD F9 unit
- three full-dome passenger cars (the *Kenai*, *Knik* and *Deshka*, all named after Alaskan rivers)
- 34" x 24" oval of nickel silver E-Z Track® including 11 pieces curved track, 4 pieces straight track, and 1 curved plug-in terminal railer
- power pack and speed controller
- illustrated instruction manual



ELECTRIC TRAIN SETS

Spirit of Christmas

an E-Z Track® set

Item No. 24017 • Standard Pack: 6 • \$175.00

Good things come in small packages. This is certainly true when it comes to the *Spirit of Christmas* N scale set. Perfect for under-the-tree in a small space and festively decorated for a very Merry Christmas, this ready-to-run set features:

- 0-6-0 steam locomotive and tender
- old-time combine
- two old-time coaches
- 34" x 24" oval of nickel silver E-Z Track® including 11 pieces curved track, 4 pieces straight track, and 1 curved plug-in terminal rerailer
- power pack and speed controller
- illustrated instruction manual



Highballer

an E-Z Track® set

Item No. 24002 • Standard Pack: 6 • \$115.00

The term "highball" originally referred to a railroad track signal indicating it was safe to proceed (literally, a ball hung over the track). In time, the expression "highballer" evolved to describe a train engineer who ran his locomotives at reckless speeds. We urge you to go easy on the throttle when you operate this *Highballer* train set! *The Highballer* comes complete with Bachmann's exclusive E-Z Track® snap-fit track and roadbed system, plus:

- smooth-running EMD F9 diesel locomotive with all-wheel drive and operating headlight
- box car
- gondola
- off-center caboose
- 24" circle of nickel silver E-Z Track®, including 11 pieces curved track and 1 curved plug-in terminal rerailer
- power pack and speed controller
- illustrated instruction manual



Thunder Valley

an E-Z Track® set

Item No. 24013 • Standard Pack: 6
\$115.00

The rails rumble and the engine roars as the mighty *Thunder Valley* rounds the bend, hauling freight to destinations far and wide. This train set comes complete with Bachmann's

exclusive E-Z Track® snap-fit track and roadbed systems, plus:

- an EMD GP40 diesel locomotive with operating headlight
- steel reefer
- three-dome tank car
- wide-vision caboose
- 24" circle of nickel silver E-Z Track®, including 11 pieces curved track and 1 curved plug-in terminal rerailer

- power pack and speed controller
- illustrated instruction manual



Royal Blue

an E-Z Track® set

Item No. 24018 • Standard Pack: 6
\$175.00

The *Royal Blue* is truly majestic. This classic train treated the prominent and powerful to first-class service between New York City and Washington, DC at the turn of the last century. Beautiful in

its distinctive cobalt blue, silver, and gold paint scheme, this train is a must for collectors. The *Royal Blue* ready-to-run starter set features:

- an American 4-4-0 steam locomotive and tender
- old-time combine
- two old-time coaches
- 34" x 24" oval of nickel silver E-Z Track® including 11 pieces curved track, 4 pieces straight track, and 1 curved plug-in terminal rerailer

- power pack and speed controller
- illustrated instruction manual



Southern Belle

an E-Z Track® set

Item No. 24019 • Standard Pack: 6
\$175.00

The *Southern Belle* races across the rails against the gleam of the Dixie skies on her way to the next depot. Making sure the freight is delivered on time, this exciting ready-to-run set features:

- an 0-6-0 steam locomotive and tender
- three-dome tank car
- gondola
- boxcar
- off-center caboose
- 34" x 24" oval of nickel silver E-Z Track® including 11 pieces curved track, 4 pieces straight track, and 1 curved plug-in terminal rerailer
- 12 telephone poles
- 24 railroad and street signs
- power pack and speed controller

- illustrated instruction manual



The Frontiersman

an E-Z Track® set

Item No. 24006 • Standard Pack: 6
\$180.00

The early railroads were instrumental in opening vast tracts of American land for settlement and development. Moving people, natural resources, and supplies, steam trains could rightfully be called "Frontiersmen."

Our *Frontiersman* train set comes complete with Bachmann's exclusive E-Z Track® snap-fit track and roadbed system, plus:

- an American 4-4-0 steam locomotive and tender
- old-time water tank car
- old-time box car
- old-time gondola
- old-time flat car
- old-time bobber caboose
- 34" x 24" oval of nickel silver E-Z Track® including 11 pieces curved track, 4 pieces straight track, and 1 curved plug-in terminal rerailer

- power pack and speed controller
- illustrated instruction manual



ELECTRIC TRAIN SETS

24" Circle

4 TRACK SYSTEM

Speed Controller with Plug-In Wiring



34" x 24" Oval

4 TRACK SYSTEM

Speed Controller with Plug-In Wiring



34" x 24" Oval

4 TRACK SYSTEM

Speed Controller with Plug-In Wiring

12 Telephone Poles

24 Railroad & Street Signs



34" x 24" Oval

4 TRACK SYSTEM

Speed Controller with Plug-In Wiring

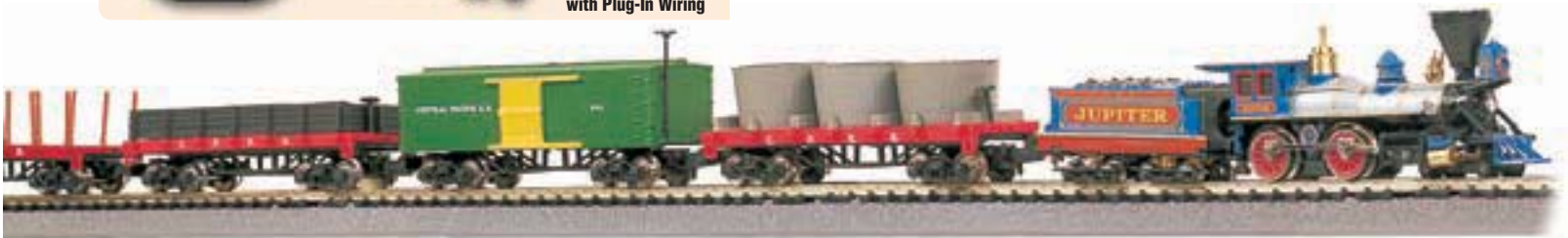

Explorer

an E-Z Track® set

Item No. 24008 • Standard Pack: 6
\$165.00

As a freight train makes its way over the rails, it's a modern explorer of an ever-changing landscape. Each day brings new adventures and new excitement! This *Explorer* train set comes complete with Bachmann's exclusive E-Z Track® snap-fit track and roadbed system, plus:

- a powered EMD F9 diesel locomotive with operating headlight
- unpowered "A" unit F9 diesel locomotive
- single-dome tank car
- refrigerator car
- covered hopper
- plug-door box car
- flat car with containers
- off-center caboose
- 34" x 24" oval of nickel silver E-Z Track® including 11 pieces curved track, 4 pieces straight track, and 1 curved plug-in terminal railer
- 12 telephone poles
- 24 railroad and street signs
- power pack and speed controller
- illustrated instruction manual



Empire Builder

an E-Z Track® set

Item No. 24009 • Standard Pack: 6
\$250.00

American railroads helped build great fortunes and the wealth of the Nation. Doing its part, our *Empire Builder* train set comes complete with Bachmann's exclusive E-Z Track® snap-fit track and roadbed system, plus:

- a Northern 4-8-4 steam locomotive and tender with operating headlight
- wood reefer
- single-dome tank car
- center-flow hopper
- plug-door box car
- wood stock car
- wood braced gondola
- open quad offset hopper
- off-center caboose
- 44" x 24" oval of nickel silver E-Z Track® including 11 pieces curved track, 8 pieces straight track, and 1 curved plug-in terminal railer
- 12 telephone poles
- 24 railroad and street signs
- power pack and speed controller
- illustrated instruction manual



The Yard Boss

an E-Z Track® set

Item No. 24014 • Standard Pack: 6 • \$155.00

When there's freight to be moved, there's nothing like the raw power of a steam locomotive to get the job done. Our *Yard Boss* train set comes complete with Bachmann's exclusive E-Z Track® snap-fit track and roadbed system, plus:

- an 0-6-0 steam locomotive and tender
- box car
- quad hopper
- wide-vision caboose
- 24" circle of nickel silver E-Z Track® including 11 pieces curved track and 1 curved plug-in terminal railer
- power pack and speed controller
- illustrated instruction manual



ELECTRIC TRAIN SETS

N
SCALE



34" x 24" Oval

3-TRACK SYSTEM

Speed Controller with Plug-In Wiring

12 Telephone Poles

24 Railroad & Street Signs



44" x 24" Oval

3-TRACK SYSTEM

Speed Controller with Plug-In Wiring

12 Telephone Poles

24 Railroad & Street Signs



24" Circle

3-TRACK SYSTEM

Speed Controller with Plug-In Wiring



N

SCALE

STEAM LOCOMOTIVES

BALDWIN 4-6-0 STEAM LOCOMOTIVE

Standard Pack: 6 • \$165.00 each

Adding another axle to the 4-4-0 design gave the Ten-Wheeler extra tractive power to haul heavy loads up mountainous terrain, making it a great all-around train for freight and passenger service. This DCC-equipped 4-6-0 with 63" drivers is ready to make the grade in N scale.

Features include:

- DCC-equipped for speed, direction, and lighting
- dual-mode NMRA-compliant decoder
- precision can motor
- die-cast boiler and chassis
- separate domes and stack
- finescale detailing including bell, whistle, and piping
- gear drive
- Walschaert valve gear
- blackened metal wheels
- high-quality traction tires
- detailed backhead
- NMRA wheel profile
- E-Z Mate® Mark II couplers



PAINTED, UNLETTERED - BLACK
Item No. 51451



PAINTED, UNLETTERED - BLACK with
RED WINDOWS and WHITE STRIPES
Item No. 51452



NEW YORK CENTRAL® #1235
Item No. 51453



UNION PACIFIC® #1590
Item No. 51454



SOUTHERN #1006
Item No. 51455



CHICAGO NORTHWESTERN #237
Item No. 51456

NORTHERN 4-8-4 & HICKEN OIL TENDER with OPERATING HEADLIGHT

Performs best on 11.25" radius curves or greater.

Standard Pack: 6 • \$137.00 each

GREAT NORTHERN
Item No. 58161

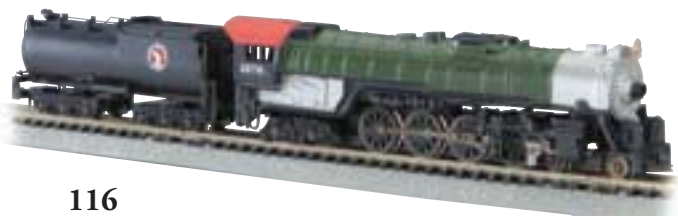

DCC ON BOARD™

STEAM LOCOMOTIVES

N SCALE

NORTHERN 4-8-4 & 52' TENDER with OPERATING HEADLIGHT

Performs best on 11.25" radius curves or greater.

Standard Pack: 6 • \$137.00 each



SANTA FE #3783
Item No. 58152



ROCK ISLAND #5113
Item No. 58158



PRAIRIE 2-6-2 & TENDER

Performs best on 11.25" radius curves or greater.

Standard Pack: 12 • \$88.00 each



UNION PACIFIC® #1836
Item No. 51551



SOUTHERN
Item No. 51554

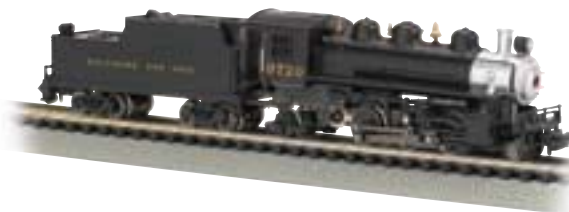

BALTIMORE & OHIO®
Item No. 51562



NEW YORK CENTRAL® #1905
Item No. 51570



DENVER & RIO GRANDE WESTERN™
(Flying Grande)
Item No. 51589



**PAINTED, UNLETTERED - BLACK with RED WINDOWS
and WHITE STRIPES**
Item No. 51598

N SCALE

STEAM LOCOMOTIVES

USRA 0-6-0 SWITCHER & TENDER

Performs best on 11.25" radius curves or greater.

Standard Pack: 12 • \$68.00 each



UNION PACIFIC®
Item No. 50551



SANTA FE #3283
Item No. 50552



NEW

BALTIMORE & OHIO® #338
(not shown)
Item No. 50562



PENNSYLVANIA
Item No. 50564



NEW YORK CENTRAL®
Item No. 50570

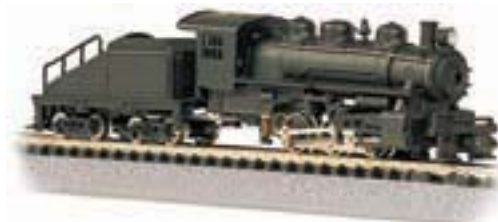

PAINTED, UNLETTERED - BLACK
Item No. 50598

4-4-0 AMERICAN & TENDER

Performs best on 11.25" radius curves or greater.

Standard Pack: 12 • \$88.00 each



BALTIMORE & OHIO®
Item No. 11751



PENNSYLVANIA
Item No. 11753



BALTIMORE & OHIO® - ROYAL BLUE
Item No. 11754

NEW

GREAT NORTHERN #124
(not shown)
Item No. 11755



UNION PACIFIC® #119
Item No. 51151



CENTRAL PACIFIC "JUPITER"
Item No. 51174

EMD DD40AX CENTENNIAL (DCC EQUIPPED)

Performs best on 11.25" radius curves or greater.

Standard Pack: 6 • \$125.00 each

DCC ON BOARD™ locomotives feature dual-mode digital command control decoders enabling operation with a standard DC analog power pack or any NMRA-compliant Digital Command Control system. Speed, direction, and lighting control. *E-Z Mate® II* couplers included.



UNION PACIFIC® #6900
Item No. 62255

UNION PACIFIC® #6910
(not shown)
Item No. 62256

UNION PACIFIC® #6919
(not shown)
Item No. 62257

UNION PACIFIC® #6942
(not shown)
Item No. 62258

EMD GP7 DIESEL LOCOMOTIVE (DCC EQUIPPED)

Performs best on 11.25" radius curves or greater.

Standard Pack: 6 • \$109.00 each

The first General Purpose locomotive, introduced in 1949, the GP7 had the distinctive design and low-cost maintenance features that made EMD's "Geeps" so popular and helped ensure diesel's dominance of the railroads. Bachmann's model includes advanced features such as an NMRA-compliant DCC decoder, LED lighting, and finescale detailing—all now fitted to N scale.

Features include:

- DCC-equipped for speed, direction, and lighting
- dual-mode NMRA-compliant decoder
- all-wheel drive
- can motor
- super-quiet drive train
- die-cast chassis
- finescale handrails
- blackened metal wheels
- directional lighting
- NMRA wheel profile
- *E-Z Mate®* Mark II couplers



PENNSYLVANIA #8542
Item No. 62451



UNION PACIFIC® #116
(with dynamic brakes)
Item No. 62452



CHESSIE #6411
Item No. 62453



BALTIMORE & OHIO® #6414
Item No. 62454



NEW YORK CENTRAL® #5608
Item No. 62455



CLINCHFIELD #908
(with dynamic brakes)
Item No. 62456

N SCALE

DIESEL LOCOMOTIVES

EMD GP50 with OPERATING DIRECTIONAL HEADLIGHTS

Performs best on 11.25" radius curves or greater.

Standard Pack: 12 • \$46.00 each



UNION PACIFIC®
Item No. 61251



SANTA FE
Item No. 61252



SOUTHERN
Item No. 61254



NORFOLK SOUTHERN
Item No. 61291

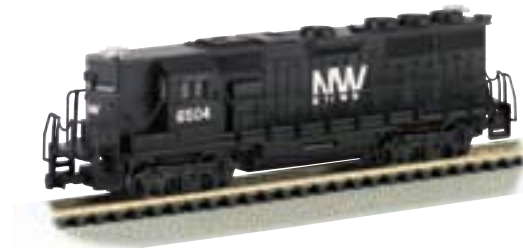

NORFOLK & WESTERN
Item No. 61292



WISCONSIN CENTRAL
(not shown)
Item No. 61297

EMD GP40 with OPERATING DIRECTIONAL HEADLIGHTS

Performs best on 11.25" radius curves or greater.

Standard Pack: 12 • \$46.00 each



UNION PACIFIC®
Item No. 63551



SANTA FE
Item No. 63552



CONRAIL
Item No. 63556



CHESSIE® SYSTEM
Item No. 63559



WESTERN MARYLAND®
Item No. 63587



ALASKA
Item No. 63598

DIESEL LOCOMOTIVES

U36-B with OPERATING DIRECTIONAL HEADLIGHTS
Performs best on 11.25" radius curves or greater.

Standard Pack: 12 • \$46.00 each



SANTA FE
Item No. 64052



BURLINGTON NORTHERN
Item No. 64053



CSX®
Item No. 64068

MDT PLYMOUTH
Performs best on 11.25" radius curves or greater.

Standard Pack: 12 • \$45.00 each



SANTA FE #32
Item No. 60052



BURLINGTON #9280
Item No. 60066



INDUSTRIAL - YELLOW
Item No. 60089



INDUSTRIAL - RED
Item No. 60090

PCC STREETCAR

Performs best on 11.25" radius curves or greater.

Standard Pack: 12 • \$46.00 each



CINCINNATI
Item No. 62991



KANSAS CITY
Item No. 62992

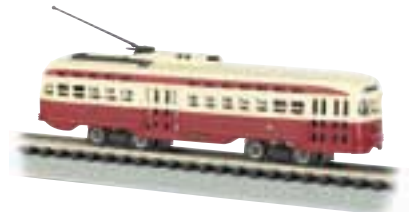

TORONTO TRANSIT
Item No. 62993



ST. LOUIS RAILWAYS
Item No. 62994



PTC
Item No. 62995

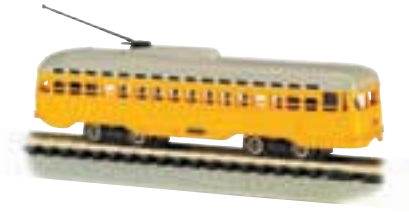

YELLOW
Item No. 62998

BRILL TROLLEY

Performs best on 11.25" radius curves or greater.

Standard Pack: 12 • \$46.00 each



CHRISTMAS
Item No. 61085



DESIRE
Item No. 61086



MAIN STREET
Item No. 61090

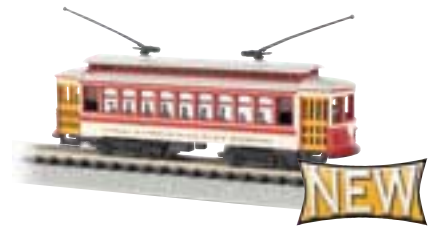

NEW YORK 3RD AVENUE
Item No. 61092



GREEN
Item No. 61093



YELLOW #36
Item No. 61098

85' BUDD AMTRAK PASSENGER CAR with LIGHTED INTERIOR

Standard Pack: 12 • \$43.00 each



AMFLEET I PHASE II CAFÉ
Item No. 14160



AMFLEET I PHASE III CAFÉ
Item No. 14161



AMFLEET I PHASE IV CAFÉ
Item No. 14162



AMFLEET I PHASE IV B COACH
Item No. 14164



AMFLEET I ACELA® REGIONAL CAFÉ
Item No. 14163

85' FULL-DOME PASSENGER CAR

Standard Pack: 12 • \$18.75 each



SANTA FE
Item No. 74352



AMTRAK
Item No. 74355

JACKSON SHARP OPEN-SIDED EXCURSION CARS

Standard Pack: 12 • \$28.50 each



**PAINTED, UNLETTERED
GREEN & RED**
Item No. 19396

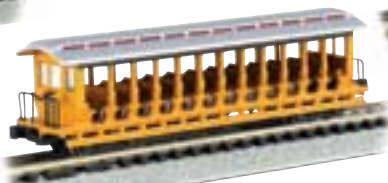

**PAINTED, UNLETTERED
YELLOW & SILVER**
Item No. 19398



**PAINTED, UNLETTERED
BURGUNDY & BLACK**
Item No. 19397

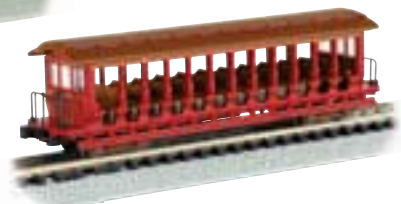

**PAINTED, UNLETTERED
RED & BROWN**
Item No. 19399

CANADIAN 4-BAY CYLINDRICAL GRAIN HOPPER

Standard Pack: 12 • \$16.50 each

Features include:

- blackened metal wheels
- E-Z Mate® Mark II magnetically operated knuckle couplers



SANTA FE
Item No. 19152



CANADIAN NATIONAL
Item No. 19163



CP RAIL
Item No. 19177



CANADA GRAIN
Item No. 19181



GOVERNMENT OF CANADA
Item No. 19184



HERITAGE FUND
Item No. 19189

56' CENTER-FLOW HOPPER

Standard Pack: 12 • \$13.25 each



SANTA FE
Item No. 70552



ROCK ISLAND
Item No. 70558



NEW YORK CENTRAL®
Item No. 70570



LEHIGH VALLEY
Item No. 70577



ERIE LACKAWANNA
Item No. 70578

PS2 COVERED HOPPER

Standard Pack: 12 • \$13.25 each



KOPPERS PLASTICS
Item No. 73893



WABASH
Item No. 73897

40' BOX CAR

Standard Pack: 12 • \$13.25 each



READING "BEE LINE"
Item No. 70060



NEW YORK CENTRAL®
Item No. 70070



RUTLAND
Item No. 70079



ALTON & SOUTHERN
Item No. 70084



WESTERN MARYLAND®
Item No. 70087



DENVER & RIO GRANDE WESTERN™
Item No. 70089

50' PLUG-DOOR BOX CAR

Standard Pack: 12 • \$13.25 each



CHESSIE® SYSTEM
Item No. 71059



MILWAUKEE ROAD
Item No. 71067



FRISCO
Item No. 71075



ERIE LACKAWANNA
Item No. 71078

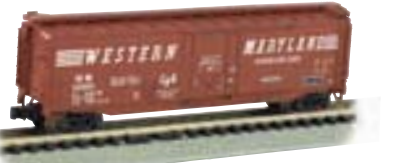

WESTERN MARYLAND®
Item No. 71087

50' STEEL REEFER

Standard Pack: 12 • \$13.25 each



UNION PACIFIC®
Item No. 70951



SANTA FE
Item No. 70952



CANADIAN NATIONAL
Item No. 70963



TROPICANA
Item No. 70997



PACIFIC FRUIT EXPRESS™
Item No. 70998

FLAT CAR with LOAD

Standard Pack: 12 • \$16.50 each

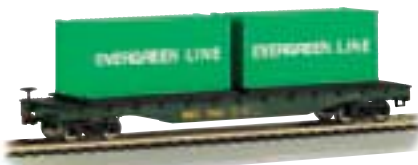

MAINE CENTRAL with CONTAINER LOAD
Item No. 18951



MAINE CENTRAL with CRATED LOAD
Item No. 18952

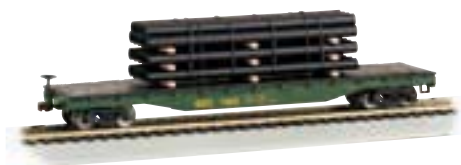

MAINE CENTRAL with PIPE LOAD
Item No. 18953



MAINE CENTRAL with STEEL LOAD
Item No. 18954



**PENNSYLVANIA RAILROAD
with CONTAINER LOAD**
Item No. 18956



**PENNSYLVANIA RAILROAD
with CRATED LOAD**
Item No. 18957

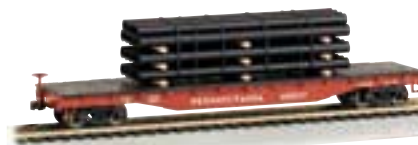

**PENNSYLVANIA RAILROAD
with PIPE LOAD**
Item No. 18958



**PENNSYLVANIA RAILROAD
with STEEL LOAD**
Item No. 18959



SANTA FE with CONTAINER LOAD
Item No. 18961



SANTA FE with CRATED LOAD
Item No. 18962



SANTA FE with PIPE LOAD
Item No. 18963



SANTA FE with STEEL LOAD
Item No. 18964



SEABOARD® with CONTAINER LOAD
Item No. 18966



SEABOARD® with CRATED LOAD
Item No. 18967

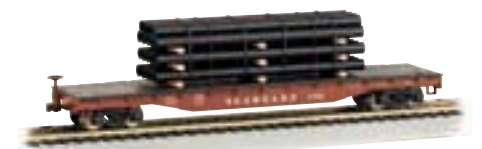

SEABOARD® with PIPE LOAD
Item No. 18968



SEABOARD® with STEEL LOAD
Item No. 18969

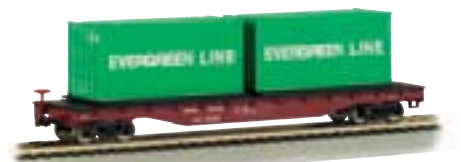

UNION PACIFIC® with CONTAINER LOAD
Item No. 18971



UNION PACIFIC® with CRATED LOAD
Item No. 18972

Some HO scale versions of our N scale *Silver Series*® rolling stock are shown on these pages for illustration purposes.

FLAT CAR with LOAD (continued)

Standard Pack: 12 • \$16.50 each

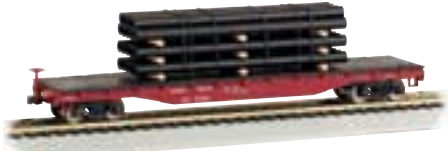

UNION PACIFIC® with PIPE LOAD
Item No. 18973

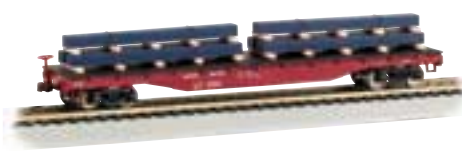

UNION PACIFIC® with STEEL LOAD
Item No. 18974



WESTERN MARYLAND® with CONTAINER LOAD
Item No. 18976



WESTERN MARYLAND® with CRATED LOAD
Item No. 18977

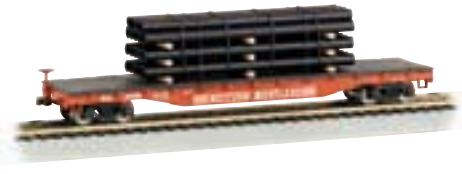

WESTERN MARYLAND® with PIPE LOAD
Item No. 18978



WESTERN MARYLAND® with STEEL LOAD
Item No. 18979

ACF 40' LOG CAR

Standard Pack: 12 • \$22.00 each

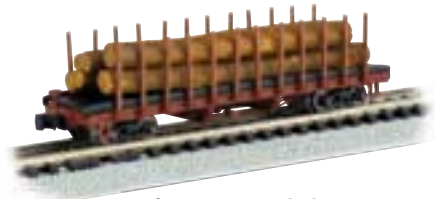

1906 - 1935 VERSION
Item No. 18351



1935 - 1960 VERSION
Item No. 18352

40' QUAD HOPPER

Standard Pack: 12 • \$13.25 each



READING
Item No. 73360



CSX®
Item No. 73368



CHESAPEAKE & OHIO®
Item No. 73372



SEABOARD®
Item No. 73390



NORFOLK & WESTERN
Item No. 73392



MINNEAPOLIS & ST. LOUIS
Item No. 73396

40' THREE-DOME TANK CAR

Standard Pack: 12 • \$13.25 each



SHELL
Item No. 70184



QUAKER STATE
Item No. 70187

40' GONDOLA

Standard Pack: 12 • \$13.25 each

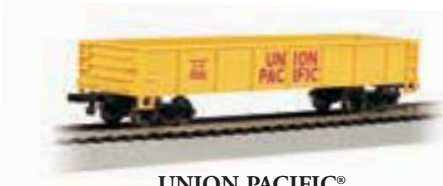

UNION PACIFIC®
Item No. 73651



SOUTHERN
Item No. 73654



BURLINGTON
Item No. 73666



WABASH
Item No. 73697

40' SINGLE-DOME TANK CAR

Standard Pack: 12 • \$13.25 each



MAGNOLIA
Item No. 73481



SHELL
Item No. 73484



PENNSALT
Item No. 73486



QUAKER STATE
Item No. 73487



PHILLIPS 66
Item No. 73490



TAGOLENE
Item No. 73493

HI-CUBE BOX CAR

Standard Pack: 12 • \$13.25 each



UNION PACIFIC®
Item No. 71251



BURLINGTON
Item No. 71266



DENVER & RIO GRANDE WESTERN™
Item No. 71289

40' STOCK CAR

Standard Pack: 12 • \$13.25 each



UNION PACIFIC®
Item No. 71551



BALTIMORE & OHIO®
Item No. 71562

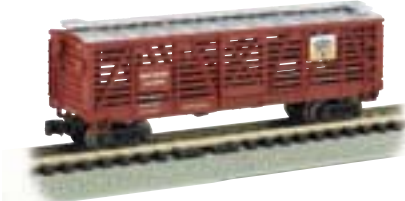

NORTHERN PACIFIC
Item No. 71584

ROLLING STOCK

52' CENTER-DEPRESSED FLAT CAR

Standard Pack: 12



with MISSILE
Item No. 71391 • \$20.00



with BOILER
Item No. 71395 • \$18.00



OLIVE DRAB MILITARY with MISSILE
Item No. 71396 • \$20.00



DESERT MILITARY with MISSILE
Item No. 71397 • \$20.00



with TRANSFORMER
Item No. 71398 • \$16.50



with NO LOAD
Item No. 71399 • \$15.00

TRI-LEVEL/CRANE & BOOM

Standard Pack: 12



89' TRI-LEVEL with AUTOS
SANTA FE
Item No. 46502 • \$22.00



250-TON CRANE & BOOM
UNION PACIFIC®
Item No. 46611 • \$25.00



250-TON CRANE & BOOM
PAINTED, UNLETTERED
Item No. 46698 • \$25.00



250-TON CRANE & BOOM
SANTA FE
Item No. 46612 • \$25.00

36' WIDE-VISION CABOOSE

Standard Pack: 12 • \$13.25 each



UNION PACIFIC®
Item No. 70751



SANTA FE
Item No. 70752



BURLINGTON NORTHERN
Item No. 70753



CSX®
Item No. 70768



NORFOLK & WESTERN
Item No. 70792

Some HO scale versions of our N scale Silver Series® rolling stock are shown on these pages for illustration purposes.

N SCALE

PLASTICVILLE® U.S.A. BUILT-UPS



Instant buildings for your railroad! The already-assembled models shown on these pages will add interest and realism to any N scale layout.

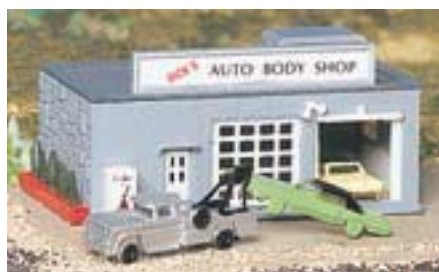

AUTO BODY SHOP

Item No. 45708 • Standard Pack: 12 • \$15.00



DRIVE-IN BURGER STAND

Item No. 45709 • Standard Pack: 12 • \$15.00



DRIVE-IN BANK

Item No. 45804 • Standard Pack: 12 • \$15.00



**SCHOOL HOUSE with
PLAYGROUND EQUIPMENT**

Item No. 45807 • Standard Pack: 12 • \$15.00



FARM HOUSE

Item No. 45812 • Standard Pack: 12 • \$15.00



TWO-STORY HOUSE

Item No. 45813 • Standard Pack: 12 • \$15.00



NEW ENGLAND RANCH HOUSE

Item No. 45814 • Standard Pack: 12 • \$15.00



FACTORY

Item No. 45902 • Standard Pack: 12 • \$16.50



CAR SHOWROOM

Item No. 45903 • Standard Pack: 12 • \$16.50



GAS STATION

Item No. 45904 • Standard Pack: 12 • \$16.50



PLATFORM STATION

Item No. 45906 • Standard Pack: 12 • \$16.50



FREIGHT STATION

Item No. 45907 • Standard Pack: 12 • \$16.50

PLASTICVILLE® U.S.A.
BUILT-UPS AND ACCESSORIES

N
SCALE



PASSENGER STATION
 Item No. 45908 • Standard Pack: 12 • \$16.50



CONTEMPORARY HOUSE
 Item No. 45909 • Standard Pack: 12 • \$16.50



WATER TANK
 Item No. 45810 • Standard Pack: 12 • \$15.00



COUNTRY CHURCH
 Item No. 45815 • Standard Pack: 12 • \$15.00



COALING STATION
 Item No. 45811 • Standard Pack: 12 • \$15.00



ELECTRIC DIESEL HORN in OIL TANK
 Item No. 46901 • Standard Pack: 12 • \$34.00



STEAM WHISTLE in FREIGHT STATION
 Item No. 46902 • Standard Pack: 12 • \$36.00



BLINKING OIL TANK
 Item No. 46903 • Standard Pack: 12 • \$21.00



BLINKING BRIDGE
 Item No. 46904 • Standard Pack: 12 • \$18.75

NEW



BRIDGE
 Item No. 46905 • Standard Pack: 12 • \$16.50



Have a question? You can
 "Ask the Bach-Man" on
 our message board at
www.bachmanntrains.com!



FIGURE SET
Item No. 42502 • Standard Pack: 24 • \$8.00



CROSSING GATES and SIGNALS
(12 pieces)
Item No. 42504 • Standard Pack: 24 • \$8.00



ANIMAL SET
Item No. 42505 • Standard Pack: 24 • \$8.00

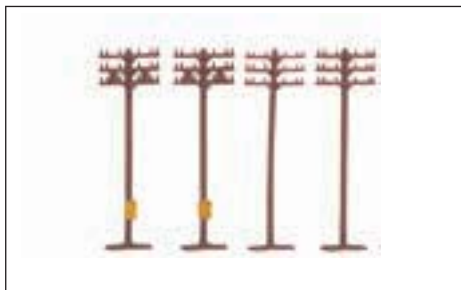

TELEPHONE POLES
(12 pieces)
Item No. 42506 • Standard Pack: 24 • \$8.00



RAILROAD and STREET SIGNS
(24 pieces)
Item No. 42513 • Standard Pack: 24 • \$8.00



ROAD CROSSING
Item No. 42522 • Standard Pack: 24 • \$8.00

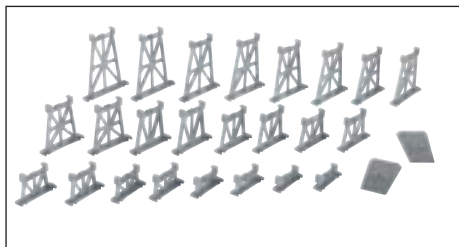

26-PIECE GRADUATED TRESTLE SET
(not compatible with E-Z Track®)
Item No. 42523 • Standard Pack: 12 • \$17.50



DUAL CROSSING GATES
Item No. 46720 • Standard Pack: 12 • \$11.00

DUMMY KNUCKLE COUPLERS (non-operating)

Standard Pack: 12



DUMMY KNUCKLE COUPLERS - VARIETY PACK
12 sets of 3 coupler pairs per card
(1 set of 3 coupler pairs shown)
Item No. 42531 • \$28.00 each card
A set of three coupler pairs contains one pair each appropriate for rolling stock, standard line locomotives and Spectrum® locomotives.



DUMMY KNUCKLE COUPLER TRUCK ASSEMBLY
(without wheels)
12 truck pairs per card
Item No. 42533 • \$28.00 each card

NEW

FRICTION BEARING FREIGHT TRUCKS
(without wheels; not shown)
12 truck pairs per card
Item No. 42534 • price to be announced

NEW

ROLLER BEARING FREIGHT TRUCKS
(without wheels; not shown)
12 truck pairs per card
Item No. 42535 • price to be announced

E-Z TRACK® CROSSING GATE

Item No. 44879 • Standard Pack: 6 • \$35.75



MAGNETICALLY OPERATED E-Z MATE® MARK II COUPLERS – LONG

(not shown)

12 coupler pairs per card

Item No. 78501 • Standard Pack: 12 cards • \$23.00



MAGNETICALLY OPERATED E-Z MATE® MARK II COUPLERS – MEDIUM

(not shown)

12 coupler pairs per card

Item No. 78502 • Standard Pack: 12 cards • \$23.00



MAGNETICALLY OPERATED E-Z MATE® MARK II COUPLERS – SHORT

(not shown)

12 coupler pairs per card

Item No. 78503 • Standard Pack: 12 cards • \$23.00

WORLD'S GREATEST HOBBY® FIRST RAILROAD TRACK PACK



Item No. 44896 • Standard Pack: 3 • \$175.00

It's never been easier to get started in model railroading! *Our World's Greatest Hobby® First Railroad Track Pack* contains all the track you need to build a 56" x 28" N scale track layout. Also included is a copy of the DVD, *Building Your First Model Railroad*. Hosted by actor and model railroad enthusiast Michael Gross, this video features the construction of an HO scale model railroad with hints and tips that apply to every scale. Get on track for fun with the World's Greatest Hobby!



16-PIECE E-Z TRACK® GRADUATED PIER SET

Item No. 44871 • Standard Pack: 12 • \$20.00



8-PIECE E-Z TRACK® TALL PIER SET

Item No. 44872 • Standard Pack: 12 • \$16.00



MAGNET with BRAKEMAN FIGURE

Item No. 78998 • Standard Pack: 24 • \$4.00

BULK NICKEL SILVER/GRAY ROADBED E-Z TRACK® (BY THE CARTON)

- Item No. 44880 11.25" RADIUS CURVED TRACK - BULK (50 pieces per carton) \$96.00
- Item No. 44881 5" STRAIGHT TRACK - BULK (50 pieces per carton) \$96.00
- Item No. 44882 10" STRAIGHT TRACK - BULK (50 pieces per carton) \$152.00
- Item No. 44884 19" RADIUS CURVED TRACK - BULK (50 pieces per carton) \$152.00
- Item No. 44887 30" STRAIGHT TRACK - BULK (25 pieces per carton) \$305.00

Standard Pack: 1

- \$96.00
- \$96.00
- \$152.00
- \$152.00
- \$305.00



N

SCALE

SNAP-FIT E-Z TRACK®

**QUARTER SECTION
11.25" RADIUS
CURVED TRACK**
Item No. 44831 • \$7.50
(6/card)
Standard Pack: 6



**HALF SECTION
11.25" RADIUS
CURVED TRACK**
Item No. 44821 • \$11.00
(6/card)
Standard Pack: 6



**11.25" RADIUS
CURVED TRACK**
Item No. 44801 • \$12.50
(6/card)
Standard Pack: 12



*6 pieces
of track
make up
one half
(180°)
of an
11.25"
radius
circle.*

**11.25" RADIUS
TERMINAL RERAILER
with WIRE**
Item No. 44802 • \$6.50
(1/card)
Standard Pack: 12



**QUARTER SECTION
12.50" RADIUS
CURVED TRACK**
Item No. 44832 • \$8.00
(6/card)
Standard Pack: 6



**HALF SECTION
12.50" RADIUS
CURVED TRACK**
Item No. 44822 • \$12.00
(6/card)
Standard Pack: 6



**12.50" RADIUS
CURVED TRACK**
Item No. 44852 • \$14.00
(6/card)
Standard Pack: 6



**17.50" RADIUS
CURVED TRACK**
Item No. 44855 • \$13.00
(6/card)
Standard Pack: 6



**QUARTER SECTION
19" RADIUS
CURVED TRACK**
Item No. 44836 • \$7.00
(6/card)
Standard Pack: 6



**HALF SECTION
19" RADIUS
CURVED TRACK**
Item No. 44856 • \$11.00
(6/card)
Standard Pack: 6



**19" RADIUS
CURVED TRACK**
Item No. 44804 • \$16.50
(6/card)
Standard Pack: 12



*6 pieces of
track
make
up one
quarter (90°)
of a 19"
radius
circle.*

5" STRAIGHT TRACK
Item No. 44811 • \$12.50
(6/card)
Standard Pack: 12



10" STRAIGHT TRACK
Item No. 44815 • \$21.50
(6/card)
Standard Pack: 12



**10" STRAIGHT
TERMINAL RERAILER
with WIRE**
Item No. 44820 • \$9.25
(1/card)
Standard Pack: 6



**10" STRAIGHT with
UNDER-TRACK
TERMINAL**
Item No. 44897 • \$9.25
(1/card)
Standard Pack: 6



SNAP-FIT E-Z TRACK®

ASSORTED SECTIONS STRAIGHT TRACK

Item No. 44829 • \$21.00
(two each 4.50", 2.25", and
1.125" per card)
Standard Pack: 12



ASSORTED SHORT CONNECTOR SECTIONS

Item No. 44899 • \$8.75
(two each .75", .875", 1.25",
and 1.5" per card)
Standard Pack: 12



30 DEGREE CROSSING

Item No. 44840 • \$18.00
(1/card)
Standard Pack: 12



45 DEGREE CROSSING

Item No. 44843 • \$18.00
(1/card)
Standard Pack: 12



60 DEGREE CROSSING

Item No. 44842 • \$18.00
(1/card)
Standard Pack: 12



90 DEGREE CROSSING

Item No. 44841 • \$18.00
(1/card)
Standard Pack: 6



#4 TURNOUT - LEFT

Item No. 44863 • price to
be announced
(1/card)
Standard Pack: 6



#4 TURNOUT - RIGHT

Item No. 44864 • price to
be announced
(1/card)
Standard Pack: 6



REMOTE TURNOUT - LEFT

Item No. 44861 • \$22.50
(1/card)
Standard Pack: 12



REMOTE TURNOUT - RIGHT

Item No. 44862 • \$22.50
(1/card)
Standard Pack: 12



#6 WYE TURNOUT

Item No. 44869 • \$51.00
(1/card)
Standard Pack: 6



#6 SINGLE CROSSOVER TURNOUT - LEFT

Item No. 44875 • \$90.00
(1/card)
Standard Pack: 6



#6 SINGLE CROSSOVER TURNOUT - RIGHT

Item No. 44876 • \$90.00
(1/card)
Standard Pack: 6



HAYES BUMPERS

Item No. 44891 • \$14.50
(2/card)
Standard Pack: 12





SCALE

PLASTICVILLE® U.S.A.
BUILT-UPS

Plasticville® U.S.A.

O SCALE
PLASTICVILLE® U.S.A. BUILT-UPS

Standard Pack: 3

Since 1947, hobbyists and collectors have made *Plasticville® U.S.A.* products their structures of choice. Now, in addition to our traditional, easy-to-assemble kits, Bachmann is pleased to offer these pre-assembled *Plasticville® U.S.A.* buildings.

Plasticville® pieces add character and dimension to your O scale layout. Many buildings and accessories have been added to the *Plasticville®* line throughout its history, and many are still produced from their original molds. As a fun challenge to collectors, you can collect hundreds of product, color, and packaging variations that have occurred over the years (you can even join the independent Plasticville Collectors Association at plasticvilleusa.org). Whether you're new in town or an established civic leader, Bachmann builds *Plasticville® U.S.A.* for you. City growth is limited only by your imagination!



COALING STATION
Item No. 45301 • \$47.50



SPLIT-LEVEL HOUSE
Item No. 45302 • \$43.00



SCHOOL HOUSE
with PLAYGROUND EQUIPMENT
Item No. 45304 • \$43.00



TWO-STORY HOUSE
Item No. 45305 • \$43.00



TOWN HALL
Item No. 45303 • \$50.00



HOBO JUNGLE
Item No. 45306 • \$43.00



LOADING PLATFORM &
CROSSING SHANTY
Item No. 45307 • \$43.00



COUNTRY CHURCH
Item No. 45308 • \$47.00



SIGNAL BRIDGE
Item No. 45309 • \$47.00



TRAILER PARK
with TWO TRAILERS
& FLAG POLE with FLAG
Item No. 45310 • \$47.00



BANK
Item No. 45311 • \$42.00



HOSPITAL with FURNITURE
Item No. 45312 • \$47.00



CAPE COD HOUSES
(2 per box)
Item No. 45313 • \$43.00



ROADSIDE STAND
Item No. 45314 • \$37.00



APARTMENT BUILDING
Item No. 45315 • \$38.00



HOUSE UNDER CONSTRUCTION
Item No. 45316 • \$37.00



COVERED BRIDGE
Item No. 45317 • \$37.00



UNION STATION
Item No. 45318 • \$37.00

O

SCALE

PLASTICVILLE® U.S.A. KITS

Plasticville® U.S.A.

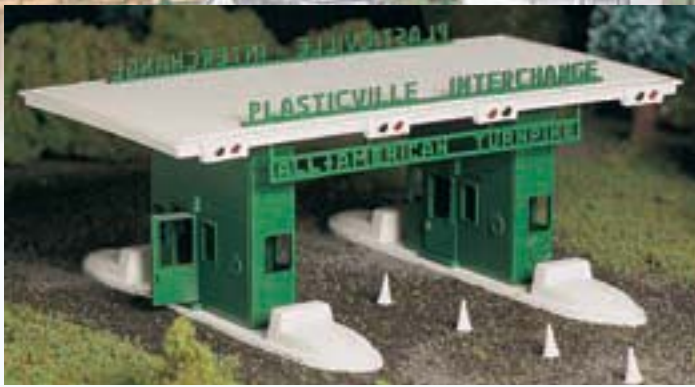
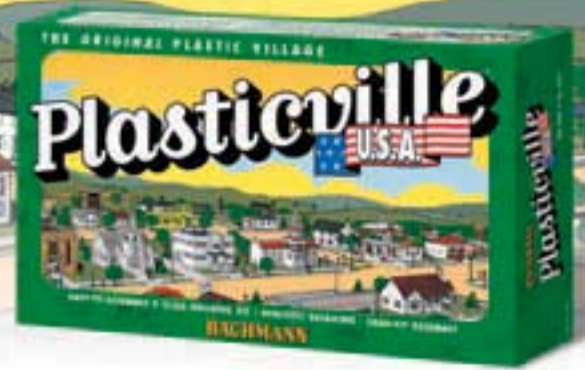

TURNPIKE INTERCHANGE
Item No. 45601 • Standard Pack: 12 • \$28.50



DAIRY BARN
Item No. 45602 • Standard Pack: 12 • \$21.50



WINDMILL with FARM MACHINERY
Item No. 45603 • Standard Pack: 12 • \$21.50



FARM OUTBUILDINGS with ANIMALS
Item No. 45604 • Standard Pack: 12 • \$17.50



DINER
Item No. 45605 • Standard Pack: 12 • \$21.50



FROSTY BAR
Item No. 45606 • Standard Pack: 12 • \$17.50



SPLIT-LEVEL HOUSE
Item No. 45607 • Standard Pack: 12 • \$28.50



CAPE COD HOUSES
(2 per box)
Item No. 45608 • Standard Pack: 12 • \$21.50



POLICE STATION with POLICE CAR
Item No. 45609 • Standard Pack: 12 • \$21.50



**FIRE HOUSE with PUMPER TRUCK,
LADDER TRUCK & FIRE CHIEF CAR**
Item No. 45610 • Standard Pack: 12 • \$28.50

Some models on these pages have been weathered and painted for illustration purposes.

O

SCALE

PLASTICVILLE® U.S.A. KITS



SCHOOL HOUSE with PLAYGROUND EQUIPMENT
Item No. 45611 • Standard Pack: 12 • \$24.00



TRAILER PARK with 3 TRAILERS & FLAG POLE with FLAG
Item No. 45612 • Standard Pack: 12 • \$21.50



TOWN HALL
Item No. 45614 • Standard Pack: 12 • \$28.50



GREENHOUSE with FLOWERS
Item No. 45615 • Standard Pack: 12 • \$24.00



MOTEL
Item No. 45618 • Standard Pack: 12 • \$21.50

Some models on these pages have been weathered and painted for illustration purposes.



ROADSIDE STAND
Item No. 45621 • Standard Pack: 12 • \$21.50



TWO-STORY HOUSE
Item No. 45622 • Standard Pack: 12 • \$24.00



SIGNAL BRIDGE
Item No. 45623 • Standard Pack: 12 • \$21.50



TRESTLE BRIDGE
Item No. 45975 • Standard Pack: 12 • \$21.50



UNION STATION
Item No. 45976 • Standard Pack: 12 • \$21.50



LOADING PLATFORM & CROSSING SHANTY
Item No. 45977 • Standard Pack: 12 • \$24.00

O

SCALE

PLASTICVILLE® U.S.A. KITS



WATER TOWER
Item No. 45978
Standard Pack: 12 • \$17.50

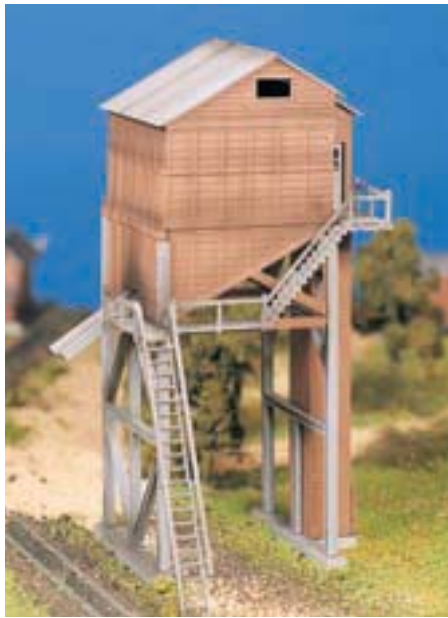

COALING STATION
Item No. 45979
Standard Pack: 12 • \$24.00



CATHEDRAL
Item No. 45981
Standard Pack: 12 • \$21.50



APARTMENT BUILDING
Item No. 45980 • Standard Pack: 12 • \$24.00



LOG CABIN with RUSTIC FENCE
Item No. 45982 • Standard Pack: 12 • \$21.50



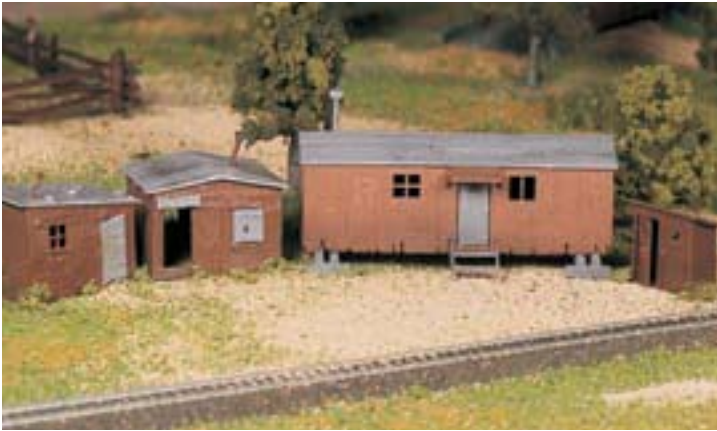

HOBO JUNGLE
(2 shacks, box car, outhouse)
Item No. 45983 • Standard Pack: 12 • \$21.50



RUSTIC FENCE
Item No. 45984 • Standard Pack: 12 • \$16.50



AIRPORT TERMINAL
Item No. 45985 • Standard Pack: 12 • \$24.00



AIRPORT HANGAR with AIRPLANES
Item No. 45986 • Standard Pack: 12 • \$24.00

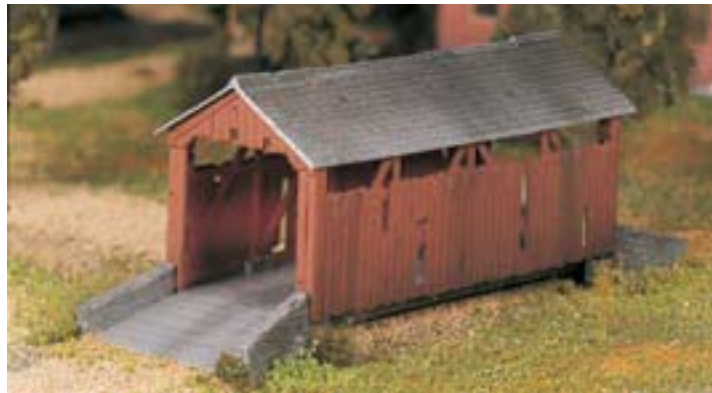

COVERED BRIDGE
Item No. 45992 • Standard Pack: 12 • \$24.00

Some models on these pages have been weathered and painted for illustration purposes.

Large
SCALE

THOMAS & FRIENDS™

Thomas with Annie & Clarabel

with international-style hook and loop couplers

Item No. 90068 • Standard Pack: 1 • \$425.00

Thomas and his loyal coaches Annie and Clarabel are carrying a number of very important passengers and you're invited to join in their adventures! A great way to begin your large scale *Thomas & Friends™* collection, this ready-to-run electric train set comes complete with Thomas the Tank Engine™ (with moving eyes), Annie coach, Clarabel coach, 5'4" x 4'3" oval of track (14 pieces), wall pack and speed controller, illustrated instruction manual, and DVD-format video instructions.



Thomas' Eyes
Move Side to Side

Percy and the Troublesome Trucks

with international-style hook and loop couplers

Item No. 90069 • Standard Pack: 1 • \$425.00

The Troublesome Trucks are needed for a hauling job, and Percy is there to make sure the work gets done without the trucks causing too much mischief! This ready-to-run electric train set comes complete with Percy the Small Engine (with moving eyes), Troublesome Truck #1, Troublesome Truck #2, a 5'4" x 4'3" oval of track (14 pieces), wall pack and speed controller, illustrated instruction manual, and DVD-format video instructions.



Percy' Eyes
Move Side to Side



SETS ARE READY TO RUN AND PROTECTED BY BACHMANN'S EXCLUSIVE LIFETIME LIMITED WARRANTY.



5'4" x 4'3"
Oval of Track

Speed Controller
with Plug-In Wiring

DVD-Format
Video Instructions

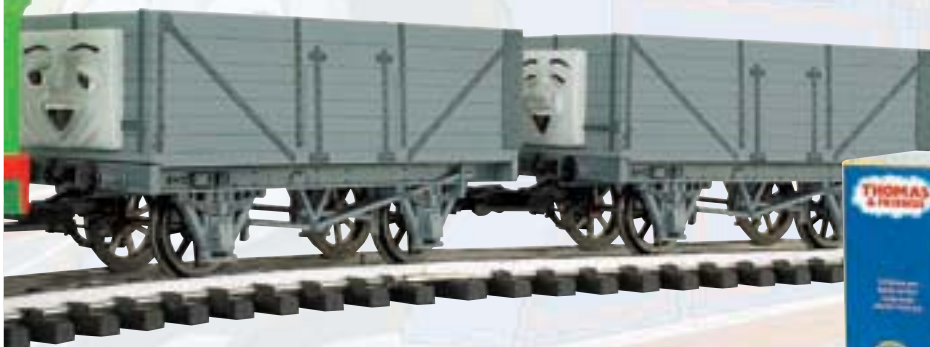

5'4" x 4'3"
Oval of Track

Speed Controller
with Plug-In Wiring

DVD-Format
Video Instructions



LARGE SCALE THOMAS & FRIENDS™ SEPARATE-SALE LOCOMOTIVES

The locomotives in this section are equipped with moving eyes and international-style hook and loop couplers. Performs best on 4' diameter curves or greater.

Standard Pack: 2 (unless otherwise noted)



THOMAS the TANK ENGINE™
(with moving eyes)
Item No. 91401 • \$235.00



PERCY the SMALL ENGINE
(with moving eyes)
Item No. 91402 • \$235.00



THOMAS SNOWPLOW
Standard Pack: 6 • Item No. 92101 • \$22.00

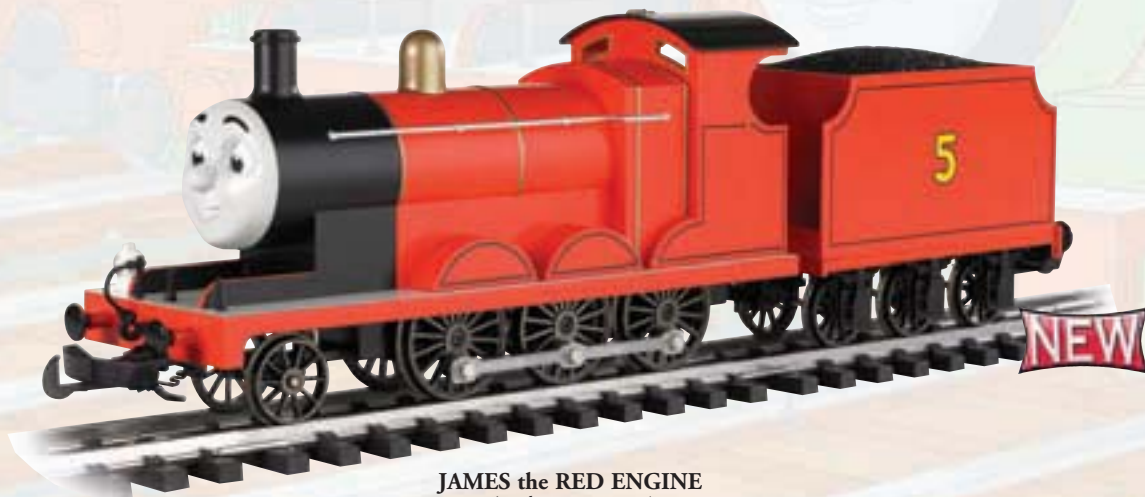

JAMES the RED ENGINE
(with moving eyes)
Item No. 91403 • \$300.00

LARGE SCALE THOMAS & FRIENDS™ SEPARATE-SALE ROLLING STOCK

The rolling stock in this section is equipped with international-style hook and loop couplers. Performs best on 4' diameter curves or greater.

Standard Pack: 4



ANNIE COACH
Item No. 97001 • \$80.00



CLARABEL COACH
Item No. 97002 • \$80.00

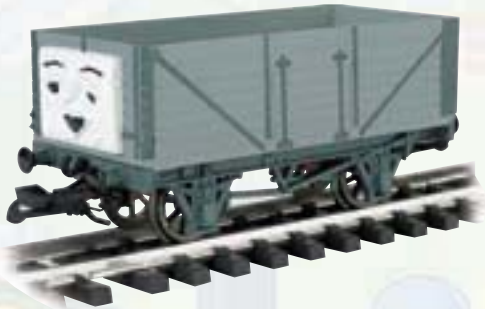

TROUBLESOME TRUCK #1
Item No. 98001 • \$80.00



TROUBLESOME TRUCK #2
Item No. 98002 • \$80.00



COAL WAGON with LOAD
Item No. 98003 • \$75.00



SODOR FUEL TANK
Item No. 98004 • \$75.00



TIDMOUTH MILK TANK
Item No. 98005 • \$75.00



CARGO CAR
Item No. 98006 • \$75.00



OIL TANK
(not shown)
Item No. 98007 • \$75.00

Silverado

Item No. 90050 • Standard Pack: 1 • \$475.00

In the years following the Civil War, the wild west offered hope to a recovering nation. The Comstock Lode promised much-needed wealth to help fund the reconstruction of the Union, but a railroad was needed to carry passengers and freight from remote silver mines to the boomtowns that sprang up around them. The Virginia & Truckee Railroad Company answered the call with trains like our *Silverado*. This ready-to-run electric train set comes complete with a 4-6-0 steam locomotive (with operating headlight, smoke, and speed-synchronized sound), tender with wood load, combine with operating door and lighted interior, observation car with lighted interior and drumhead, 8'2" x 4'3" oval of track (20 pieces), power pack and speed controller, illustrated instruction manual, and DVD-format video instructions.



White Pass & Yukon

Item No. 90059 • Standard Pack: 1 • \$540.00

Born out of the Klondike Gold Rush of the late 19th century, the White Pass & Yukon line has ably handled freight and passenger traffic for more than 100 years. Today, the WP&Y thrives as a heritage railway, allowing tourists close-up views of spectacular Alaskan scenery. This ready-to-run electric train set comes complete with an Anniversary Edition 4-6-0 steam locomotive (with operating headlight, smoke, speed-synchronized sound, metal wheels, siderods, and detail parts), coal tender, coach and observation car with metal wheels, 32 running feet of track that can build up to a giant 12' x 6' oval, engineer and fireman figures, power pack and speed controller, and illustrated instruction manual.



ALL SETS ARE READY TO RUN AND PROTECTED BY BACHMANN'S EXCLUSIVE LIFETIME LIMITED WARRANTY.

Note: Sound system and passenger car lights (if applicable) require one 9V battery each for operation. Batteries are not included.

ELECTRIC TRAIN SETS

Large
SCALE



8'2" x 4'3"
Oval of Track

Speed Controller
with Plug-In Wiring

DVD Format
Video Instructions

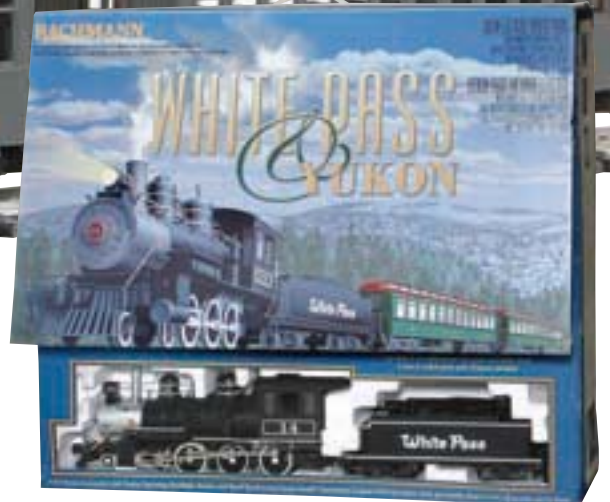

32 Running Feet of
Track Can Build from a
4'3" Circle to a
GIANT 12' x 6' Oval

Speed Controller
with Plug-In Wiring

The Plainsman **NEW**

Item No. 90078 • Standard Pack: 1 • \$395.00

Crossing the plains of the American West was a formidable task in the early days of the nation. Making the journey faster and less dangerous, pioneer wagon trains gave way to the Iron Horse in the 1860s. Our *Plainsman* set represents one of these early travelers of the West and features a Union Pacific® 4-6-0 steam locomotive (with operating headlight, smoke, and speed-synchronized sound), coal tender, stock car, bobber caboose, 5'4" x 4'3" oval of track (14 pieces), engineer and fireman figures, power pack with speed controller, illustrated "Bach-Man" instruction manual, and DVD-format video instructions.



Pennsylvanian

Item No. 90082 • Standard Pack: 1 • \$475.00

Recognized as "the Standard Railroad of America," the Pennsylvania Railroad earned the distinction of being the largest railroad in the world for much of its 122-year history. Modeled after a typical passenger train of the early twentieth century, the mighty *Pennsylvanian* serves passengers north, south, east, and west of your imagination. This ready-to-run electric train set comes complete with a PRR green 4-6-0 steam locomotive (with operating headlight, smoke, and speed-synchronized sound), coal tender, Tuscan red coach with lighted interior, observation car with lighted interior and drumhead, 8'2" x 4'3" oval of track (20 pieces), power pack and speed controller, illustrated "Bach-Man" instruction manual, and DVD-format video instructions.



ALL SETS ARE READY TO RUN AND PROTECTED BY BACHMANN'S EXCLUSIVE LIFETIME LIMITED WARRANTY.

Note: Sound system and passenger car lights (if applicable) require one 9V battery each for operation. Batteries are not included.

ELECTRIC TRAIN SETS

Large
SCALE



5'4" x 4'3"
Oval of Track



Speed Controller
with Plug-In Wiring



DVD-Format
Video Instructions

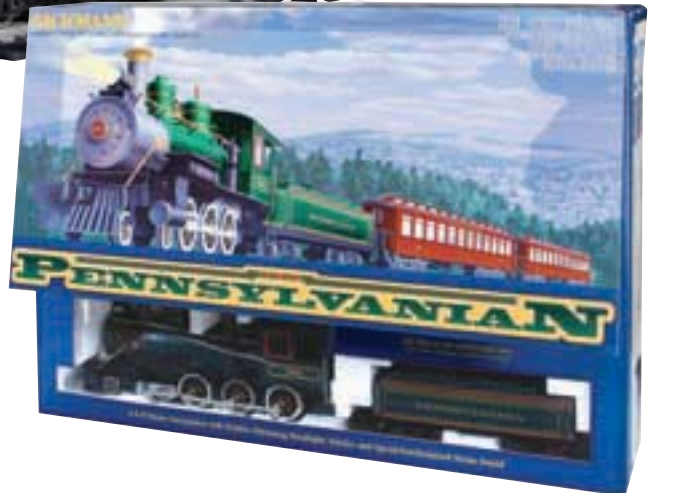

8'2" x 4'3"
Oval of Track



Speed Controller
with Plug-In Wiring



DVD-Format
Video Instructions

Tweetsie Railroad

Item No. 90033 • Standard Pack: 1 • \$495.00

Originally carrying passengers through the Blue Ridge mountains from Johnson City, Tennessee to Boone, North Carolina was the East Tennessee & Western North Carolina Railroad (ET&WNC). Operating today and listed on the National Register of Historic Places, you'll understand this train's nickname when you hear the "Tweetsie's" whistle echoing across the valleys of the Blue Ridge. This *Tweetsie Railroad* train set comes complete with a 4-6-0 steam locomotive (with operating headlight, smoke, and speed-synchronized sound), coal tender, flat car with logs, box car, combine with operating door and lighted interior, and engineer and fireman figures. Also included are an 8'2" x 4'3" oval of track (20 pieces), power pack and speed controller, illustrated "Bach-Man" instruction manual, and DVD-format video instructions.

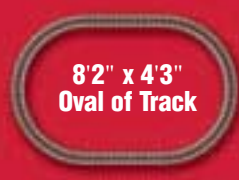

Speed Controller with Plug-In Wiring



DVD-Format Video Instructions

ALL SETS ARE READY TO RUN AND PROTECTED BY BACHMANN'S EXCLUSIVE LIFETIME LIMITED WARRANTY.

Note: Sound system and passenger car lights (if applicable) require one 9V battery each for operation. Batteries are not included.

ELECTRIC TRAIN SETS



8'2" x 4'3"
Oval of Track

Speed Controller
with Plug-In Wiring

DVD-Format
Video Instructions



Mountaineer

Item No. 90048 • Standard Pack: 1 • \$475.00

Beginning construction in the mountains of post-Civil War Tennessee, the East Tennessee and Western North Carolina Railroad Company was known locally as the “Eat Taters and Wear No Clothes” railroad. Narrow gauge operations began in 1881, and after nearly 60 years of operation, developing interstate highway systems and the torrential rains of 1940 worked to bring about the railroad’s demise. Following a series of purchases and acquisitions (singing cowboy Gene Autry once owned an ET&WNC

locomotive), the railroad was resurrected in 1956, going on to become one of North Carolina’s favorite travel attractions. Our *Mountaineer* passenger set comes complete with a 4-6-0 steam locomotive (with operating headlight, smoke, and speed-synchronized sound), coal tender, coach with lighted interior, and observation car with lighted interior. The set also includes an 8'2" x 4'3" oval of track (20 pieces), power pack and speed controller, illustrated “Bach-Man” instruction manual, and DVD-format video instructions.

Durango & Silverton - Freight

Item No. 90057 • Standard Pack: 1 • \$395.00

After founding the town of Durango, Colorado in 1880, the Denver & Rio Grande Railway began construction of a rail line the following year that connected their new community to nearby Silverton. Designed primarily to haul gold and silver from the San Juan Mountains, it is estimated that more than \$300 million in precious metals have traveled the line throughout its history.

This *Durango & Silverton Freight* set comes complete with a 4-6-0 steam locomotive (with operating headlight, smoke, and speed-synchronized sound), coal tender, box car, bobber caboose, 5'4" x 4'3" oval of track (14 pieces), power pack and speed controller, illustrated "Bach-Man" instruction manual, and DVD-format video instructions.



Durango & Silverton - Passenger

Item No. 90058 • Standard Pack: 1 • \$475.00

Built originally as a mining line, the scenic value of the *Durango & Silverton* was quickly recognized in passenger service. After surviving natural disasters, wars, and financial instability, a determined staff (and starring roles in several Hollywood movies) promoted the tourism that ensures the line's survival to this day. Now recognized as a National Historic Landmark and a National Historic Civil Engineering Landmark, the *Durango & Silverton* continues to provide year-round tourist service. Our *Durango & Silverton Passenger* set comes complete with a 4-6-0 steam locomotive (with operating headlight, smoke, and speed-synchronized sound), coal tender, coach with lighted interior, observation car with lighted interior, 8'2" x 4'3" oval of track (20 pieces), power pack and speed controller, illustrated "Bach-Man" instruction manual, and DVD-format video instructions.



ALL SETS ARE READY TO RUN AND PROTECTED BY BACHMANN'S EXCLUSIVE LIFETIME LIMITED WARRANTY.

Note: Sound system and passenger car lights (if applicable) require one 9V battery each for operation. Batteries are not included.

ELECTRIC TRAIN SETS

Large
SCALE



5'4" x 4'3"
Oval of Track



Speed Controller
with Plug-In Wiring



DVD-Format
Video Instructions



8'2" x 4'3"
Oval of Track



Speed Controller
with Plug-In Wiring



DVD-Format
Video Instructions

White Christmas[®] Express

Item No. 90076 • Standard Pack: 1 • \$475.00

Create a festive scene under your tree with this colorful Yuletide set. With a full head of steam in the boiler, your passengers will be transported on a magical holiday adventure aboard the *White Christmas[®] Express*. The *White Christmas[®] Express* comes complete with a 4-6-0 steam locomotive (with operating headlight, smoke, and speed-synchronized sound), tender with wood load, combine with operating door and lighted interior, coach car with lighted interior, 8'2" x 4'3" oval of track (20 pieces), power pack and speed controller, illustrated "Bach-Man" instruction manual, and DVD-format video instructions.



Night Before Christmas[™]

Item No. 90037 • Standard Pack: 1 • \$425.00

Perhaps there is no other gift more fun to find under the Christmas tree than a brand new train. Delivering its promise of magic and delight is the *Night Before Christmas* train set. The *Night Before Christmas* comes complete with a 4-6-0 steam locomotive (with operating headlight, smoke, and speed-synchronized sound), tender with coal load, gondola, bobber caboose, and Santa figure. Also included are a 5'4" x 4'3" oval of track (14 pieces), power pack and speed controller, illustrated "Bach-Man" instruction manual, and DVD-format video instructions.



ALL SETS ARE READY TO RUN AND PROTECTED BY BACHMANN'S EXCLUSIVE LIFETIME LIMITED WARRANTY.

Note: Sound system and passenger car lights (if applicable) require one 9V battery each for operation. Batteries are not included.



8'2" x 4'3"
Oval of Track



Speed Controller
with Plug-In Wiring



DVD-Format
Video Instructions



5'4" x 4'3"
Oval of Track



Speed Controller
with Plug-In Wiring



DVD-Format
Video Instructions

The Prospector

Item No. 90070 • Standard Pack: 1 • \$425.00

Honoring the timeless spirit of an adventurer, the *Prospector* is ready to carry precious metals and raw ore to fortune seekers everywhere. This ready-to-run electric train set comes complete with a 1:20.3 scale Davenport 0-4-0 gas mechanical locomotive with operating headlight and smoke, four side-dump ore cars, 5'4" x 4'3" oval of track (14 pieces), power pack and speed controller, illustrated instruction manual, and DVD-format video instructions.



Lumberjack

Item No. 90071 • Standard Pack: 1 • \$395.00

After the cries of "Timber!" the real work begins. It's the *Lumberjack* that will carry the load of the heaviest logs from the forest to the sawmill. This ready-to-run electric train set comes complete with a 1:20.3 scale Davenport 0-4-0 gas mechanical locomotive with operating headlight and smoke, two skeleton log cars with logs, logging caboose, 5'4" x 4'3" oval of track (14 pieces), power pack and speed controller, illustrated instruction manual, and DVD-format video instructions.



ALL SETS ARE READY TO RUN AND PROTECTED BY BACHMANN'S EXCLUSIVE LIFETIME LIMITED WARRANTY.

Note: Sound system and passenger car lights (if applicable) require one 9V battery each for operation. Batteries are not included.



5'4" x 4'3"
Oval of Track

Speed Controller
with Plug-In Wiring

DVD-Format
Video Instructions



5'4" x 4'3"
Oval of Track

Speed Controller
with Plug-In Wiring

DVD-Format
Video Instructions

1:20.3 Baldwin Industrial 2-6-0 Mogul Steam Locomotive with Tender

Performs best on 4' diameter curves or greater.

Standard Pack: 1 • \$295.00 each

Modeled after a standard Baldwin steamer, these locomotives were used for a variety of applications throughout the first half of the 20th century. Ideal for indoor and outdoor railroads, the 2-6-0 Mogul returns to the *Big Haulers*® lineup loaded with many finely detailed prototypical features.

Features include:

- updated lead truck
- polarity switch for operation according to NMRA standards or large scale model railroading practices
- smoke and speed-synchronized sound
- operating front and rear LED lights
- die-cast locomotive chassis, side rods, and valve guides
- metal handrail, grab iron details, and smoke box supports
- metal wheels
- detailed builder's plate
- all-wheel tender pickup
- precision can motor
- separate piping detail
- detailed cab interior with working firebox door

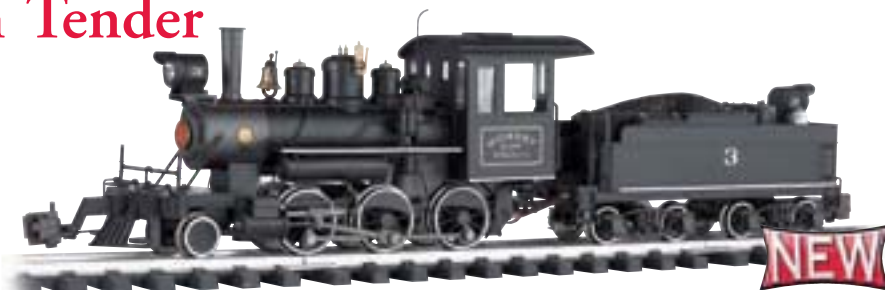

MIDWEST QUARRY & MINING CO. #3
Item No. 91552



COLORADO MINING CO. #2
Item No. 91554



YELLOW PINE LUMBER CO. #19
Item No. 91556



PAINTED, UNLETTERED - BLACK with
WHITE PINSTRIPES
Item No. 91599



2-4-2 Steam Locomotive

Performs best on 4' diameter curves or greater.

Standard Pack: 1 • \$325.00 each

Baldwin built the 2-4-2 for domestic use as well as export around the world. The “Lyn” model, named after the Lyn River in Britain, was the only American-manufactured locomotive used by the Southern Railway in England. The 2-4-2 returns to Bachmann’s *Big Haulers*® lineup, ready to be equipped with your choice of DCC decoder.

Features include:

- ready for decoder installation of your choice
- metal gearbox
- metal bearings
- all-metal wheels



LYN - SOUTHERN
Item No. 91196



PAINTED, UNLETTERED - BLACK
Item No. 91197



PAINTED, UNLETTERED - BLACK with RED
WINDOWS and WHITE PINSTRIPES
Item No. 91198



PAINTED, UNLETTERED - GREEN & BLACK with
WHITE PINSTRIPES
(not shown)
Item No. 91199

The "Annie" Is Now Even Better with Metal Gears and an Updated Lead Truck!

Anniversary Edition 4-6-0 Steam Locomotive

Performs best on 4' diameter curves or greater.

Standard Pack: 1 • \$399.00 each

With its operating headlight, smoke, and speed-synchronized sound, the 4-6-0 has long served as the backbone of our Large Scale line, providing motive power to Bachmann *Big Haulers*® sets for over two decades. With more than 1 million sold, the 4-6-0 has helped bring the hobby of model railroading to people around the

world. Nicknamed the "Annie" by posters on the "Ask the Bach-Man" message board at www.bachmanntrains.com, we're happy to offer this improved anniversary edition of the 4-6-0 Steam Locomotive with new metal gears and an updated lead truck. Combining these new features with metal siderods, separate piping, and all metal handrails, this 4-6-0 is a locomotive that Mr. Baldwin & Company would be proud to call their own.



EAST BROAD TOP #10
Item No. 91601



DENVER & RIO GRANDE WESTERN™ #178
(Bumble Bee; not shown)
Item No. 91602



RIO GRANDE SOUTHERN™ #25
Item No. 91603

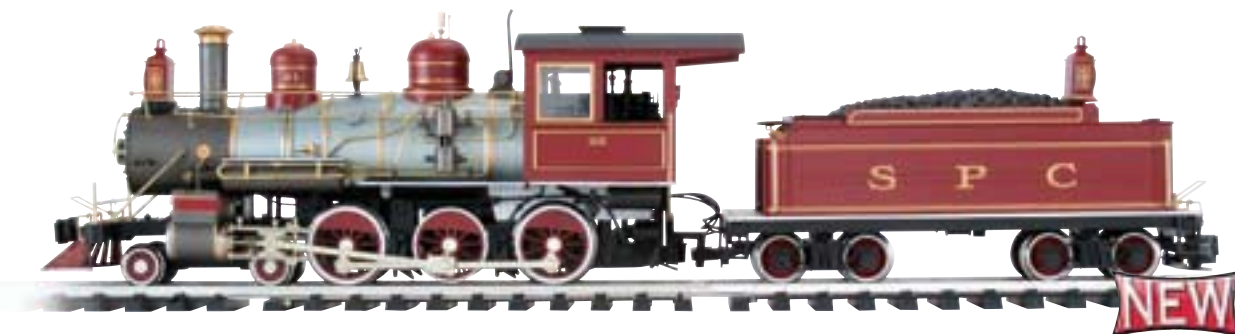

SOUTH PACIFIC COAST #22
Item No. 91604

Anniversary Edition 4-6-0 Steam Locomotive (continued)



DENVER & RIO GRANDE™ #10
Item No. 91605

NEW



ET & WNC #11
Item No. 91606

NEW



PAINTED, UNLETTERED - BLACK
Item No. 91607

NEW



Large SCALE

STREETCARS AND HANDCARS

STREETCARS

Performs best on 4' diameter curves or greater.

Standard Pack: 3

NEW

OPEN STREETCAR - MAROON & BEIGE #2259

With motorman and conductor figures, interior lighting, diode directional headlights, and flip-over seats. (not shown)

Item No. 93937 • \$165.00



CLOSED STREETCAR

With motorman and conductor figures, interior lighting, and diode directional headlights.

Item No. 93939 • \$165.00



OPEN STREETCAR - UNITED TRACTION

With motorman and conductor figures, interior lighting, diode directional headlights, and flip-over seats.

Item No. 93938 • \$165.00

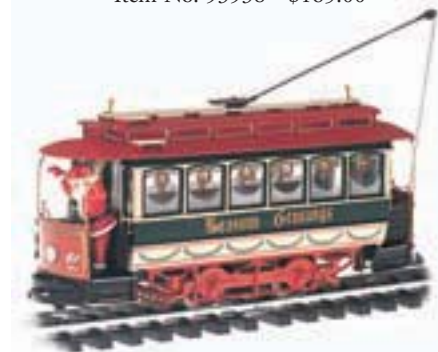

CHRISTMAS STREETCAR with SANTA

With Santa Claus motorman and elf conductor figures, interior lighting, and diode directional headlights.

Item No. 93941 • \$195.00

HAND CARS

These single, self-propelled cars feature skew-wound motors and all-gear drive. Each car and trailer can be uncoupled if desired. Performs best on 4' diameter curves or greater.

Standard Pack: 6



CHRISTMAS HAND CAR

Complete with Santa, two elves, presents, and a candy-stripe crossbuck.

Item No. 96241 • \$150.00



HAND CAR, TRAILER, 3 FIGURES & TOOLS

Complete with three crew figures and an assortment of separately molded "track gang" tools.

Item No. 96201 • \$130.00

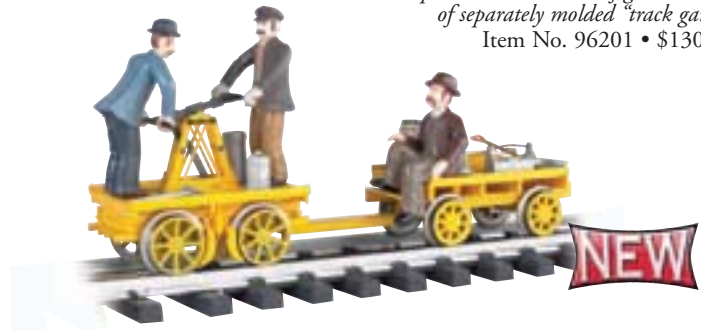

HAND CAR, TRAILER, 3 FIGURES & TOOLS

Complete with three crew figures and an assortment of separately molded "track gang" tools.

Item No. 96202 • \$130.00

PASSENGER CARS

JACKSON SHARP PASSENGER CARS with TRACK-POWERED LIGHTING

Ride in style! These classic passenger cars feature track-powered interior lighting (except Baggage Car as per prototype) and metal handrails.

All cars Standard Pack: 4



COACH "LAKE CHILKOOT"
White Pass & Yukon
Item No. 89396 • \$110.00

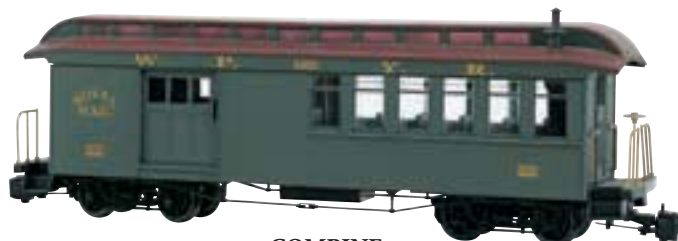

COMBINE
White Pass & Yukon
Item No. 89392 • \$110.00



FULL BAGGAGE
White Pass & Yukon
Item No. 89393 • \$110.00



OBSERVATION
White Pass & Yukon
Item No. 89394 • \$121.00



COACH
Denver & Rio Grande Western™
Item No. 89791 • \$110.00



COMBINE
Denver & Rio Grande Western™
Item No. 89792 • \$110.00



OBSERVATION
Denver & Rio Grande Western™
Item No. 89794 • \$121.00



All Bachmann
Large Scale rolling stock
is equipped with
metal wheels

Large SCALE

PASSENGER CARS AND CIRCUS CARS

JACKSON SHARP PASSENGER CARS (continued)

All cars Standard Pack: 4



COACH
East Tennessee & Western North Carolina
Item No. 89291 • \$110.00



FULL BAGGAGE
East Tennessee & Western North Carolina
Item No. 89293 • \$110.00

BACHMANN BROTHERS CIRCUS CARS

Standard Pack: 4



POLE CAR
Item No. 98380 • \$110.00



FLAT CAR with BEAR and GORILLA WAGONS
Item No. 98381 • \$120.00



FLAT CAR with GIRAFFE and HIPPO WAGONS
Item No. 98382 • \$120.00



WATER TANK CAR
Item No. 98383 • \$95.00



ZEBRA STOCK CAR with ZEBRA
Item No. 98384 • \$95.00



CABOOSE
Item No. 98385 • \$69.00

ROLLING STOCK

REEFER

Standard Pack: 6 • \$79.00 each



SANTA FE
Item No. 93202



BERKSHIRE HAM & BACON
Item No. 93268

BILLBOARD REEFER

Standard Pack: 6 • \$83.00 each



RIVERSIDE MILK DAIRY
Item No. 98661



A.C. DOLE & SON DAIRY
Item No. 98662



RIVER HORSE BREWING CO.
Item No. 98685



KENNEBEC RIVER BREWERY
Item No. 98689



DOG FISH HEAD CRAFT BREWERY
Item No. 98692



All Bachmann
Large Scale rolling stock
is equipped with
metal wheels

LOG CARS

Standard Pack: 6 • \$79.00 each

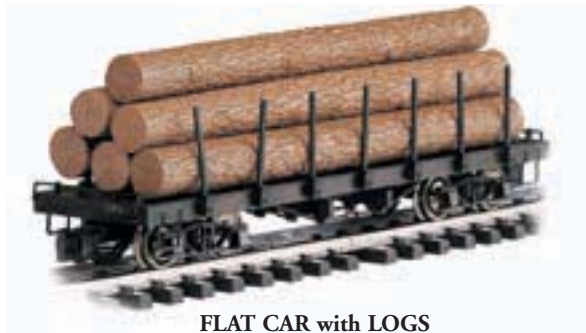

FLAT CAR with LOGS
Item No. 98470



SKELETON LOG CAR with LOGS
Item No. 98490

STOCK CAR

Standard Pack: 6 • \$79.00 each



UNION PACIFIC®
Item No. 98101



PENNSYLVANIA
Item No. 98114

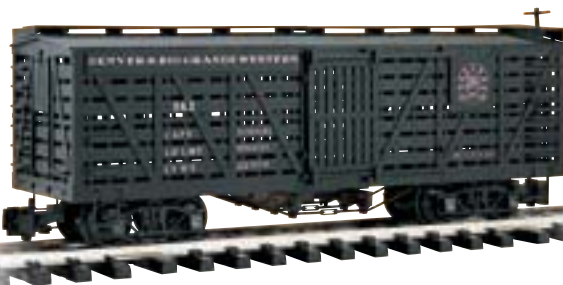

DENVER & RIO GRANDE WESTERN™
Item No. 98118

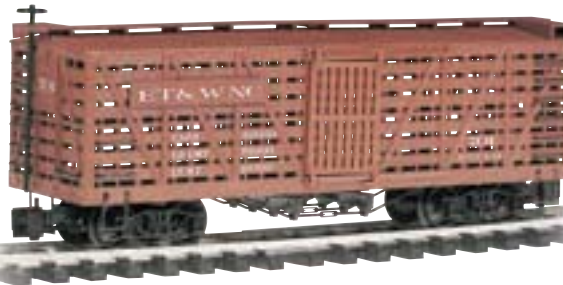

**EAST TENNESSEE
& WESTERN NORTH CAROLINA**
Item No. 98120



RIO GRANDE SOUTHERN
Item No. 98142



All Bachmann
Large Scale rolling stock
is equipped with
metal wheels

BOX CAR

Standard Pack: 6 • \$79.00 each



DENVER & RIO GRANDE WESTERN™
Item No. 93318



EAST TENNESSEE & WESTERN NORTH CAROLINA
Item No. 93320



COLORADO & SOUTHERN
Item No. 93324



EAST BROAD TOP
Item No. 93330



GREAT CENTRAL
Item No. 93364



PENNSYLVANIA RAILROAD
(Union Line)
Item No. 93368



PAINTED, UNLETTERED - BROWN
Item No. 93370



BACHMANN 175th ANNIVERSARY
Item No. 93374

Large SCALE

ROLLING STOCK

TANK CAR

Standard Pack: 6 • \$85.00 each



WHITE PASS
Item No. 93419



TEXACO
Item No. 93432



TIDEWATER
Item No. 93433



QUAKER STATE
Item No. 93436



GRAMPS
Item No. 93445



PAINTED, UNLETTERED - BLACK
Item No. 93470



All Bachmann
Large Scale rolling stock
is equipped with
metal wheels

ROLLING STOCK

GONDOLA

Standard Pack: 6 • \$79.00 each



NEW YORK CENTRAL®
Item No. 93705



DENVER & RIO GRANDE WESTERN™
Item No. 93718

NEW

VICTOR GOLD MINING
(not shown)
Item No. 93747



PAINTED, UNLETTERED - BLACK
Item No. 93770

HOPPER

Standard Pack: 6 • \$79.00 each



SOUTHERN
Item No. 98204



PEABODY
Item No. 98229



EAST BROAD TOP
with Vulcan trucks
Item No. 98230



PAINTED, UNLETTERED - RED
Item No. 98270

Large SCALE

ROLLING STOCK

WOOD ORE CAR

Standard Pack: 6 • \$79.00 each



PENNSYLVANIA
Item No. 98514



PAINTED, UNLETTERED
Item No. 98570



All Bachmann
Large Scale rolling stock
is equipped with
metal wheels

1:20.3 LARGE SCALE LOG SKIDDERS

Standard Pack: 4



LOG SKIDDER
(non-operating)
Item No. 92699 • \$60.00



NON-OPERATING LOG SKIDDER and CRATE on 20' LOG CAR
Item No. 95699 • \$115.00

1:20.3 SCALE 20' FLAT CAR

Standard Pack: 6 • \$79.00 each



BALTIMORE & OHIO™
Item No. 95612

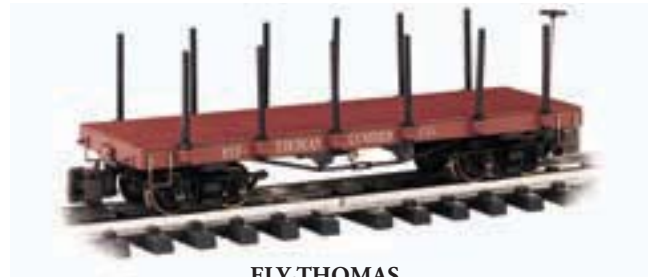

ELY-THOMAS
Item No. 95627

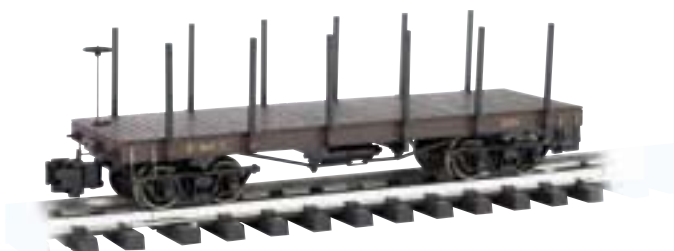

FLORENCE & CRIPPLE CREEK
Item No. 95644



PAINTED, UNLETTERED - OXIDE RED
Item No. 95670

ROLLING STOCK

1:20.3 SCALE 20' BOX CAR

Standard Pack: 6 • \$79.00 each



ELY THOMAS LUMBER CO.
Item No. 95327



LITTLE RIVER LOGGING CO.
Item No. 95355



PAINTED, UNLETTERED - OXIDE RED
Item No. 95370

1:20.3 SCALE 20' GONDOLA

Standard Pack: 6 • \$79.00 each



PACIFIC COAST
Item No. 95728



VICTOR GOLD MINING
Item No. 95747

1:20.3 SCALE ORE CARS

Standard Pack: 6 • \$56.00 each

These side-dump cars feature metal underframes and are packed one to a box.



SIDE-DUMP CAR - BROWN
Item No. 92502



SIDE-DUMP CAR - BLACK
Item No. 92503



V-DUMP CAR
Item No. 92504

Large SCALE

ROLLING STOCK

EIGHT-WHEEL CABOOSE with CENTER CUPOLA & INTERIOR

Standard Pack: 6 • \$113.00 each



GREAT NORTHERN
Item No. 93811



EAST BROAD TOP
Item No. 93827



PAINTED, UNLETTERED - OXIDE RED
Item No. 93870



All Bachmann
Large Scale rolling stock
is equipped with
metal wheels

BOBBER CABOOSE

Standard Pack: 6 • \$64.00 each

NEW

DENVER & RIO GRANDE
(not shown)
Item No. 93106



ET & WNC
Item No. 93120



EAST BROAD TOP
Item No. 93130

NEW

DENVER & RIO GRANDE WESTERN™
(not shown)
Item No. 93148

ROLLING STOCK KITS AND ACCESSORIES

ROLLING STOCK KITS

Standard Pack: 6

Build your own passenger line or kitbash the rolling stock of your dreams with these large scale kits. Metal wheels; other parts molded in gray plastic.



COACH with TRACK-POWERED LIGHTING
Item No. 89491 • \$86.00

COMBINE with TRACK-POWERED LIGHTING
Item No. 89492 • \$86.00

FULL BAGGAGE CAR
Item No. 89493 • \$74.00

OBSERVATION CAR with TRACK-POWERED LIGHTING
Item No. 89494 • \$86.00

METAL WHEEL SETS (4 per card)

Standard Pack: 6 • \$24.00 each



LARGE
31.0 mm
Item No. 92421

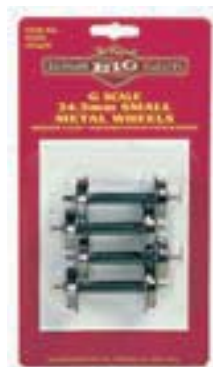

SMALL
24.5 mm
Item No. 92422

LARGE SCALE E-Z RIDERS™

Standard Pack: 6



with BALL-BEARING ROLLERS
(full electrical pick-up; 4 per pack)
Item No. 92423 • \$67.00



without ball-bearing rollers
(full electrical pick-up; 4 per pack)
Item No. 92424 • \$34.00

FIGURES

Standard Pack: 12 • \$7.75 each



- | | |
|--|----------------|
| CONDUCTOR | Item No. 92311 |
| SEATED FIGURE | Item No. 92312 |
| STATION AGENT with HAT & COAT | Item No. 92313 |
| FOREMAN | Item No. 92314 |
| BRAKEMAN with LANTERN | Item No. 92315 |
| FIREMAN with SHOVEL | Item No. 92316 |



- | | |
|-------------------------------------|----------------|
| SEATED ENGINEER | Item No. 92331 |
| MOTORMAN with BLUE UNIFORM | Item No. 92332 |
| CONDUCTOR with BLUE UNIFORM | Item No. 92333 |
| POSEABLE MAN with BOWLER HAT | Item No. 92341 |
| POSEABLE MAN with CAP | Item No. 92342 |



WEATHERED LOGS
(6 per pack)
Item No. 92201 • Standard Pack: 12 • \$36.50



CHRISTMAS CROSS-BUCKS
(2 per card)
Item No. 92202 • Standard Pack: 12 • price to be announced



TRACK TOOLS
Item No. 92411 • Standard Pack: 12 • \$8.25



TELEPHONE POLES
(12 per pack)
Item No. 92200 • Standard Pack: 12 • \$14.25



ACCESSORIES

Standard Pack: 12 • \$8.25 each

- | | |
|-----------------------------------|----------------|
| TWO CHICKEN CRATES | Item No. 92412 |
| SIX MILK CANS (two styles) | Item No. 92413 |
| TWO LARGE SHIPPING CRATES | Item No. 92414 |
| TWO SMALL SHIPPING CRATES | Item No. 92415 |
| FOUR BARRELS | Item No. 92416 |
| ONE TRUNK | Item No. 92417 |
| ONE HAND TRUCK | Item No. 92418 |

TRACK AND ACCESSORIES

MANUAL TURNOUTS

Standard Pack: 12 • \$46.00 each

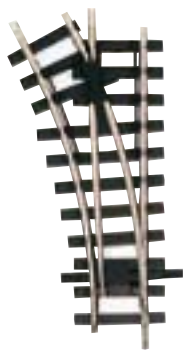

LEFT-HAND
Item No. 94351



RIGHT-HAND
Item No. 94352

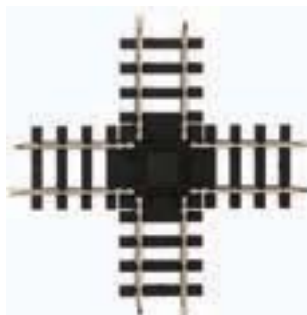

90 DEGREE CROSSING
Item No. 94358 • Standard Pack: 12 • \$55.00

To build a "figure 8" using the 90 degree crossing shown above, the following track sections are required:
4 straight sections - Item No. 94511,
and 18 curved sections - Item No. 94501.



A-FRAME BRIDGE
Item No. 96229 • Standard Pack: 4 • \$38.50



TRACK BY THE BOX • Standard Pack: 12
Item No. 94501 **CURVED** (4 pieces per box) \$37.00
Item No. 94511 **STRAIGHT** (4 pieces per box) \$37.00

TRACK BY THE CARTON • Standard Pack: 1
Item No. 94601 **CURVED** (50 pieces per carton) \$300.00
Item No. 94611 **STRAIGHT** (50 pieces per carton) \$300.00

TEN-PIECE TRESTLE SET

Item No. 96221 • Standard Pack: 4 • \$27.50



OPERATING CROSSING GATE

Item No. 96214 • Standard Pack: 4 • \$51.75



KNUCKLE COUPLERS

ONE PAIR • Item No. 92419 • Standard Pack: 12 • \$7.00
SIX PAIRS • Item No. 92420 • Standard Pack: 6 • \$25.00



BUMPERS (2 per box)

Item No. 94690 • Standard Pack: 6 • \$21.00



MINIATURE FIGURES

HO FIGURE SETS

Standard Pack: 24 • \$9.50 each



WAITING PASSENGERS
Item No. 42330



SITTING FIGURES
Item No. 42331



STANDING FIGURES
Item No. 42332



TRAIN CREW
Item No. 42333



WORK CREW
Item No. 42334



OLD WEST FIGURES
Item No. 42335



PEOPLE AT LEISURE
Item No. 42339



TRAIN WORK CREW
Item No. 42341



SITTING PASSENGERS
Item No. 42342

**MINIATURE FIGURES
AND GRASS MATS**

SCENESCAPES™ GRASS MAT

Standard Pack: 12

SceneScapes™ Grass Mats roll out to create an instant base for landscaping and scenery. Reusable and non-shedding with heavy-duty paper backing, these mats are for use with train layouts, model scenes, dioramas, and craft projects.



GRASS MAT - 100" x 50"
(covers 4' x 8' sheet of plywood)
Item No. 32901 • \$22.00



GRASS MAT - 50" x 34"
(covers 4' x 2.5' sheet of plywood)
Item No. 32902 • \$10.50

MINIATURE FIGURES

Standard Pack: 12



STROLLING PEOPLE

HO Scale • Item No. 33109 • \$9.50
O Scale • Item No. 33159 • \$13.50



STANDING PLATFORM PASSENGERS

HO Scale • Item No. 33110 • \$9.50
O Scale • Item No. 33160 • \$13.50



SEATED PLATFORM PASSENGERS

HO Scale • Item No. 33111 • \$9.50
O Scale • Item No. 33161 • \$13.50



BUSINESSMEN

HO Scale • Item No. 33112 • \$9.50
O Scale • Item No. 33162 • \$13.50



MECHANICS

HO Scale • Item No. 33113 • \$9.50
O Scale • Item No. 33163 • \$13.50



BUILDING SITE ACCESSORIES

HO Scale • Item No. 33114 • \$9.50
O Scale • Item No. 33164 • \$13.50

MINIATURE FIGURES (continued)



CITY PEOPLE

HO Scale • Item No. 33101 • \$9.50

O Scale • Item No. 33151 • \$13.50



COWS - BROWN & WHITE

HO Scale • Item No. 33102 • \$9.50

O Scale • Item No. 33152 • \$13.50



COWS - BLACK & WHITE

HO Scale • Item No. 33103 • \$9.50

O Scale • Item No. 33153 • \$13.50



POLICE SQUAD

HO Scale • Item No. 33104 • \$9.50

O Scale • Item No. 33154 • \$13.50



CONSTRUCTION WORKERS

HO Scale • Item No. 33105 • \$9.50

O Scale • Item No. 33155 • \$13.50



MAINTENANCE WORKERS

HO Scale • Item No. 33106 • \$9.50

O Scale • Item No. 33156 • \$13.50



CATS with GARBAGE CAN

HO Scale • Item No. 33107 • \$9.50

O Scale • Item No. 33157 • \$13.50



DOGS with FIRE HYDRANT

HO Scale • Item No. 33108 • \$9.50

O Scale • Item No. 33158 • \$13.50

TREES

SCENESCAPES™ TREES

HO and N Scale Standard Pack: 12

O Scale Standard Pack: 6

Bring your urban or countryside railroad to life with realistic *SceneScapes™* trees by Bachmann. Create your own grove or blanket a hillside in dense forest with deciduous and coniferous trees offered in a variety of sizes. Though suitable for all scales, the most common size/scale association is denoted in parentheses after each description (N, HO, or O). Please note the number of trees per box may vary from the photos as shown. The number of trees contained in each box is also indicated in parentheses.

- for use with all train layouts
- realistic colors
- size assortment for added realism



3"- 4" PINE TREES (N)
(9 per box)
Item No. 32101 • \$12.50

5"- 6" PINE TREES (HO)
(6 per box)
Item No. 32001 • \$11.50

8"-10" PINE TREES (O)
(3 per box)
Item No. 32201 • \$17.00



3"- 4" PINE TREES with SNOW (N)
(9 per box)
Item No. 32102 • \$12.50

5"- 6" PINE TREES with SNOW (HO)
(6 per box)
Item No. 32002 • \$11.50

8"-10" PINE TREES with SNOW (O)
(3 per box)
Item No. 32202 • \$17.00



3"- 4" CONIFER TREES (N)
(9 per box)
Item No. 32103 • \$12.50

5"- 6" CONIFER TREES (HO)
(6 per box)
Item No. 32003 • \$11.50

8"- 10" CONIFER TREES (O)
(3 per box)
Item No. 32203 • \$17.00



3"- 4" SPRUCE TREES (N)
(9 per box)
Item No. 32104 • \$12.50

5"- 6" SPRUCE TREES (HO)
(6 per box)
Item No. 32004 • \$11.50

8"- 10" SPRUCE TREES (O)
(3 per box)
Item No. 32204 • \$17.00



3"- 4" CEDAR TREES (N)
(9 per box)
Item No. 32105 • \$12.50

5"- 6" CEDAR TREES (HO)
(6 per box)
Item No. 32005 • \$11.50

8"- 10" CEDAR TREES (O)
(3 per box)
Item No. 32205 • \$17.00



2"- 3" DECIDUOUS TREES (N)
(4 per box)
Item No. 32106 • \$12.50

3"- 4" DECIDUOUS TREES (HO)
(3 per box)
Item No. 32006 • \$12.50

5.5"- 6.5" DECIDUOUS TREES (O)
(2 per box)
Item No. 32206 • \$17.00



2"- 2.25" WALNUT TREES (N)
(4 per box)
Item No. 32107 • \$12.50

2.5"- 3.5" WALNUT TREES (HO)
(3 per box)
Item No. 32007 • \$12.50

5" WALNUT TREES (O)
(2 per box)
Item No. 32207 • \$19.00



2.5"- 2.75" ELM TREES (N)
(4 per box)
Item No. 32108 • \$12.50

3"- 4" ELM TREES (HO)
(3 per box)
Item No. 32008 • \$12.50

5.5" ELM TREES (O)
(2 per box)
Item No. 32208 • \$19.00



2.5"- 2.75" SYCAMORE TREES (N)
(4 per box)
Item No. 32109 • \$12.50

3"- 4" SYCAMORE TREES (HO)
(3 per box)
Item No. 32009 • \$12.50

8" SYCAMORE TREES (O)
(2 per box)
Item No. 32209 • \$19.00



2.5"- 2.75" ASPEN TREES (N)
(4 per box)
Item No. 32110 • \$12.50

3"- 4" ASPEN TREES (HO)
(3 per box)
Item No. 32010 • \$12.50

8" ASPEN TREES (O)
(2 per box)
Item No. 32210 • \$19.00



2.5"- 2.75" MAPLE TREES (N)
(4 per box)
Item No. 32111 • \$12.50

3"- 4" MAPLE TREES (HO)
(3 per box)
Item No. 32011 • \$12.50

8" MAPLE TREES (O)
(2 per box)
Item No. 32211 • \$19.00



3"- 4" BLUE SPRUCE TREES (N)
(not shown; 9 per box)
Item No. 32112 • \$12.50

5"- 6" BLUE SPRUCE TREES (HO)
(not shown; 6 per box)
Item No. 32012 • \$11.50

8"- 10" BLUE SPRUCE TREES (O)
(not shown; 3 per box)
Item No. 32212 • \$17.00



2.25"- 2.5" OAK TREES (N)
(not shown; 4 per box)
Item No. 32113 • \$12.50

3"- 3.5" OAK TREES (HO)
(not shown; 3 per box)
Item No. 32013 • \$12.50

4.5"- 5" OAK TREES (O)
(not shown; 2 per box)
Item No. 32213 • \$19.00



2.25"- 2.5" WILLOW TREES (N)
(not shown; 4 per box)
Item No. 32114 • \$12.50

3"- 3.5" WILLOW TREES (HO)
(not shown; 3 per box)
Item No. 32014 • \$12.50

5"- 5.5" WILLOW TREES (O)
(not shown; 2 per box)
Item No. 32214 • \$19.00

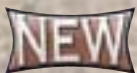

BULK TREES

Item No. 32153
Item No. 32154
Item No. 32155
Item No. 32156
Item No. 32157
Item No. 32158
Item No. 32159
Item No. 32160

3"-4" PINE TREES with SNOW (N) (36 per bag)
5"-6" PINE TREES with SNOW (HO) (24 per bag)
3"-4" CONIFER TREES (N) (36 per bag)
5"-6" CONIFER TREES (HO) (24 per bag)
3"-4" SPRUCE TREES (N) (36 per bag)
5"-6" SPRUCE TREES (HO) (24 per bag)
3"-4" CEDAR TREES (N) (36 per bag)
5"-6" CEDAR TREES (HO) (24 per bag)

Standard Pack: 6
\$36.00
\$36.00
\$36.00
\$36.00
\$36.00
\$36.00
\$36.00
\$36.00

LANDSCAPING

SCENESCAPES™ WIRE FOLIAGE BRANCHES

(60 branches, 1" - 3" inches in length)

Standard Pack: 6 • \$10.95 each



MEDIUM GREEN
Item No. 32644



LIGHT GREEN
Item No. 32645



DARK GREEN
Item No. 32646



SCENESCAPES™ FOLIAGE FIBER

(approximately one square foot)

Standard Pack: 6 • \$4.95 each



LIGHT GREEN
Item No. 32631



MEDIUM GREEN
Item No. 32632



DARK GREEN
Item No. 32633



SCENESCAPES™ FOLIAGE

(approximately 30 cubic inches)

Standard Pack: 6 • \$4.95 each



LIGHT GREEN - MEDIUM
Item No. 32602



MEDIUM GREEN - MEDIUM
Item No. 32605



DARK GREEN - MEDIUM
Item No. 32608



EARLY FALL - MEDIUM
Item No. 32611



LATE FALL - MEDIUM
Item No. 32614



SCENESCAPES™ TURF

(approximately 60 cubic inches)

Standard Pack: 6 • \$8.95 each



CONIFER GREEN - MEDIUM
Item No. 32852



FOREST GREEN - MEDIUM
Item No. 32855

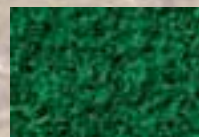

GRASS GREEN - MEDIUM
Item No. 32858



SPRING GREEN - MEDIUM
Item No. 32861

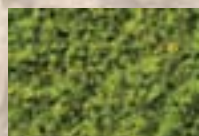

LIGHT GREEN - MEDIUM
Item No. 32864



SCENESCAPES™ GROUND COVER

(approximately 60 cubic inches)

Standard Pack: 6 • \$8.95 each



SOIL - FINE
Item No. 32801



EARTH - FINE
Item No. 32802



EARTH - COARSE
Item No. 32803



GOLDEN STRAW - FINE
Item No. 32804



GOLDEN STRAW - COARSE
Item No. 32805



YELLOW STRAW - FINE
Item No. 32806



YELLOW STRAW - COARSE
Item No. 32807



BURNT GRASS - FINE
Item No. 32808



BURNT GRASS - COARSE
Item No. 32809



MOSS GREEN - FINE
Item No. 32810



MOSS GREEN - COARSE
Item No. 32811

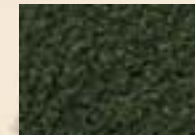

DARK GREEN - FINE
Item No. 32812



DARK GREEN - COARSE
Item No. 32813

SCENESCAPES™ TURF BLEND

(approximately 60 cubic inches)

Standard Pack: 6 • \$8.95 each



GREEN - MEDIUM
Item No. 32832

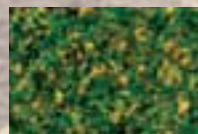

AUTUMN - MEDIUM
Item No. 32834



EARLY FALL - MEDIUM
Item No. 32836



LATE FALL - MEDIUM
Item No. 32838

GRAVEL

SCENESCAPES™ GRAVEL

(approximately 350 grams)

Standard Pack: 6 • \$4.95 each



LIGHT TAN - FINE
Item No. 32701



LIGHT TAN - MEDIUM
Item No. 32702



LIGHT TAN - COARSE
Item No. 32703



GRAY - FINE
Item No. 32716



GRAY - MEDIUM
Item No. 32717



GRAY - COARSE
Item No. 32718



COAL BLACK - FINE
Item No. 32719



COAL BLACK - MEDIUM
Item No. 32720



COAL BLACK - COARSE
Item No. 32721



GRAY BLEND - FINE
Item No. 32722



GRAY BLEND - MEDIUM
Item No. 32723



GRAY BLEND - COARSE
Item No. 32724



DARK GRAY - FINE
Item No. 32725



DARK GRAY - MEDIUM
Item No. 32726



DARK GRAY - COARSE
Item No. 32727



BEIGE MIX - FINE
Item No. 32728



BEIGE MIX - MEDIUM
Item No. 32729



BEIGE MIX - COARSE
Item No. 32730



WHITE MIX - FINE
Item No. 32731



WHITE MIX - MEDIUM
Item No. 32732



WHITE MIX - COARSE
Item No. 32733





E-Z LUBE® AND POWER PACKS

INDIVIDUALLY PACKAGED LUBRICANTS

Standard Pack: 12 • \$16.00 each



CONDUCTIVE CONTACT LUBE
(1 fl oz.)
Item No. 99981



GREASE
(0.5 oz.)
Item No. 99982



HEAVY GEAR OIL
(1 fl oz.)
Item No. 99983



LIGHT GEAR OIL
(1 fl oz.)
Item No. 99984

Lubricants for Model Railroad Professionals

For the best care and maintenance of motive power, rolling stock, and track, Bachmann has a full line of premium-grade lubricants. Four *E-Z Lube*® products are offered:

- light gear oil
- heavy gear oil
- heavy duty grease
- conductive contact lubricant

Each of the lubricants has a specific purpose. The light gear oil is for use on all gears, bushings, shafts, and bolsters. It is non-shedding and will not “sling off.” The heavy gear oil lubricates for extended periods of time and is formulated for use on motor bushings, bearings, valve gear, side rods, and draft gear boxes. For applications requiring heavier viscosity material, such as Large Scale trains, it's best to use the heavy duty grease. And for superior electric motor maintenance and track cleaning, your choice is the conductive contact lubricant.

With proper maintenance, you can extend the life and enjoyment of your railroad equipment for many, many years. We urge you to establish a sensible maintenance schedule and to use our *E-Z Lube*® products for professional care.



SMOKE FLUID
(2 fl oz.)
Item No. 99993
Standard Pack: 24 • \$8.50

POWER PACKS

Standard Pack: 6



POWER PACK and SPEED CONTROLLER
(appropriate for N, HO, and On30 scale trains; DCC compatible)
Item No. 44212 • \$59.00



LARGE SCALE POWER PACK and SPEED CONTROLLER
(appropriate for Large Scale trains; not DCC compatible)
Item No. 44213 • \$70.00

Patent Pending

HO Scale • N Scale • On30 Scale • Large Scale

Spectrum®



Ken Patterson

Set design and photography by Ken Patterson.

Now that's the way to run a railroad!®

SOUNDING OFF

Bachmann Trains offers an extensive line of DCC Sound-equipped *Spectrum*® locomotives. Working closely with SoundTraxx®, we're pleased to offer HO, On30, and Large Scale engines equipped with Tsunami® sound technology. Using sounds taken from real locomotives, modelers can add a new level of realism to their railroads with a broad palette of prototypical sound effects and DCC functions. Plus, the dual-mode decoders work on both DC and DCC layouts automatically.

Break the silence on your railroad. See the product guide on the following page for the key to our SOUND ON BOARD™ locomotives.

Decoder features include:

- authentic sound effects uniquely appropriate to each model including whistles, bells, chuffs, and air pumps
- additional sounds include dynamo, injectors, coupler clank, water stop, and more
 - three whistles to choose from in each model
- whistle can be played in real time to create authentic whistle signals
 - high-quality 16-bit digital sound
- advanced motor control features including Load Compensation and Silent Drive to provide smooth, quiet operation
 - supports all recognized programming methods

Tsunami
Spectrum®





Since the introduction of our first *Spectrum*[®] locomotive in 1988, Bachmann has expanded the *Spectrum*[®] line to include motive power and rolling stock from many eras in N, HO, On30, and Large Scale. As always, the *Spectrum*[®] philosophy is to produce the highest-quality products at an affordable price. As we expand and vary the *Spectrum*[®] line, our models continue to change in order to feature the latest model railroading technology. Bachmann currently produces locomotives that are DCC ready, DCC equipped, and DCC sound equipped.

Our *DCC ON BOARD*[™] motive power features dual-mode NMRA-compliant decoders for control of speed, direction and lighting. *DCC SOUND ON BOARD*[™] motive power incorporates Soundtraxx[®] *Tsunami*[®] technology with a 16-bit processor that contains a unique suite of sounds including whistles, bells, chuffs, and much more.

To help you distinguish among the various types of *Spectrum*[®] products, we have included color-coded sidebars in this section of the catalog. Below is a list of the product categories and their corresponding color codes.

N SCALE DCC ON BOARD[™] - Black



HO SCALE DCC ON BOARD[™] – Red



HO SCALE DCC SOUND ON BOARD[™] – Blue



On30 SCALE DCC ON BOARD[™] - Green



On30 SCALE DCC SOUND ON BOARD[™] – Brown



LARGE SCALE DCC SOUND ON BOARD[™] - Red



Now that's the way to run a railroad![®]

Dynamis® Sound Commander



Standard Pack: 1 • \$599.00

Experience the ultimate in digital sound and control with the *Dynamis*® Sound Commander set. Everything you need to get started in the world of digital command control is included. Locomotives, turnouts, and accessories can be controlled with the *E-Z Command*® *Dynamis*® system that allows the operator total freedom by integrating two-way wireless technology into an advanced digital command control system. Our exclusive *Dynamis*® DCC system lets you control the speed, direction, lighting, and sound functions of the decoder-equipped 2-8-0 steam locomotive featuring authentic sound effects uniquely appropriate to this model. Operator-controlled functions include whistle, bell, chuff, air pump, and more in high-quality 16-bit digital sound. A 56" x 38" oval of nickel silver *E-Z Track*® with a decoder-equipped turnout and siding will quickly have you performing switching operations like a pro. For DCC operation and *Spectrum*® quality, the *Dynamis*® Sound Commander set is sure to please the beginner and serious enthusiast alike.

Features include:

- Baldwin 2-8-0 locomotive with operating headlight and tender
- DCC-equipped for sound, speed, direction, and lighting
- three-dome tank car
- gondola
- box car
- quad hopper
- bobber caboose
- *E-Z Command*® *Dynamis*® wireless digital command control system
- 56" x 38" oval of nickel silver *E-Z Track*® with decoder-equipped turnout and siding. Track set includes 12 pieces curved track, 4 pieces straight track, 1 terminal rerailer, 1 decoder equipped nickel silver *E-Z Track*® turnout-left, under-track magnet with brakeman figure, and 1 Hayes bumper
- DVD-format and illustrated instruction manuals



Decoder features include:

- authentic sound effects uniquely appropriate to each model
- three whistles to choose from in each model
- real-time whistle for creating authentic signals
- high-quality 16-bit digital sound
- advanced motor control features, including load compensation and silent drive to provide smooth, quiet operation
- supports all recognized programming methods

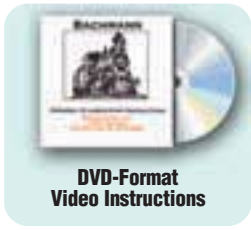

DVD-Format
Video Instructions

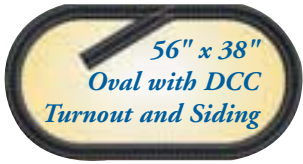

*Dynamis® Wireless Infrared Handset
with Backlit LCD Screen*



NEW

CHESAPEAKE & OHIO®
Item No. 01401



NEW

NEW HAVEN
Item No. 01402



NEW

MAINE CENTRAL
Item No. 01403

SOUND ON BOARD

Acela Express® Set

NEW



Item No. 01204 • Standard Pack: 1 • \$450.00

The high-speed passenger train that revolutionized rail travel comes to layouts everywhere courtesy of Bachmann Industries. As an official Amtrak licensee of the *Acela Express*® train, we're proud to present this DCC-equipped model in our award-winning *Spectrum*® line. Our *Acela Express*® features the latest in technology and tool making, and its powerful locomotive can reach scale speeds of 150 mph or more. The *Acela Express*® set comes complete with dual locomotives (one powered, one non-powered), a first class passenger car, business class passenger car, and Café Acela® car. Also included are a 22" radius, 81" x 45" nickel silver *E-Z Track*® oval, power pack and speed controller, and DVD-format video with assembly instructions.



A typical *Acela Express*® consist includes: 2 Locomotives, 1 First Class, 1 Café Acela®, 1 End-Business and 3 Business Class Cars. For separate sale cars to make up this arrangement, see the listings on page 192.

Nor'easter

Item No. 01313 • Standard Pack: 3 • \$355.00

The double-ended HHP-8 (high horsepower with 8000 hp) can haul lengthy runs of Amfleet cars at speeds up to 125 miles per hour. Sometimes referred to by train crews as the "Hippo," the powerful HHP-8 can be seen storming the rails along Amtrak's Northeast Corridor.



Acela® HHP-8 locomotive features:

- DCC ready
- interior selector switch for choice between rail and pantograph operation
- die-cast gear towers and chassis
- precision motor

Set also includes:

- two *Acela*® regional coaches with lighted interiors
- *Acela*® regional café with lighted interior
- 63" x 45" oval of nickel silver *E-Z Track*®, including 16 pieces 22" radius curved track, 3 pieces 9" straight track, and 1 plug-in terminal rerailer

- power pack and speed controller
- illustrated instruction manual
- DVD-format video with assembly instructions



81" x 45"
Oval

Locomotive features:

- DCC-equipped for speed, direction, and lighting
- interior selector switch for choice between rail and pantograph operation
- die-cast gear towers and chassis
- precision motor
- working directional headlights, ditch lights, and markers
- operating doors

Passenger Car features:

- tilting chassis to travel smoothly around curves at high speeds
- flush windows
- lighted interiors
- blackened RP25 wheels
- photo-etched, blackened brass inserts on air ducts
- finescale interior detail, including passenger seats and tables



DVD-Format
Video Instructions



DVD-Format
Video Instructions



THIS PRODUCT EQUIPPED
WITH BODY-MOUNTED
E-Z MATE® MARK II COUPLERS

63" x 45"
Oval



The Cavalier

Item No. 01314 • Standard Pack: 3 • \$490.00



Primarily known for its coal hauling operations, the Norfolk and Western Railroad ventured into passenger service with trains such as the *Cavalier*. Traveling between Cleveland and Norfolk, passengers enjoyed the journey in comfort and ease as they raced along the rails. This set showcases locomotive #611 as it appeared in the 1980s to 1990s.

Features include:

- Class J 4-8-4 locomotive (Railfan #611) with tender and operating headlight
- DCC-equipped for speed, direction, and lighting
- combine with interior lighting
- coach with interior lighting
- observation car with interior lighting
- 63" x 45" oval of nickel silver *E-Z Track*®, including 16 pieces of 22" radius curved track, 3 pieces straight track, and 1 plug-in terminal railer
- power pack and speed controller
- DVD-format video with assembly instructions



BODY-MOUNTED
E-Z MATE®
MARK II COUPLERS

Acela Express® Locomotives and Passenger Cars

Performs best on 22" radius curves or greater.

Standard Pack: 6

Acela Express® locomotives and passenger cars are available individually. Modelers can accurately duplicate Amtrak's standard eight-car, high-speed commuter train by adding additional passenger cars to the *Spectrum*® *Acela Express*® train set.

The separate-sale cars also allow you to build your own train one car at a time. Our separate locomotives and passenger cars have the same finescale details as the models in the ready-to-run set, and are part of our award-winning *Spectrum*® series.

Note: a typical Acela Express® train includes: 2 Locomotives, 1 First Class, 1 Café Acela®, 1 End-Business and 3 Business Class Cars.



DUAL LOCOMOTIVES #2001, 2018

(one powered, one non-powered; choice between rail and pantograph operation)
Item No. 81945 • \$258.00



CAFÉ ACELA®
(with lighted interior)
Item No. 89941 • 60.00



FIRST CLASS
(with lighted interior)
Item No. 89942 • \$60.00



BUSINESS CLASS
(with lighted interior)
Item No. 89943 • \$60.00



END-BUSINESS CLASS
(with lighted interior)
Item No. 89944 • \$60.00



Spectrum DCC ON BOARD System



Acela® HHP-8

Performs best on 18" radius curves or greater.

Standard Pack: 6 • \$230.00

Beginning regional service in 2002, high horsepower (*HHP-8*) locomotives were built to extend the range of Amtrak's fleet of high-speed passenger trains. Our HO scale model of this double-ended powerhouse is equipped with the same proven drive train found in our *Acela*® locomotive.

Features include:

- DCC-equipped for speed, direction, and lighting
- interior selector switch for choice between rail and pantograph operation
- die-cast gear towers and chassis
- precision motor
- directional headlights, ditch lights, and markers
- operating doors



HHP-8 #656
Item No. 83011



HHP-8 #651
Item No. 83012



HHP-8 #663
Item No. 83013

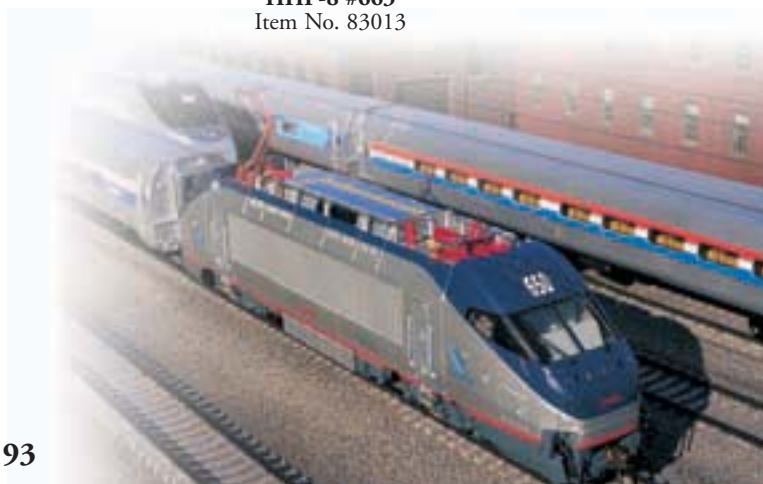

BODY-MOUNTED
E-Z MATE®
MARK II COUPLERS



70-Ton Three-Truck Climax Locomotive

Performs best on 15" radius curves or greater.

Standard Pack: 6 • \$535.00 each



In 1897, the Climax Manufacturing Company built its first locomotive with three power trucks, which was designated as Class "C." The addition of the third truck allowed the locomotive to go longer distances between water stops and provided greater traction and a more stable engine. This HO version is packed with all the features you would find in larger-scale models plus Soundtraxx® Tsunami® sound technology that lets you enjoy every authentic whistle, bell, chuff, clang, and more in realistic high-quality 16-bit sound.

Features include:

- DCC sound-equipped
- dual-mode NMRA-compliant decoder with 8-pin plug
- die-cast construction
- precision can motor
- all-wheel electrical pickup
- three-gearbox power train for realistic operation
- scale-speed gearing
- detailed cab interior
- LED headlight and backup light
- separately applied stack, domes, and cab
- separate detail parts, including bell, whistle, pop valves, and handrails
- Walschaerts valve gear
- prototype-specific pumps
- E-Z Mate® Mark II couplers

Decoder features include:

- authentic sound effects uniquely appropriate to each model
- three whistles to choose from in each model
- real-time whistle for creating authentic signals
- high-quality 16-bit digital sound
- advanced motor control features, including load compensation and silent drive to provide smooth, quiet operation
- supports all recognized programming methods



PAINTED, UNLETTERED - BLACK
Item No. 82926



PAINTED, UNLETTERED - BLACK with RED
WINDOWS and WHITE STRIPES
Item No. 82927



MOORE-KEPPEL & CO. #6
Item No. 82928



CASS SCENIC RR #9
Item No. 82929



CLEAR LAKE LUMBER CO. #12
Item No. 82930



CLIMAX #3
(demonstrator)
Item No. 82931



70-Ton Three-Truck Climax Locomotive

Performs best on 15" radius curves or greater.

Standard Pack: 6 • \$385.00 each

In 1897, the Climax Manufacturing Company built its first locomotive with three power trucks, which was designated as Class "C." The addition of a third truck allowed the locomotive to go longer distances between water stops and provided greater traction and a more stable engine. This HO version is packed with all the features you would find in larger-scale models.

Features include:

- DCC-equipped for speed, direction, and lighting
- dual-mode NMRA-compliant decoder with 8-pin plug
- die-cast construction
- precision can motor
- all-wheel electrical pickup
- three-gearbox power train for realistic operation
- scale-speed gearing
- detailed cab interior
- LED headlight and backup light
- separately applied stack, domes, and cab
- separate detail parts, including bell, whistle, pop valves, and handrails
- Walschaerts valve gear
- prototype-specific pumps
- E-Z Mate® Mark II couplers



PAINTED, UNLETTERED - BLACK
Item No. 82901



PAINTED, UNLETTERED - BLACK with RED
WINDOWS and WHITE STRIPES
Item No. 82902



MOORE-KEPPELE & CO. #6
Item No. 82903



CLEAR LAKE LUMBER CO. #12
Item No. 82905



CASS SCENIC RR #9
Item No. 82904



CLIMAX #3
(demonstrator)
Item No. 82906



ALL PRODUCTS ON THESE PAGES
EQUIPPED WITH BODY-MOUNTED
E-Z MATE® MARK II COUPLERS



DCC ON BOARD

C&O H-4 2-6-6-2 Articulated Locomotive with Vandy VC12 Tender



Performs best on 22" radius curves or greater.

Standard Pack: 6 • \$550.00

The H-4 was the first engine in a series of over 200 locomotives employed by the C&O railroad which operated more 2-6-6-2 articulated locos than any other railroad in the world. These locomotives were often referred to as "vest pocket articulateds" because they were small yet very powerful.

Features include:

- DCC sound-equipped
- dual-mode NMRA-compliant decoder with 8-pin plug
- die-cast boiler
- precision motor
- two flywheels
- geared drive
- electrical pickup on drivers
- operating LED headlight
- finescale metal detail parts, including metal cut levers and separately applied bell, whistle, domes and piping
- detailed cab interior with sliding windows
- RP25 wheel contours
- body-mounted NMRA coupler pockets
- E-Z Mate® Mark II couplers on front and rear

Tender features:

- C&O VC12 Vandy tender
- VC12 truck side frames
- easy decoder access
- detailed underframe with brake cylinder
- all-wheel electrical pickup
- hand-tooled coal load
- detailed coal boards
- metal handrails and finescale rivet detail

Decoder features include:

- authentic sound effects uniquely appropriate to each model
- three whistles to choose from in each model
- real-time whistle for creating authentic signals
- high-quality 16-bit digital sound
- advanced motor control features, including load compensation and silent drive to provide smooth, quiet operation
- supports all recognized programming methods



PAINTED, UNLETTERED - BLACK
Item No. 84811

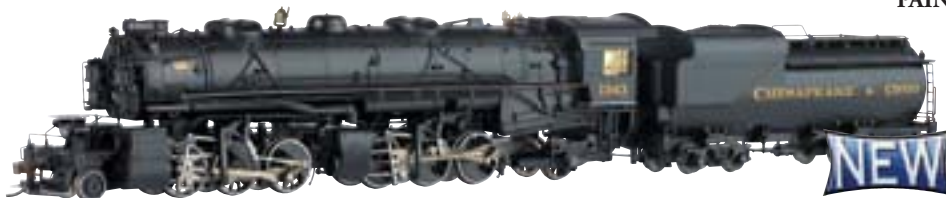

CHESAPEAKE & OHIO® H-4 #1343
Item No. 84812



CHESAPEAKE & OHIO® H-4 #1388
Item No. 84813



CHESAPEAKE & OHIO® H-4 #1432
Item No. 84814



ALL PRODUCTS ON THESE PAGES
EQUIPPED WITH BODY-MOUNTED
E-Z MATE® MARK II COUPLERS



CHESAPEAKE & OHIO® H-4 #1431
Item No. 84815

C&O H-4 2-6-6-2 Articulated Locomotive with Vandy VC12 Tender

Performs best on 22" radius curves or greater.

Standard Pack: 6 • \$415.00

The H-4 was the first engine in a series of over 200 locomotives employed by the C&O railroad which operated more 2-6-6-2 articulated locos than any other railroad in the world. These locomotives were often referred to as "vest pocket articulateds" because they were small yet very powerful.

Features include:

- DCC-equipped for speed, direction, and lighting
- dual-mode NMRA-compliant decoder with 8-pin plug
- die-cast boiler
- precision motor
- two flywheels
- geared drive
- electrical pickup on drivers
- operating LED headlight
- finescale metal detail parts, including metal cut levers and separately applied bell, whistle, domes and piping
- detailed cab interior with sliding windows
- RP25 wheel contours
- body-mounted NMRA coupler pockets
- *E-Z Mate*® Mark II couplers on front and rear

Tender features:

- C&O VC12 Vandy tender
- VC12 truck side frames
- easy decoder access
- detailed underframe with brake cylinder
- all-wheel electrical pickup
- hand-tooled coal load
- detailed coal boards
- metal handrails and finescale rivet detail



PAINTED, UNLETTERED - BLACK
Item No. 82621



CHESAPEAKE & OHIO® H-4 #1340
Item No. 82622



CHESAPEAKE & OHIO® H-4 #1397
Item No. 82623



CHESAPEAKE & OHIO® H-4 #1436
Item No. 82624



CHESAPEAKE & OHIO® H-4 #1439
Item No. 82625

USRA 2-6-6-2 Articulated Locomotive

Performs best on 18" radius curves or greater.

Standard Pack: 6 • \$575.00



One of many successful designs developed and standardized by the United States Railroad Administration, the *USRA 2-6-6-2 Articulated Steam Locomotive* was an impressive answer to industry's need for increased efficiency and productivity. With two independently swiveling driver and truck mechanisms, this limber giant's unique design allowed it to negotiate branchlines and tight curves while hauling larger consists than its smaller cousins in the USRA series. The popular design of this "drag engine" prompted manufacturers to produce similar locomotives well after the USRA returned control of locomotive production to the private railroad industry.

Features include:

- DCC sound-equipped
- die-cast boiler
- precision motor
- two flywheels
- geared drive
- electrical pickup on drivers
- operating headlight
- finescale metal detail parts, including metal cut levers and separately applied bell, whistle, domes, and piping
- detailed cab interior with sliding windows
- rust-colored, body-mounted NMRA coupler pockets

- RP25 wheel contours
- *E-Z Mate*® Mark II couplers on front and rear

Tender features:

- USRA long tender
- detailed underframe with brake cylinder
- all-wheel electrical pickup
- hand-tooled coal load
- geared drive
- detailed coal boards
- metal handrails and finescale rivet detail

Decoder features include:

- authentic sound effects uniquely appropriate to each model
- three whistles to choose from in each model
- real-time whistle for creating authentic signals
- high-quality 16-bit digital sound
- advanced motor control features, including load compensation and silent drive to provide smooth, quiet operation
- supports all recognized programming methods

USRA Light 2-10-2

Performs best on 22" radius curves or greater.

Standard Pack: 6 • \$450.00



Also known as Santa Fe class locomotives, these brutes were typically employed in drag freight service. Used throughout the United States until the late 1950s, our models are representative of the 2-10-2 as it appeared in the middle- to late-steam era.

Features include:

- DCC sound-equipped
- precision motor
- die-cast boiler
- die-cast frame
- die-cast cylinders
- Southern or Walschaerts valve gear per prototype
- tender style per prototype (with backup light)
- separately applied detail parts
- *E-Z Mate*® Mark II couplers



SOUTHERN #5216
Item No. 83802



SEABOARD® #2489
Item No. 83804

ALL PRODUCTS ON THESE PAGES
EQUIPPED WITH BODY-MOUNTED
E-Z MATE® MARK II COUPLERS



CHESAPEAKE & OHIO® H-5 #1519
Item No. 84802



CHESAPEAKE & OHIO® H-5 #1521
Item No. 84803



CHESAPEAKE & OHIO® H-5 #1523
Item No. 84804

USRA Light 2-10-2

Performs best on 22" radius curves or greater.

Standard Pack: 6 • \$250.00



Also known as Santa Fe class locomotives, these brutes were typically employed in drag freight service. Used throughout the United States until the late 1950s, our models are representative of the 2-10-2 as it appeared in the middle- to late-steam era.

Features include:

- DCC-equipped for speed, direction, and lighting
- precision motor
- die-cast boiler
- die-cast frame
- die-cast cylinders
- Southern or Walschaerts valve gear per prototype
- tender style per prototype (with backup light)
- separately applied detail parts
- E-Z Mate® Mark II couplers



CHICAGO & ILLINOIS MIDLAND #600
Item No. 83302



SEABOARD® #2485
Item No. 83310

CHICAGO & ILLINOIS MIDLAND #603
(not shown)
Item No. 83303

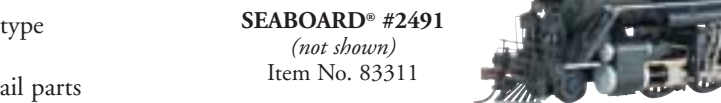

SEABOARD® #2491
(not shown)
Item No. 83311



KANSAS CITY SOUTHERN #220
Item No. 83312

KANSAS CITY SOUTHERN #223
(not shown)
Item No. 83313

Norfolk & Western Class J 4-8-4

Performs best on 22" radius curves or greater.

Standard Pack: 6 • \$425.00

The *Class J 4-8-4* was the last mainline steam locomotive to run in the United States. Designed for optimum speed, the "J" once reached 115 mph during a land test until a hesitant engineer closed the throttle.

Features include:

- DCC sound-equipped
- precision motor
- operating headlight
- separately applied metal parts
- alligator cross heads
- see-through frame
- RP25 wheel contours
- *E-Z Mate*® Mark II couplers



Decoder features include:

- authentic sound effects uniquely appropriate to each model
- three whistles to choose from in each model
- real-time whistle for creating authentic signals
- high-quality 16-bit digital sound
- advanced motor control features, including load compensation and silent drive to provide smooth, quiet operation
- supports all recognized programming methods



PASSENGER VERSION #606 (1950s)
Item No. 83902



PASSENGER VERSION #612 (1950s)
Item No. 83903



ALL PRODUCTS ON THESE PAGES
EQUIPPED WITH BODY-MOUNTED
E-Z MATE® MARK II COUPLERS



K4 4-6-2 Pacific

Performs best on 22" radius curves or greater.

Standard Pack: 6 • \$210.00

Built by the Pennsylvania Railroad in the early 20th century, the *K4 4-6-2 Pacific*s went through numerous modifications and improvements during their many years of service. The *Spectrum*® Pre-War K4 models, based on a World War I-era prototype, feature distinctive "chicken coop" slat pilots, while the Post-War versions are equipped with modern pilots.

DCCTM
ON BOARD

Features include:

- DCC-equipped for speed, direction, and lighting
- dual-mode NMRA-compliant decoder for DCC or DC operation
- operating headlight
- precision motor
- all-metal chassis
- blackened metal wheels and siderods
- RP25 wheel contours
- die-cast trailing truck
- painted engineer and fireman figures
- metal cut levers
- separately applied parts, including injectors, pump, and piping
- *E-Z Mate*® Mark II couplers front and rear

POST-WAR with MODERN PILOT

NEW

PENNSYLVANIA #3750
(not shown)
Item No. 84101

NEW

PENNSYLVANIA #1361
Item No. 84102



PRE-WAR with SLAT PILOT

NEW

PENNSYLVANIA #5448
Item No. 84103



2-10-0 Russian Decapod



Performs best on 22" radius curves or greater.

Standard Pack: 6 • \$375.00

With the advent of the Bolshevik Revolution in 1917, the Baldwin Locomotive Works was forced to stop shipment of more than one hundred 2-10-0 locomotives originally bound for Czarist Russia. These "orphan" locomotives later found homes with American railroad companies and helped relieve a scarcity of motive power following World War I. Faithful to detail, each roadname of this *Spectrum*® model has been customized per prototype.

Features include:

- DCC sound-equipped
- dual-mode NMRA-compliant decoder for DCC or DC operation
- operating headlight
- completely hidden drivetrain
- cog V-belt flywheel drive
- precision motor
- precision balanced brass flywheel
- metal motor bearings
- separately applied stack, domes, and cab
- metal detail parts, including bell, whistle, pop valves, cut levers, handrails, and stanchions
- separate sanding lines
- highly detailed cab interior
- painted crew figures
- siderods blackened per prototype
- rust-colored, magnetically operated *E-Z Mate*® knuckle couplers in front and rear
- die-cast, finescale driver spokes

Tender features:

- hand-tooled coal load
- detailed coal boards
- metal handrails
- detailed underframe
- all-wheel electrical pickup

Decoder features include:

- authentic sound effects uniquely appropriate to each model
- three whistles to choose from in each model
- real-time whistle for creating authentic signals
- high-quality 16-bit digital sound
- advanced motor control features, including load compensation and silent drive to provide smooth, quiet operation
- supports all recognized programming methods



PAINTED, UNLETTERED - BLACK
Item No. 84301



FRISCO with DOG HOUSE #1630
Item No. 84304



NASHVILLE, CHATTANOOGA & ST. LOUIS #952
with CAP STACK
Item No. 84305



SUSQUEHANNA #2443
Item No. 84306



ERIE #2464
Item No. 84307

Baldwin 4-6-0 Ten Wheeler

Performs best on 18" radius curves or greater.

Standard Pack: 6 • \$395.00

The 4-6-0 *Ten Wheeler* was a standard addition to most early 20th century railroads. Much like the 2-8-0 Consolidation, the 4-6-0 was a go-anywhere, do-anything locomotive that carried freight and passenger cars, and was also used for industrial applications. Our model replicates a "catalog standard" Baldwin locomotive built between 1905 and 1910, representing both 52-inch and 63-inch driver prototypes. The 4-6-0s were utilized throughout the steam era, with some locomotives seeing use in the American South as late as the 1950s.

Features include:

- DCC sound-equipped
- dual-mode NMRA-compliant decoder for DCC or DC operation
- precision motor
- 52-inch and 63-inch driver versions (per prototype)
- tender style varies with driver diameter
- all-metal Walschaerts valve gear
- operating headlight
- finescale metal detail parts including separately applied bell, whistle, domes, and piping
- detailed backhead
- painted crew figure
- RP25 wheel contours
- *E-Z Mate*® Mark II couplers on front and rear



ALL PRODUCTS ON THESE PAGES
EQUIPPED WITH BODY-MOUNTED
E-Z MATE® MARK II COUPLERS



MARYLAND & PENNSYLVANIA #28
(52" drivers)
Item No. 84905



SOUTHERN #1004
(52" drivers)
Item No. 84904



CHICAGO NORTHWESTERN #238
(63" drivers)
Item No. 84906



NEW YORK CENTRAL® #1233
(63" drivers)
Item No. 84907

Decoder features include:

- authentic sound effects uniquely appropriate to each model
- three whistles to choose from in each model
- real-time whistle for creating authentic signals
- high-quality 16-bit digital sound
- advanced motor control features, including load compensation and silent drive to provide smooth, quiet operation
- supports all recognized programming methods

SOUND ON BOARD

Baldwin Modern 4-4-0 Locomotive

Performs best on 15" radius curves or greater.

Standard Pack: 6 • \$475.00

Because it was the most widely employed wheel arrangement in this country from the 1880s through the end of the steam era, the 4-4-0 became known as the "American." The original ornate locomotives gave way to Americans with cleaner lines, such as these Baldwin "modern" models. Bachmann has taken the modern 4-4-0 to the next level with features such as an NMRA-compliant 8-pin decoder and Soundtraxx® Tsunami® sound technology that lets you enjoy every authentic whistle, bell, chuff, clang, and more in realistic high-quality 16-bit sound.

Features include:

- DCC sound-equipped
- dual-mode NMRA-compliant decoder with 8-pin plug
- cog V-belt drive
- die-cast boiler, chassis, and frame
- operating headlight
- finescale metal detail parts including separately applied bell, whistle, domes, and piping
- detailed backhead
- painted engineer and fireman figures
- RP25 wheel contours
- E-Z Mate® Mark II couplers on front and rear



PAINTED, UNLETTERED
(black with graphite smoke box and firebox)
Item No. 80126



LOUISVILLE & NASHVILLE #144
Item No. 80127



SOUTHERN #3858
(green & gold)
Item No. 80128



SEABOARD® #106
Item No. 80129



GREAT NORTHERN #124
(green & black)
Item No. 80130



204 **BALTIMORE & OHIO® #1401**
Item No. 80131

Decoder features include:

- authentic sound effects uniquely appropriate to each model
- three whistles to choose from in each model
- real-time whistle for creating authentic signals
- high-quality 16-bit digital sound
- advanced motor control features, including load compensation and silent drive to provide smooth, quiet operation
- supports all recognized programming methods



Baldwin Modern 4-4-0 Locomotive

Performs best on 15" radius curves or greater.

Standard Pack: 6 • \$325.00

Because it was the most widely employed wheel arrangement in this country from the 1880s through the end of the steam era, the 4-4-0 became known as the "American." The original ornate locomotives gave way to Americans with cleaner lines, such as these Baldwin "modern" models. Bachmann has taken the modern 4-4-0 to the next level with features such as an NMRA-compliant 8-pin decoder.

Features include:

- DCC-equipped for speed, direction, and lighting
- dual-mode NMRA-compliant decoder with 8-pin plug
- cog V-belt drive
- die-cast boiler, chassis, and frame
- operating headlight
- finescale metal detail parts including separately applied bell, whistle, domes, and piping
- detailed backhead
- painted engineer and fireman figures
- RP25 wheel contours
- E-Z Mate® Mark II couplers on front and rear



PAINTED, UNLETTERED
(black with graphite smoke box and firebox)
Item No. 80101



LOUISVILLE & NASHVILLE #7
Item No. 80102



SOUTHERN #3856
(green & gold)
Item No. 80103



SEABOARD® #108
Item No. 80104



GREAT NORTHERN #121
(green & black)
Item No. 80105



BALTIMORE & OHIO® #1400
Item No. 80106



ALL PRODUCTS ON THESE PAGES
EQUIPPED WITH BODY-MOUNTED
E-Z MATE® MARK II COUPLERS



DCC ON BOARD

Richmond 4-4-0 American - Modern

Performs best on 18" radius curves or greater.

Standard Pack: 6 • \$475.00



Before competition with Baldwin and other larger manufacturers forced the hands of smaller locomotive builders to merge and form Alco, the Richmond Locomotive Works offered this "state-of-the-art" 4-4-0 beginning in the early 1900s. Employed in main line and short mixed passenger service until as late as the mid-20th century, this thoroughly modern American was equipped with cutting-edge technology, such as air brakes, knuckle couplers, and a tapered boiler for improved steam efficiency.

Features include:

- DCC sound-equipped
- dual-mode NMRA-compliant decoder with 8-pin plug for DCC or DC operation
- precision motor
- die-cast boiler, chassis, and frame
- cog V-belt drive
- operating headlight
- all-metal Walschaerts valve gear
- finescale metal detail parts including separately applied bell, whistle, domes, and piping
- detailed backhead
- painted crew figure
- RP25 wheel contours
- E-Z Mate® Mark II couplers on front and rear



PAINTED, UNLETTERED with WOOD CAB
Item No. 85101



PAINTED, UNLETTERED with STEEL CAB
Item No. 85102



SOUTHERN #3854
Item No. 85103



MAINE CENTRAL #83
Item No. 85104



MARYLAND & PENNSYLVANIA #6
with STEEL CAB
Item No. 85105

Decoder features include:

- authentic sound effects uniquely appropriate to each model
- three whistles to choose from in each model
- real-time whistle for creating authentic signals
- high-quality 16-bit digital sound
- advanced motor control features, including load compensation and silent drive to provide smooth, quiet operation
- supports all recognized programming methods



ALL PRODUCTS ON THESE PAGES
EQUIPPED WITH BODY-MOUNTED
E-Z MATE® MARK II COUPLERS

Richmond 4-4-0 American - Modern

Performs best on 18" radius curves or greater.

Standard Pack: 6 • \$325.00

Before competition with Baldwin and other larger manufacturers forced the hands of smaller locomotive builders to merge and form Alco, the Richmond Locomotive Works offered this "state-of-the-art" 4-4-0 beginning in the early 1900s. Employed in main line and short mixed passenger service until as late as the mid-20th century, this thoroughly modern American was equipped with cutting-edge technology, such as air brakes, knuckle couplers, and a tapered boiler for improved steam efficiency.

Features include:

- DCC-equipped for speed, direction, and lighting
- dual-mode NMRA-compliant decoder with 8-pin plug
- precision motor
- die-cast boiler, chassis, and frame
- cog V-belt drive
- operating headlight
- all-metal Walschaerts valve gear
- finescale metal detail parts including separately applied bell, whistle, domes, and piping
- detailed backhead
- painted crew figure
- RP25 wheel contours
- E-Z Mate® Mark II couplers on front and rear

DCCTM
ON BOARD



MARYLAND & PENNSYLVANIA #4 with WOOD CAB
Item No. 83403



MARYLAND & PENNSYLVANIA #5 with WOOD CAB
Item No. 83404



MARYLAND & PENNSYLVANIA #6 with STEEL CAB
Item No. 83405



SOUTHERN
(green)
Item No. 83406



MAINE CENTRAL
Item No. 83407



SEABOARD®
Item No. 83408



RUSSIA IRON with WOOD CAB and PINSTRIPES
Item No. 83409





PAINTED, UNLETTERED - BLACK
Item No. 81811



SANTA FE #101
Item No. 81812



UNION PACIFIC® #88
Item No. 81813



MIDWEST QUARRY & MINING CO. #2
Item No. 81814



COLORADO MINING CO. #2
Item No. 81815



WEYERHAEUSER #5
Item No. 81816

0-6-0 Saddle Tank Switcher

Performs best on 15" radius curves or greater.

Standard Pack: 6 • \$135.00

A classic Alco locomotive perfect for a variety of industrial and yard switching applications, this 0-6-0 tank locomotive with fuel bunker excels at low-speed operation.

Features include:

- DCC-equipped for speed, direction, and lighting
- dual-mode NMRA-compliant decoder
- precision motor
- operating headlight
- hidden drive train
- low-speed gear box
- precision balanced brass flywheel
- metal motor bearings
- detailed cab interior
- metal detail parts, including bell, whistle, handrails, and stanchions
- painted crew figures
- blackened main and side rods
- rust-colored, magnetically operated *E-Z Mate*® couplers, front and rear



Spectrum DCC ON BOARD™



ALL PRODUCTS ON THESE PAGES
EQUIPPED WITH BODY-MOUNTED
E-Z MATE® MARK II COUPLERS

EMC Gas Electric Doodlebug Locomotive with Trailer Coach

Performs best on 22" radius curves or greater.

Standard Pack: 6 • \$225.00

The EMC Gas Electric, or "Doodlebug," as it would come to be known, was first manufactured during the Great Depression and provided extremely economical passenger service. In fact, the Doodlebugs kept railroads in the passenger business through World War II and into the 1960s.

Features include:

- DCC-equipped for speed, direction, and lighting
- dual-mode NMRA-compliant decoder
- precision can motor
- flywheel drive
- die-cast gear tower with bronze bearings
- die-cast gear box
- directional headlight
- constant interior lighting
- one-piece die-cast chassis
- Brill trucks
- operating baggage door
- *E-Z Mate*® Mark II couplers



Trailing car features:

- 72' coach with all new tooling
- LED constant lighting (analog and DCC operation)
- die-cast four-wheel Pullman trucks with all-wheel electrical pickup
- blackened metal wheels with RP25 contours
- *E-Z Mate*® Mark II couplers

PAINTED, UNLETTERED - PULLMAN GREEN
Item No. 81421

BALTIMORE & OHIO®
Item No. 81422

BOSTON & MAINE
Item No. 81423

MARYLAND & PENNSYLVANIA
Item No. 81424

SEABOARD®
Item No. 81425

NEW YORK CENTRAL®
Item No. 81426

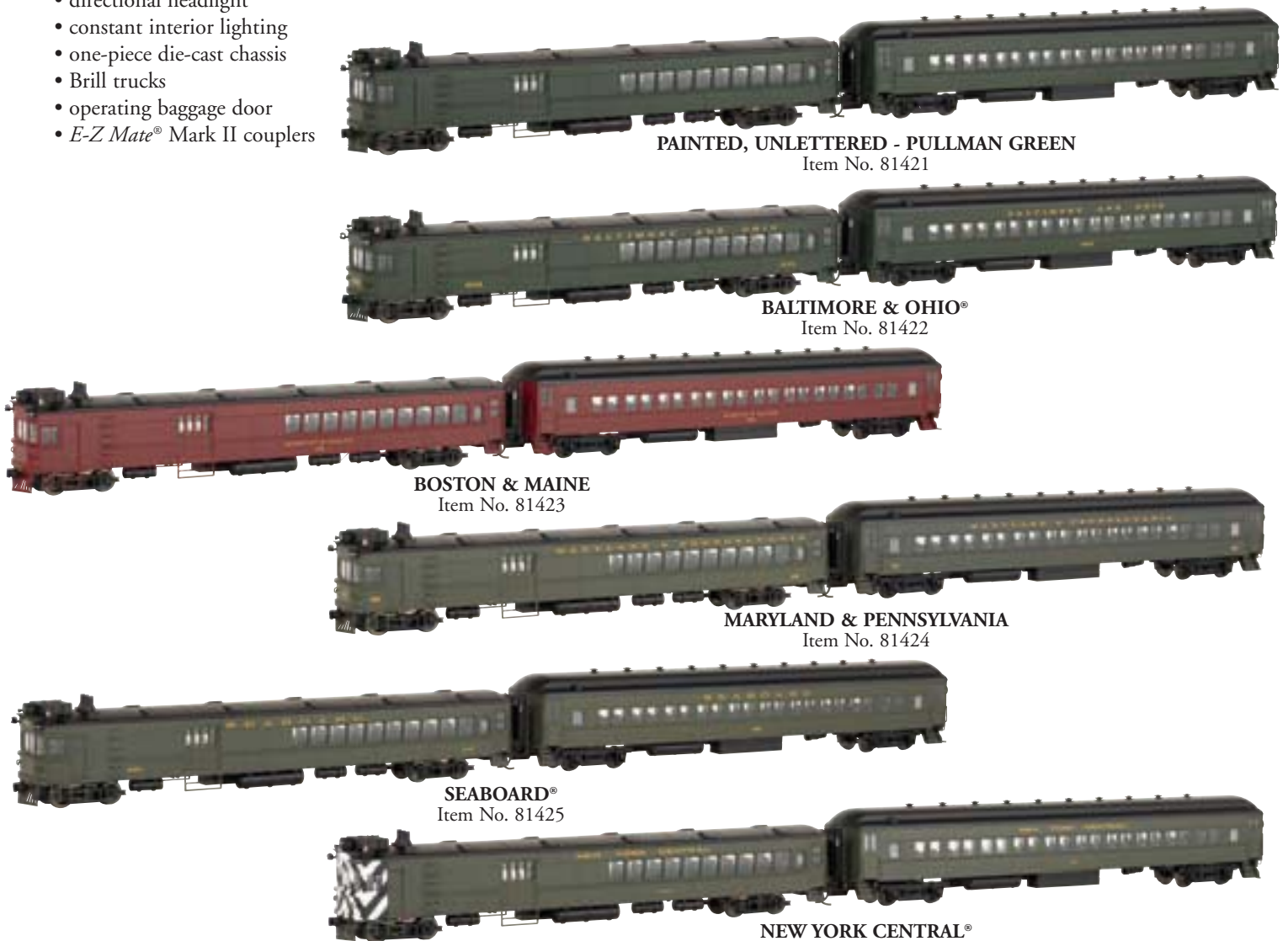

DCC ON BOARD
Spectrum

DCCTM ON BOARD



CONRAIL #6087
Item No. 83504



UNION PACIFIC® #9356
Item No. 83507

GE Dash 8-40CW

Performs best on 22" radius curves or greater.

Standard Pack: 6 • \$180.00

This wide-cab style locomotive was originally offered by General Electric as an option for the Dash 8-40C, later becoming the standard for their series of contemporary freight locomotives. We're proud to honor General Electric's high standards with our HO Scale *Spectrum*® Dash 8-40CW.

Features include:

- DCC equipped for speed, direction, and lighting
- dual-mode NMRA-compliant decoder
- die-cast frame
- precision motor
- machined brass flywheels
- directional lighting
- finescale detail parts
- RP25 wheel contours

DCCTM ON BOARD



ERIE LACKAWANNA #3610
Item No. 82720

EMD SD45

Performs best on 22" radius curves or greater.

Standard Pack: 6 • \$130.00

During the 60s and 70s, the race was on among locomotive manufacturers to develop more powerful locomotives for long-haul freight service. Among EMD's entrants into the fray was the "special duty" *SD45*, a 3600-horsepower prime mover that went on to serve virtually every major railroad. With a V-20 engine and six-axle trucks for superior tractive effort, the *SD45* embodied the latest and greatest technological advances of its day. Following EMD's lead in the pursuit of cutting-edge technology, we're proud to offer this *Spectrum*® locomotive.

Features include:

- DCC-equipped for speed, direction, and lighting
- dual-mode NMRA-compliant decoder
- die-cast gear towers
- die-cast mainframe
- die-cast underframe
- precision balanced motor and flywheel assembly for quiet operation
- brass, machined flywheels
- RP25 wheel contours



ALL PRODUCTS ON THESE PAGES
EQUIPPED WITH BODY-MOUNTED
E-Z MATE® MARK II COUPLERS



**PAINTED, UNLETTERED - YELLOW
with BLACK SAFETY STRIPES**
Item No. 85201



**PAINTED, UNLETTERED - BLACK
with YELLOW HANDRAILS**
Item No. 85202



**PAINTED, UNLETTERED - RED
with YELLOW HANDRAILS**
Item No. 85203



**BETHLEHEM STEEL - YELLOW
with SAFETY HANDRAILS**
Item No. 85205



U.S. ARMY
Item No. 85206



GE Center-Cab 45-Ton Switcher

Performs best on 9" radius curves or greater.

Standard Pack: 6 • \$140.00



Slow and steady wins the race where switchers are concerned. And with a top speed of 20 miles per hour, the early-phase center-cab 45-Tonner couldn't be beat. Used primarily in private industry and military applications during the 1940s, many GE 45-Tonners remain in service today, thanks to a simple and efficient design. Following GE's lead in creating sturdy and reliable switchers, our models will remain in service on your railroad for many years to come.

Features include:

- DCC-equipped for speed, direction, and lighting
- dual-mode NMRA-compliant decoder
- precision motor
- low-speed gearing
- eight-wheel drive
- die-cast chassis, side rods, and counterweights
- LED headlights
- E-Z Mate® Mark II couplers
- RP25 wheel contours
- painted engineer figure
- designed for aftermarket sound installation



**PAINTED, UNLETTERED - GREEN
with YELLOW HANDRAILS**
Item No. 85204



Peter Witt Streetcar

Performs best on 15" radius curves or greater.

Standard Pack: 6 • \$160.00



While serving as Cleveland's Street Railway Commissioner, Peter Witt designed an all-steel, single-operator streetcar that distinguished itself from others of the era by its use of the center door as an exit only. Passengers could pay the waiting motorman as they boarded at the front and exited at the center of the car, an arrangement that reduced stop times, improved schedules, and increased efficiency. Though designed originally for Cleveland, the *Peter Witt Streetcar* went on to service in cities throughout the world from the 1930s until the early 1960s.

Features include:

- DCC-equipped for speed, direction, and lighting
- dual-mode NMRA-compliant decoder with 8-pin plug for DCC or DC operation
- two-position switch (underside of car) for choice of overhead wire or track pickup
- all-wheel drive
- precision motor with two flywheels
- hidden drive train and electronics
- room for speaker
- die-cast frame and interior
- painted interior with seats
- photo-etched brass safety screen



CHICAGO SURFACE LINES
Item No. 84602



BALTIMORE TRANSIT CO.
Item No. 84604

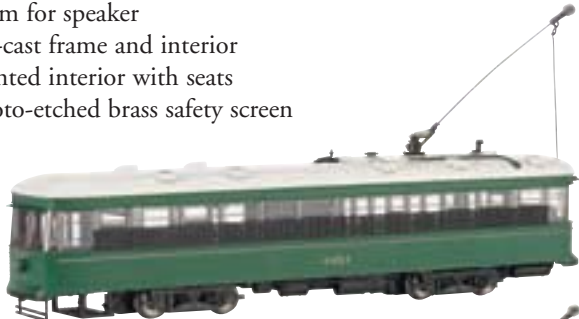

BROOKLYN & QUEENS TRANSIT
Item No. 84603



ST. LOUIS RAILWAYS
Item No. 84606



TORONTO
Item No. 84607



CLEVELAND TRANSIT
Item No. 84608



PHILADELPHIA
(not shown)
Item No. 84609



SAN FRANCISCO MUNICIPAL RAILWAY
(not shown)
Item No. 84610

DCC ON BOARD™ Spectrum

Single-Truck Birney Safety Streetcar

Performs best on 15" radius curves or greater.

Standard Pack: 6 • \$175.00

These small, light, steel streetcars were designed for one-man operation, which made them a boon to labor-strapped cities during World War I and economical to operate during the Great Depression. Originally called "Safety Cars" to emphasize that they were safe to ride, even without a conductor, they are better known as "Birneys" after their co-designer, Charles O. Birney.

Features include:

- DCC-equipped for speed, direction, and lighting
- designed for aftermarket sound system installation
- dual-mode NMRA-compliant decoder with 8-pin plug
- precision can motor
- finescale gearing for slow-speed operation
- working trolley poles
- all-wheel drive
- detailed painted interior
- LED lighting



PHILADELPHIA
Item No. 80201



BALTIMORE
Item No. 80202

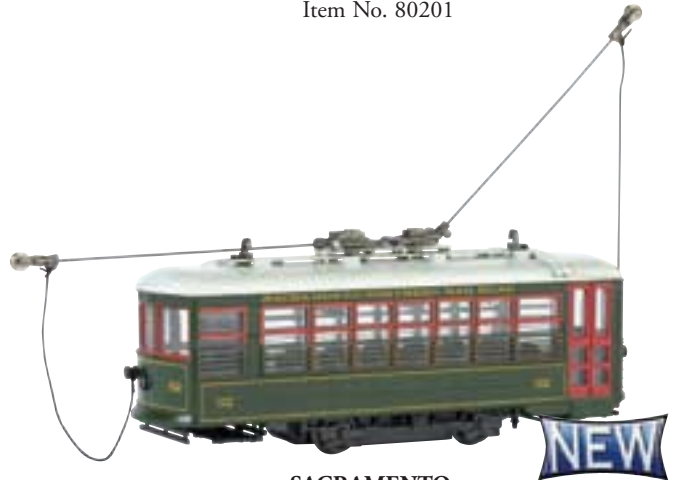

SACRAMENTO
Item No. 80203



NEW YORK & QUEENS
Item No. 80204



THIRD AVENUE RAILWAY SYSTEM
(NYC)
Item No. 80205





SPEEDER with WORK CRANE & CART
(couplers not included on front or rear)
Item No. 16946

Performs best on 15" radius curves or greater.

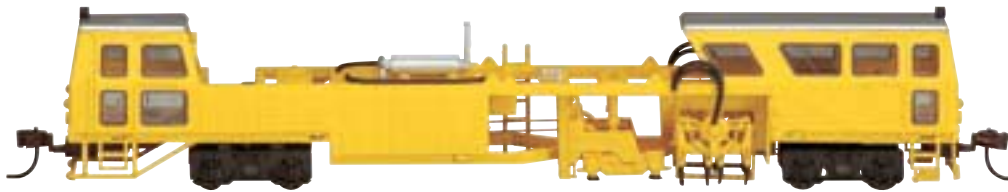

BALLAST REGULATOR
(DCC ready)
Item No. 16947

Performs best on 15" radius curves or greater.



BALLAST VEHICLE with CRANE
Item No. 16948

Performs best on 15" radius curves or greater.

Maintenance of Way Vehicles

Standard Pack: 6 • \$85.00

We're pleased to offer these self-propelled *Maintenance of Way* vehicles. A perfect addition to any post-steam railroad, the vehicles are available in standard safety yellow and are easily customizable.

Features include:

- self-propelled
- precision motor
- die-cast gravel load (per prototype)
- RP25 wheel contours



**ALL PRODUCTS ON THIS PAGE
EQUIPPED WITH BODY-MOUNTED
E-Z MATE® MARK II COUPLERS
(unless otherwise noted)**



Cityscenes™ Building Kits

The *Cityscenes*™ line of *Spectrum*® building kits offers a dramatic skyline for your diesel- or steam-era railroad. Two skyscrapers, a hotel, department store, variety store, bank, and bus station are all richly detailed and accurately modeled for amazing realism. Now your railroad can reach to the sky with Bachmann's *Cityscenes*™.



AMBASSADOR HOTEL
(10" W x 6 7/8" D x 10 1/2" H)
Item No. 88002 • Standard Pack: 3
\$99.00 each



METROPOLITAN BUILDING
(6" W x 8" D x 17 3/4" H)
Item No. 88003 • Standard Pack: 3
\$99.00 each



VARIETY STORE
(11 5/8" W x 7 1/2" D x 6 1/8" H)
Item No. 88004 • Standard Pack: 6
\$79.00 each



BUS STATION
(11 1/8" W x 7 1/4" D x 3" H)
Item No. 88005 • Standard Pack: 6
\$69.00 each



TRADE TOWER
(5 5/8" W x 7 5/8" D x 21 5/8" H)
Item No. 88007 • Standard Pack: 3
\$119.00 each

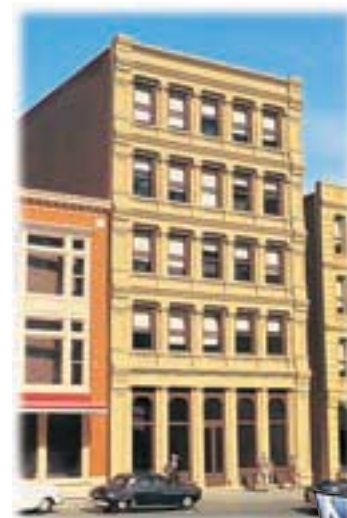

SAVINGS & LOAN
(5 1/4" W x 8 1/8" D x 10" H)
Item No. 88008 • Standard Pack: 6
\$79.00 each



DEPARTMENT STORE
(8 1/8" W x 6 1/8" D x 7 1/2" H)
Item No. 88006 • Standard Pack: 6
\$89.00 each



Note: Building dimensions are given as Width x Depth x Height. Measurements do not include building base, signage, fire escapes, overhangs, or ornamentation (if included with buildings). Previous modeling experience recommended.

N
SCALE

AMTRAK ACELA®

Acela Express®



Item No. 24130 • Standard Pack: 3 • \$500.00

The high-speed train that revolutionized prototypical rail travel comes to N scale in this DCC-equipped *Acela Express*® train set. Designed in cooperation with Amtrak, we've utilized the latest tooling technology to bring N scalers an exciting train for the modern-era layout.

The *Acela Express*® comes complete with:

- dual locomotives (non-powered) with DCC lighting functions
- center-powered Café *Acela*® Power Car DCC-equipped for speed, direction, and lighting
- one First-Class car and one Business car
- detailed, lighted interiors
- tinted windows
- 59" x 39" oval of nickel silver *E-Z Track*®, including 24 pieces of 19" radius curved track, 3 pieces straight track, and 1 plug-in terminal rerailer
- power pack and speed controller
- DVD-format video with assembly instructions



Acela Express® Locomotives and Power Car



Performs best on 19" radius curves or greater.

Standard Pack: 6

The *Acela Express*® locomotives and power car are offered individually in N scale. Note: N scale *Acela*® locomotives are non-powered units; powered Café *Acela*® car required for operation.

A typical Acela Express® train includes:
2 Locomotives, 1 First Class, 1 Café *Acela*®,
1 End-Business and 3 Business Class Cars.



ACELA® LOCOMOTIVES
(non-powered units with DCC lighting functions)
Item No. 81551 • \$125.00



CAFÉ ACELA® POWER CAR
(DCC-equipped; lighted interior)
Item No. 89971 • \$180.00



DCC ON BOARD



Amtrak HHP-8

Performs best on 19" radius curves or greater.

Standard Pack: 6 • \$200.00

Introduced to regional service in 2002, high horsepower (HHP-8) locomotives were built to extend the range of Amtrak's fleet of high-speed passenger trains. We're pleased to offer this sleek locomotive to modern-era N-scalers everywhere.

Features include:

- DCC-equipped for speed, direction, and lighting
- interior selector switch for choice between rail and pantograph operation
- precision motor
- 8-wheel drive
- die-cast chassis
- scale speed
- operating light functions



HHP-8 #650
Item No. 83054



HHP-8 #664
Item No. 83055





C&O H-4 2-6-6-2 Articulated Locomotive with Vandy VC12 Tender

Performs best on 11.25" radius curves or greater.

Standard Pack: 6 • \$310.00

The H-4 was the first engine in a series of over 200 locomotives employed by the C&O railroad which operated more 2-6-6-2 articulated locos than any other railroad in the world.

Features include:

- DCC-equipped for speed, direction, and lighting
- dual-mode NMRA-compliant decoder with 6-pin plug
- precision motor
- 12 wheel locomotive electrical pickup
- LED headlight including DCC dimming feature
- accurate details for C&O H-4 prototype locomotives
- separate detail parts, including bell, whistle, pop valves, and handrails
- NMRA wheel profile
- die-cast lead and trailing trucks

Tender features:

- C&O VC12 Vandy tender
- operating backup light
- metal cut levers
- body mounted coupler pocket
- easy access to decoder
- all-wheel electrical pickup



PAINTED, UNLETTERED - BLACK
Item No. 82671



CHESAPEAKE & OHIO® H-4 #1340
Item No. 82672



CHESAPEAKE & OHIO® H-4 #1397
Item No. 82673



CHESAPEAKE & OHIO® H-4 #1436
Item No. 82674



CHESAPEAKE & OHIO® H-4 #1439
Item No. 82675

DCC ON BOARD

Norfolk & Western Class J 4-8-4 Locomotive

Performs best on 11.25" radius curves or greater.

Standard Pack: 6

The Class J 4-8-4 was the last mainline steam locomotive to run in the United States. The popularity of our HO version of this model inspired us to offer this locomotive to N scale modelers.

Features include:

- DCC ready
- die-cast boiler, underframe, and tender frame
- precision motor
- separately applied detail parts and laser-cut exterior detailing
- die-cast finescale driver spokes
- dummy knuckle couplers, front and rear



NORFOLK & WESTERN CLASS J #611 (1950s - 60s)
Item No. 82153 • \$180.00



RAILFAN #611 with AUXILIARY TENDER (1980s - 90s)
Item No. 82154 • \$195.00



NORFOLK & WESTERN CLASS J #601 (1950s - 60s)
Item No. 82155 • \$180.00



USRA 4-8-2 Heavy Mountain

Performs best on 11.25" radius curves or greater.

Standard Pack: 6 • \$300.00

Built by Alco and Baldwin between 1918 and 1926, the *USRA 4-8-2 Heavy Mountain* steam locomotive was the faster, more powerful version of the USRA Light Mountain. Used for high speed passenger and freight service, the USRA Heavy Mountain's larger boiler helped power the locomotive over rough mountain terrain. We're pleased to offer models of this locomotive with prototypically accurate detail parts that make each roadname unique.

Features include:

- DCC-equipped for speed, direction, and lighting
- dual-mode NMRA-compliant decoder for DCC or DC operation
- 8-wheel locomotive pickup and all-wheel tender pickup
- LED headlight
- die-cast boiler
- die-cast split locomotive frame
- separate detail parts, including stanchions, pop valves and whistle
- body-mounted dummy knuckle couplers (compatible with other popular brands)
- NMRA wheel profile



PAINTED, UNLETTERED with VANDERBILT TENDER
(standard headlight)
Item No. 82511



PAINTED, UNLETTERED with USRA LONG TENDER
Item No. 82512



RIO GRANDE™ #1552 with USRA LONG TENDER
Item No. 82514



ILLINOIS CENTRAL #2981 with USRA LONG TENDER
Item No. 82515



NORFOLK & WESTERN #120 with USRA LONG TENDER
Item No. 82516



DCC ON BOARD



PAINTED, UNLETTERED - BLACK
Item No. 81651



UNION PACIFIC® #7012
Item No. 81661



NASHVILLE, CHATTANOOGA & ST. LOUIS® #555
Item No. 81662



NEW HAVEN #3303
Item No. 81663



NEW YORK, ONTARIO & WESTERN #404
Item No. 81665

USRA 4-8-2 Light Mountain

Performs best on 11.25" radius curves or greater.

Standard Pack: 6 • \$200.00

Inspired by our HO version of the model and equipped with many of the same details found on our award-winning N scale 2-8-0 Consolidation, we're moving mountains in N scale with this *Spectrum® USRA 4-8-2 Light Mountain*.

Features include:

- DCC ready
- precision motor
- metal motor and driver axle bearings
- operating headlight
- separately applied stack, domes, and cab
- completely hidden drive train
- gear drive
- metal tender wheels with pickup
- scale front-mounted dummy knuckle coupler (standard N scale coupler also packed separately)
- detailed cab interior
- separate sanding lines
- separate detail parts, including bell, whistle, pop valves, and handrails
- builder's plate
- die-cast, finescale driver spokes



Baldwin 2-8-0 Consolidation

Performs best on 11.25" radius curves or greater.

Standard Pack: 6 • \$220.00

In the tradition of our HO scale 2-8-0, this N scale *Consolidation* comes equipped with many of the same details found on its award-winning predecessor. Now for the first time it is available in this DCC-equipped version.

Features include:

- DCC-equipped for speed, direction, and lighting
- precision motor
- metal motor and driver axle bearings
- operating headlight
- separately applied stack, domes, and cab
- completely hidden drive train
- gear drive
- metal wheels under tender with pickup
- separate sanding lines
- separate detail parts, including bell, whistle, pop valves, and handrails
- builder's plate



UNION PACIFIC® #725
(black & silver)
Item No. 84551



WESTERN MARYLAND® #754 "FIREBALL"
Item No. 84552



SANTA FE #2514
Item No. 84553



CHESAPEAKE & OHIO® #705
Item No. 84554



DCC ON BOARD

Baldwin 2-8-0 Consolidation

Performs best on 11.25" radius curves or greater.

Standard Pack: 6 • \$180.00

In the tradition of our HO scale 2-8-0, this N scale *Consolidation* comes equipped with many of the same details found on its award-winning predecessor.

Features include:

- DCC ready
- precision motor
- metal motor and driver axle bearings
- operating headlight
- separately applied stack, domes, and cab
- completely hidden drive train
- gear drive
- metal wheels under tender with pickup
- separate sanding lines
- separate detail parts, including bell, whistle, pop valves, and handrails
- builder's plate



SEABOARD® #914
Item No. 81173

F7 A & B Units (both powered)

Performs best on 11.25" radius curves or greater.

Standard Pack: 6 • \$120.00

Built by General Motors in the early 1950s, the *F7* is one of the most recognizable locomotives of the diesel age. During its peak of popularity, the *F7* outsold all locomotives from all other builders combined! Often referred to as "covered wagons" or "bulldogs," this locomotive was used for all railroad operations, including first class passenger service. Run throughout North America, many *F7*s are still in use today.

Features include:

- precision motor (both A & B units)
- pillow block bearings in gear towers
- operating headlight in A-unit
- teardrop windows
- die-cast chassis
- all-wheel pickup
- NMRA wheel profile



NEW YORK CENTRAL® #1723, #2448
Item No. 81261



PENNSYLVANIA #9652, #9667B
Item No. 81262



SOUTHERN PACIFIC™ #6443, #8292 "BLACK WIDOW"
Item No. 81263





UNION PACIFIC® #9218
Item No. 85053



NORFOLK SOUTHERN #8654
Item No. 85055



CSX® #7592
Item No. 85059



CONRAIL #6025
Item No. 85072

GE Dash 8-40C

Performs best on 11.25" radius curves or greater.

Standard Pack: 6 • \$150.00

Developed in the early 1980s, the *Dash 8-40C* embodied General Electric's desire to take the lead in modern locomotive design, with the first mass-produced, 4000-horsepower locomotive. The *Dash 8-40C* employed the day's state-of-the-art computer and mechanical technology to earn its reputation for fast and reliable service on railroads throughout the United States. Incorporating today's cutting-edge model railroading technology, we're pleased to offer this premium *Spectrum*® locomotive.

Features include:

- DCC ready
- two piece die-cast main frame
- all-wheel pickup
- precision motor
- dual machined brass flywheels
- white LED lighting
- finescale detail parts
- NMRA wheel profile



READING "BEE LINE" #7606
Item No. 82759



CONRAIL #6146
Item No. 82762

EMD SD45

Performs best on 11.25" radius curves or greater.

Standard Pack: 6 • \$100.00

During the 60s and 70s, the race was on among locomotive manufacturers to develop more powerful locomotives for long-haul freight service. Among EMD's entrants into the fray was the "special duty" *SD45*, a 3600-horsepower prime mover that went on to serve virtually every major railroad. With a V-20 engine and six-axle trucks for superior tractive effort, the *SD45* embodied the latest technological advances of its day. Following EMD's lead in the pursuit of cutting-edge technology, we're proud to offer this *Spectrum*® locomotive.

Features include:

- DCC ready
- two-piece die-cast main frame
- all-wheel pickup
- precision motor
- dual machined brass flywheels
- white LED lighting
- finescale detail parts
- NMRA wheel profile



GE 44-Ton Switcher



Performs best on 9" radius curves or greater.

Standard Pack: 6 • \$115.00

Following in the footsteps of the HO engine that marked the beginning of our *Spectrum*® line more than 20 years ago, we're pleased to again raise the bar for N scale model railroading with this locomotive. Technology has finally caught up with our vision of what an N scale 44-Tonner should be, allowing us to bring you this exceptionally detailed DCC-equipped model.

Features include:

- DCC-equipped for speed, direction, and lighting
- dual-mode NMRA-compliant decoder
- eight-wheel drive
- precision motor
- LED headlights
- scale 33" wheels with NMRA wheel profile
- non-operating dummy knuckle couplers

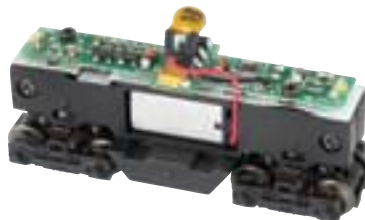

PAINTED, UNLETTERED - YELLOW
Item No. 81851



PAINTED, UNLETTERED - RED & YELLOW
Item No. 81852



PENNSYLVANIA
Item No. 81853



NEW HAVEN
Item No. 81855



BALTIMORE & OHIO®
Item No. 81854



BOSTON & MAINE
(Minuteman)
Item No. 81857



DENVER & RIO GRANDE WESTERN™
Item No. 81858



U.S. ARMY
Item No. 81859

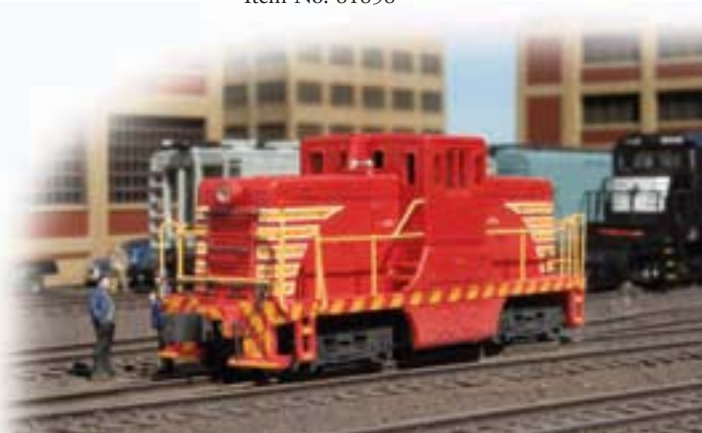

DCC ON BOARD

GE 70-Ton Diesel

Performs best on 7" radius curves or greater.

Standard Pack: 6 • \$125.00 each

Promoted as “middleweight power with a heavyweight punch,” the *GE 70-Ton Diesel* was an economical and efficient choice for branchline, short line, and industrial switching duties. For the first time, this champ has all its power packed into an N scale version.

Features include:

- DCC-equipped for speed, direction, and lighting
- dual-mode NMRA-compliant decoder
- 8-wheel drive
- precision can motor
- die-cast chassis
- front and rear metal cut levers
- NMRA wheel profile
- *E-Z Mate*® Mark II couplers



PAINTED, UNLETTERED - BLACK
Item No. 82051



PAINTED, UNLETTERED - RED
Item No. 82052



PAINTED, UNLETTERED - GREEN
Item No. 82053



PAINTED, UNLETTERED - YELLOW & BLACK
Item No. 82054



SOUTHERN PACIFIC™ #5101
(gray & red)
Item No. 82055



LOUISVILLE & NASHVILLE® #98
(black & yellow)
Item No. 82056



BETHLEHEM STEEL
(yellow & black)
Item No. 82057

Spectrum DCC ON BOARD

Peter Witt Streetcar

Performs best on 9" radius curves or greater.

Standard Pack: 6 • \$150.00 each

This distinctive streetcar with its innovative exit-only center door is being offered for the first time in N scale and boasts superfine detailing and realistic LED headlights and backup lights.

Features include:

- DCC-equipped for speed, direction, and lighting
- dual-mode NMRA-compliant decoder
- eight-wheel drive
- precision can motor
- LED headlights and backup lights
- hidden drive train and electronics
- photo-etched brass safety screen

DCCTM
ON BOARD



TORONTO
Item No. 84651



CHICAGO SURFACE LINES
Item No. 84652



BROOKLYN & QUEENS TRANSIT
Item No. 84653



BALTIMORE TRANSIT CO.
Item No. 84654



LOS ANGELES RAILWAY
Item No. 84655



ST. LOUIS RAILWAYS
Item No. 84656

Chesapeake & Ohio® Vanderbilt Tender

Standard Pack: 6 • \$42.00

Designed to carry a greater capacity than its typical contemporaries, the Vanderbilt tender was used by railroads across the country.

Features include:

- DCC ready
- backup light (where applicable)
- die-cast frame
- drawbar compatible with many popular brands
- RP25 wheel contours



GREAT NORTHERN
Item No. 89453

USRA Short Tender

Standard Pack: 6 • \$46.00

Features include:

- DCC ready
- die-cast frame
- drawbar compatible with many popular brands
- RP25 wheel contours



PAINTED, UNLETTERED
Item No. 89551



BALTIMORE & OHIO®
Item No. 89552



UNION PACIFIC®
Item No. 89553



SOUTHERN PACIFIC™
Item No. 89554

USRA Medium Tender

Standard Pack: 6 • \$46.00

Features include:

- DCC ready
- die-cast frame
- drawbar compatible with many popular brands
- RP25 wheel contours



PAINTED, UNLETTERED
Item No. 89751



WESTERN MARYLAND "FIREBALL"
Item No. 89752



BALTIMORE & OHIO®
Item No. 89753



MAINE CENTRAL
Item No. 89754



NEW HAVEN
Item No. 89454



Have a question? You can
"Ask the Bach-Man" on
our message board at
[www.bachmanntrains.com!](http://www.bachmanntrains.com)

USRA Long Tender

Standard Pack: 6 • \$42.00

Features include:

- DCC ready
- die-cast frame
- drawbar compatible with many popular brands
- RP25 wheel contours



CHESAPEAKE & OHIO®
Item No. 89852



NICKEL PLATE
Item No. 89853



RIO GRANDE™
(Flying Grande)
Item No. 89854

USRA Slope Back Tender

Standard Pack: 6 • \$46.00

Features include:

- all new tooling
- die-cast frame
- drawbar compatible with many popular brands
- RP25 wheel contours



PAINTED, UNLETTERED
Item No. 89651



NEW YORK CENTRAL®
Item No. 89652



PENNSYLVANIA
Item No. 89653



BALTIMORE & OHIO®
Item No. 89654

Home for the Holidays



an E-Z Track® set with E-Z Mate® couplers

Item No. 25021 • Standard Pack: 3 • \$375.00

Welcoming family and friends to share the holidays is one of life's most cherished pleasures. This festively decorated ready-to-run train set carries passengers ever closer to home as it travels around your Christmas tree or holiday layout. *Home for the Holidays* comes complete with a 2-6-0 steam locomotive with operating headlight and coal tender, three lighted passenger cars, 56" x 38" oval of nickel silver *E-Z Track*®, magnetically operated *E-Z Mate*® couplers on all cars, power pack and speed controller, and helpful DVD video with assembly instructions.



Santa's Express

an E-Z Track® set with E-Z Mate® couplers

Item No. 25019 • Standard Pack: 3 • \$365.00

The crisp sound of a distant train whistle can be heard drifting on the frosty winter winds. *Santa's Express* is making its trek from the North Pole with a delivery of holiday cheer for children everywhere! *Santa's Express* includes a 2-6-0 steam locomotive with operating headlight and coal tender, combine with lighted interior, coal hopper, gondola, 56" x 38" oval of nickel silver *E-Z Track*®, magnetically operated *E-Z Mate*® couplers on all cars, power pack and speed controller, and helpful DVD video with assembly instructions.



Spectrum

ELECTRIC TRAIN SETS

On30
SCALE

56" x 38"
Oval

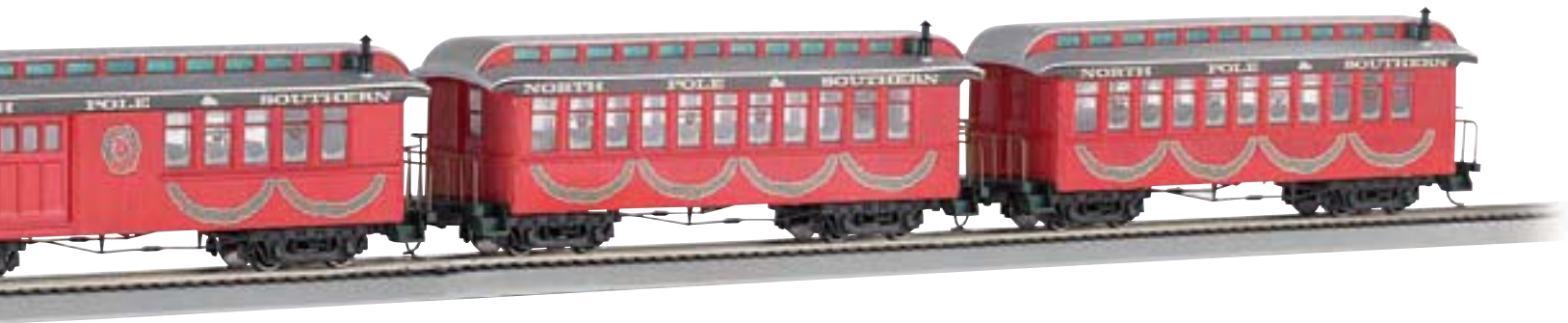

56" x 38"
Oval



Rocky Mountain Express

an E-Z Track® set with E-Z Mate® couplers



Item No. 25020 • Standard Pack: 3 • \$395.00

Incorporated in 1898, the Colorado and Southern would acquire several smaller railroads to operate in Colorado along four narrow gauge lines until highways were built that could access the rugged terrain. Our *Rocky Mountain Express* set recalls the C&S trains that climbed the scenic Colorado peaks as the essential haulers for historic towns such as Black Hawk, Silver Plume, and Gunnison. This ready-to-run train set includes a 2-6-0 locomotive with operating headlight and coal tender, gondola, reefer, tank car, caboose, 56" x 38" oval of nickel silver *E-Z Track®*, magnetically operated *E-Z Mate®* couplers on all cars, power pack and speed controller, and helpful DVD video with assembly instructions.



Village Street Car Set

with electronic auto-reversing nickel silver E-Z Track®

Standard Pack: 3 • \$205.00

Our Village Street Car Set features an electronic auto-reversing *E-Z Track®* system that's the perfect solution for point-to-point passenger transit on your layout. A stop time of five to seven seconds allows plenty of time for O scale shoppers and travelers to board, and a variable speed controller lets you determine the rate of travel. Then, sit back and enjoy the ride while your town or city comes to life!

Features include:

- street car with headlights and lighted interior
- variable speed control
- 4 pieces of 18" radius curved, auto-reversing *E-Z Track®*
- 3 pieces of 9" straight, auto-reversing *E-Z Track®*
- 1 piece of straight *E-Z Track®* with attached station house
- 1 Hayes bumper
- illustrated instruction manual



CHRISTMAS
Item No. 25017



**ELECTRONIC AUTO-REVERSING
NICKEL SILVER E-Z TRACK®**

Standard Pack: 12 • \$34.00 each

You can expand your auto-reversing train set or track system with Electronic Auto-Reversing Nickel Silver E-Z Track® sections. Available in 9-inch straight or 18-inch radius curved sections, this electronically equipped track is specifically designed for the open-end track configuration of our auto-reversing track system, allowing you to go virtually anywhere in your layout.



AUTO-REVERSING 9" STRAIGHT
(4 per card)
Item No. 44548

Note: this track will not operate as reversing track unless it is used in conjunction with train set numbers 00401, 00402, 25016, 25017, or with our auto-reversing track system, Item No. 44547



AUTO-REVERSING 18" RADIUS CURVED
(4 per card)
Item No. 44549

ON30 — O SCALE NARROW GAUGE TRAINS THAT RUN ON HO TRACK

Porter 0-4-2 Steam Locomotive

Performs best on 18" radius curves or greater.

Standard Pack: 6 • \$275.00 each

The 0-4-2's larger fuel bunker and trailing truck allowed it to travel longer distances than its "little brother," the Porter 0-4-0. They were put to work on plantation, logging, and construction roads. Bachmann is pleased to reintroduce this popular narrow gauge steam locomotive with many new features, including an NMRA-compliant decoder and *Soundtraxx® Tsunami®* sound technology so you can enjoy every authentic whistle, bell, chuff, and much more in realistic high-quality 16-bit sound.

Features include:

- DCC sound-equipped
- dual-mode NMRA-compliant decoder
- precision can motor
- operating LED headlight
- die-cast boiler and frame
- completely hidden drive train
- gear drive
- separate metal detail parts, including bell, whistle, and handrail
- separate Porter Company builder's plate
- detailed cab interior
- die-cast finescale drivers
- brass valve guides
- *E-Z Mate®* Mark II couplers



Decoder features include:

- authentic sound effects uniquely appropriate to each model
- three whistles to choose from in each model
- real-time whistle for creating authentic signals
- high-quality 16-bit digital sound
- advanced motor control features, including load compensation and silent drive to provide smooth, quiet operation
- supports all recognized programming methods



PAINTED, UNLETTERED - MAROON
(image for illustration only; final product may vary)
Item No. 28201



**PAINTED, UNLETTERED - BLACK
with MAROON & GOLD**
(image for illustration only; final product may vary)
Item No. 28202



**PAINTED, UNLETTERED - BLACK
with WHITE PINSTripES**
(image for illustration only; final product may vary)
Item No. 28203



TIOGA LUMBER CO. #3
Item No. 28204



CLEAR LAKE LUMBER CO. #2
(not shown)
Item No. 28205



**ALL PRODUCTS ON THESE PAGES
EQUIPPED WITH BODY-MOUNTED
E-Z MATE® MARK II COUPLERS**

Porter 0-4-2 Steam Locomotive



Performs best on 18" radius curves or greater.

Standard Pack: 6 • \$150.00 each

The 0-4-2's larger fuel bunker and trailing truck allowed it to travel longer distances than its "little brother," the Porter 0-4-0. They were put to work on plantation, logging, and construction roads. Bachmann is pleased to reintroduce this popular narrow gauge steam locomotive with many new features, including an NMRA-compliant decoder.

Features include:

- DCC-equipped for speed, direction, and lighting
- dual-mode NMRA-compliant decoder
- precision can motor
- operating LED headlight
- die-cast boiler and frame
- completely hidden drive train
- gear drive
- separate metal detail parts, including bell, whistle, and handrail
- separate Porter Company builder's plate
- detailed cab interior
- die-cast finescale drivers
- brass valve guides
- E-Z Mate® Mark II couplers



GREENBRIER & BIG RUN LUMBER CO.
Item No. 28257



TIOGA LUMBER CO. #2
Item No. 28259



PAINTED, UNLETTERED - MAROON
(image for illustration only; final product may vary)
Item No. 28260



**PAINTED, UNLETTERED - BLACK
with MAROON & GOLD**
(image for illustration only; final product may vary)
Item No. 28261

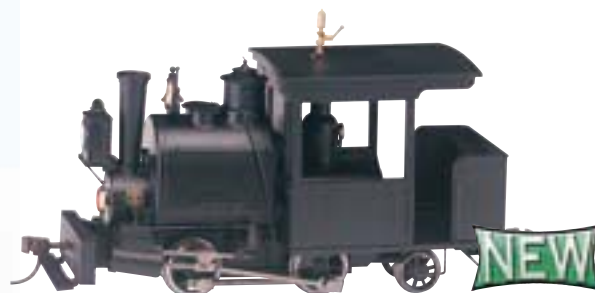
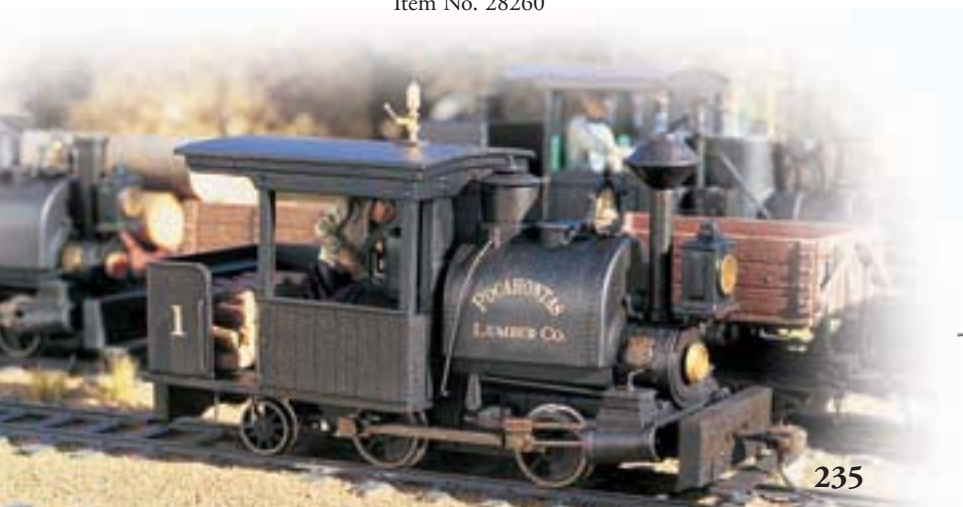

PAINTED, UNLETTERED - BLACK
Item No. 28299

**Porter 0-4-0
Steam Locomotive**

Performs best on 18" radius curves or greater.

Standard Pack: 6 • \$275.00 each

With a simple, compact design perfectly suited for sharp curves and rough track, the prototype of this 8-ton "teapot with character" hissed and puffed its way through the light branchlines and industrial railroads of the steam era. Bachmann is pleased to reintroduce this popular narrow gauge steam locomotive with many new features, including an NMRA-compliant decoder and Soundtraxx® Tsunami® sound technology that allows you to enjoy every authentic whistle, bell, chuff, and much more in realistic high-quality 16-bit sound.

Features include:

- DCC sound-equipped
- dual-mode NMRA-compliant decoder
- precision can motor
- constant lighting LED headlight
- operating cab windows
- die-cast boiler and frame
- completely hidden drive train
- gear drive
- separate metal detail parts, including bell, whistle, and handrail
- separate Porter Company builder's plate
- detailed cab interior with coal bunker
- die-cast finescale drivers
- brass valve guides
- *E-Z Mate*® Mark II couplers

Decoder features include:

- authentic sound effects uniquely appropriate to each model
- three whistles to choose from in each model
- real-time whistle for creating authentic signals
- high-quality 16-bit digital sound
- advanced motor control features, including load compensation and silent drive to provide smooth, quiet operation
- supports all recognized programming methods



**PAINTED, UNLETTERED
with VERTICAL CAB PANEL**
Item No. 28058



**PAINTED, UNLETTERED
with HORIZONTAL CAB PANEL**
Item No. 28059

**Porter 0-4-0
Steam Locomotive**

Performs best on 18" radius curves or greater.

Standard Pack: 6 • \$150.00

With a simple, compact design perfectly suited for sharp curves and rough track, the prototype of this 8-ton "teapot with character" hissed and puffed its way through the light branchlines and industrial railroads of the steam era. Bachmann is pleased to reintroduce this popular narrow gauge locomotive with many new features, including an NMRA-compliant decoder.

Features include:

- DCC-equipped for speed, direction, and lighting
- dual-mode NMRA-compliant decoder
- precision can motor
- constant lighting LED headlight
- operating cab windows
- die-cast boiler and frame
- completely hidden drive train
- gear drive
- separate metal detail parts, including bell, whistle, and handrail
- separate Porter Company builder's plate
- detailed cab interior with coal bunker
- die-cast finescale drivers
- brass valve guides
- *E-Z Mate*® Mark II couplers



**PAINTED, UNLETTERED
with VERTICAL CAB PANEL**
Item No. 28098



**PAINTED, UNLETTERED
with HORIZONTAL CAB PANEL**
Item No. 28099

28-Ton Two-Truck Climax

Performs best on 18" radius curves or greater.

Standard Pack: 6 • \$499.00

In the late 1800s, the Climax Locomotive Works paved the way for geared locomotive development with innovative designs and improvements to existing technology. One such offering was the *28-Ton Two-Truck Climax*. With a horizontal boiler, this version of the Class B Climax offered more power and efficiency than its T-boiler predecessors. The successful 28-Tonner was produced until 1904 and continued in scattered service into the early 1950s.

Features include:

- DCC sound-equipped
- dual-mode NMRA-compliant decoder for DCC or DC operation
- precision motor
- prototypical center gearbox distributes power to two truck gearboxes
- three cab styles per prototype (double-panel wood; single-panel wood; or steel cab with modern headlights, generator, and air pump)
- die-cast frame, cab, and boiler
- wood, coal, and oil load included with all roadnames



PAINTED, UNLETTERED - SINGLE PANEL WOOD CAB
(black with red & white trim)
Item No. 28601



PAINTED, UNLETTERED - STEEL CAB
(black with red & white trim)
Item No. 28602

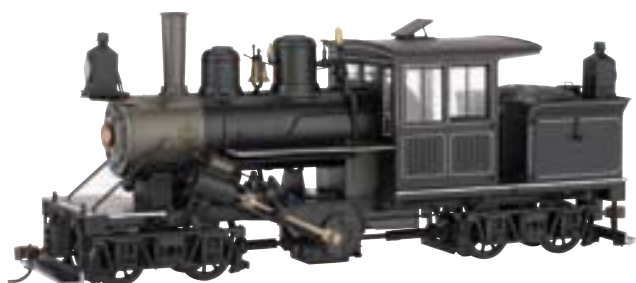

PAINTED, UNLETTERED - TWO PANEL WOOD CAB
(black with white trim)
Item No. 28603



PAINTED, UNLETTERED - STEEL CAB
(black)
Item No. 28604



PAINTED, UNLETTERED - SINGLE PANEL WOOD CAB
(black)
Item No. 28605

Decoder features include:

- authentic sound effects uniquely appropriate to each model
- three whistles to choose from in each model
- real-time whistle for creating authentic signals
- high quality 16-bit digital sound
- advanced motor control features, including load compensation and silent drive to provide smooth, quiet operation
- supports all recognized programming methods



**ALL PRODUCTS ON THESE PAGES
EQUIPPED WITH BODY-MOUNTED
E-Z MATE® MARK II COUPLERS**

SOUND ON BOARD

T-Boiler Two-Truck Shay

Performs best on 18" radius curves or greater.

Standard Pack: 6 • \$499.00



Our *T-Boiler, Two-Truck Shay* steam locomotive is inspired by the 14-ton locomotives commonly used on late 19th to mid-20th century logging railroads. Showing "backwoods ingenuity," these Shays were often customized to meet the needs of individual railroads. Each version of our On30 Shay has many features unique per roadname.

Features include:

- DCC sound-equipped
- die-cast construction
- metal valve gear
- precision motor
- operating headlight
- separate metal detail parts
- three cab styles (sheet metal, vertical wood, or raised wood panel per prototype)
- *E-Z Mate*® Mark II couplers, front and rear



PAINTED, UNLETTERED - WOOD CAB

(black)

Item No. 28501

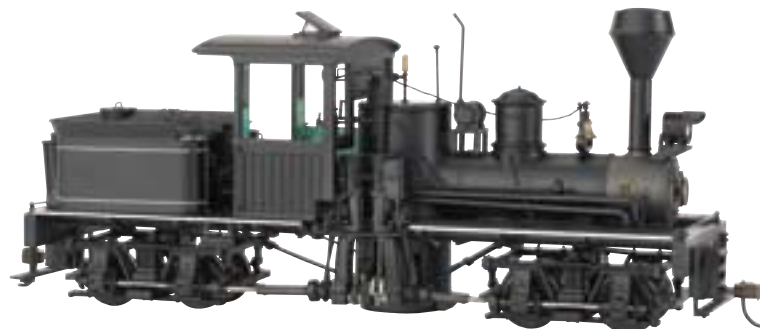

PAINTED, UNLETTERED - WOOD CAB

(black with white pinstripes)

Item No. 28502



PAINTED, UNLETTERED - TWO PANEL WOOD CAB

(black)

Item No. 28503



PAINTED, UNLETTERED - STEEL CAB

(black with white pinstripes)

Item No. 28504

Decoder features include:

- authentic sound effects uniquely appropriate to each model
- three whistles to choose from in each model
- real-time whistle for creating authentic signals
- high-quality 16-bit digital sound
- advanced motor control features, including load compensation and silent drive to provide smooth, quiet operation
- supports all recognized programming methods



**ALL PRODUCTS ON THESE PAGES
EQUIPPED WITH BODY-MOUNTED
E-Z MATE® MARK II COUPLERS**

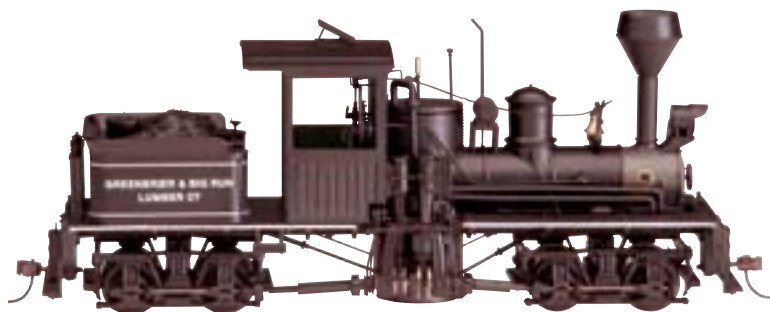

GREENBRIER & BIG RUN LUMBER CO.
Item No. 25657

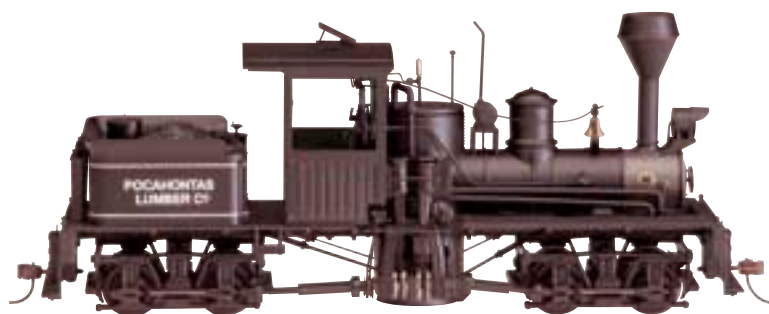

POCAHONTAS LUMBER CO.
Item No. 25660

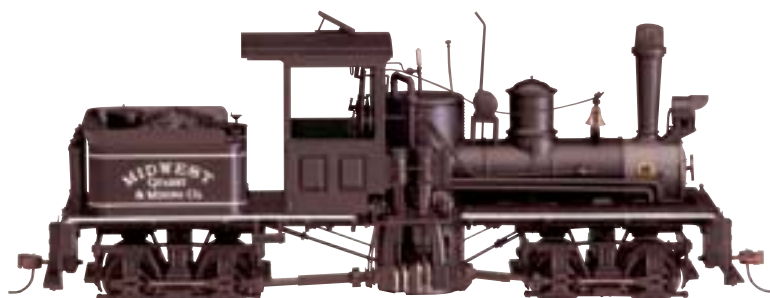

MIDWEST QUARRY & MINING CO.
Item No. 25661

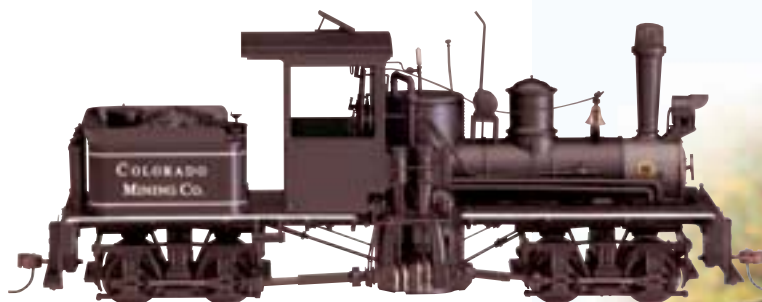

COLORADO MINING CO.
Item No. 25662

T-Boiler Two-Truck Shay

Performs best on 18" radius curves or greater.

Standard Pack: 6 • \$325.00

Our *T-Boiler, Two-Truck Shay* steam locomotive is inspired by the 14-ton locomotives commonly used on late 19th to mid-20th century logging railroads. Showing “backwoods ingenuity,” these Shays were often customized to meet the needs of individual railroads. Each version of our On30 Shay has many features unique per roadname.

Features include:

- DCC ready
- die-cast construction
- metal valve gear
- precision motor
- operating headlight
- separate metal detail parts
- three cab styles (sheet metal, vertical wood, or raised wood panel per prototype)
- *E-Z Mate*® Mark II couplers, front and rear



2-6-6-2 Articulated Locomotive with Tender



Performs best on 18" radius curves or greater.

Standard Pack: 6 • \$575.00

Our On30 2-6-6-2 is the first accurately scaled and detailed model of an articulated engine in this scale. It is based on a 30-inch Baldwin Locomotive Works design and includes many optional parts so you can customize the locomotive to suit your own layout.

Locomotive features include:

- DCC sound-equipped
- dual-mode NMRA-compliant decoder with 8-pin plug
- dual flywheel drive
- die-cast twin idler gear boxes
- operates on 18" radius curves
- detailed cab with sliding windows
- detailed backhead with seat boxes
- E-Z Mate® Mark II couplers

Tender features include:

- operating LED backup light
- easy access to decoder
- die-cast underframe
- accurate long wheel base per prototype



GREENBRIER & BIG RUN LUMBER CO. #42
Item No. 28703



POCAHONTAS LUMBER CO. #40
Item No. 28704



MIDWEST QUARRY & MINING CO. #44
Item No. 28705



COLORADO MINING CO. #48
Item No. 28706

Decoder features include:

- authentic sound effects uniquely appropriate to each model
- three whistles to choose from in each model
- real-time whistle for creating authentic signals
- high quality 16-bit digital sound
- advanced motor control features, including load compensation and silent drive to provide smooth, quiet operation
- supports all recognized programming methods

2-6-6-2 Articulated Locomotive with Tender

Performs best on 18" radius curves or greater.

Standard Pack: 6 • \$425.00

Our On30 2-6-6-2 is the first accurately scaled and detailed model of an articulated engine in this scale. It is based on a 30-inch Baldwin Locomotive Works design and includes many optional parts so you can customize the locomotive to suit your own layout.

Locomotive features include:

- DCC-equipped for speed, direction and lighting
- dual-mode NMRA-compliant decoder with 8-pin plug
- dual flywheel drive
- die-cast twin idler gear boxes
- operates on 18" radius curves
- detailed cab with sliding windows
- detailed backhead with seat boxes
- E-Z Mate® Mark II couplers

Tender features include:

- operating LED backup light
- easy access to decoder
- die-cast underframe
- accurate long wheel base per prototype



GREENBRIER & BIG RUN LUMBER CO. #41
Item No. 28757



POCAHONTAS LUMBER CO. #42
Item No. 28760



MIDWEST QUARRY & MINING CO. #43
Item No. 28761



COLORADO MINING CO. #46
Item No. 28762



PAINTED, UNLETTERED - BLACK with RED & WHITE TRIM
Item No. 28798

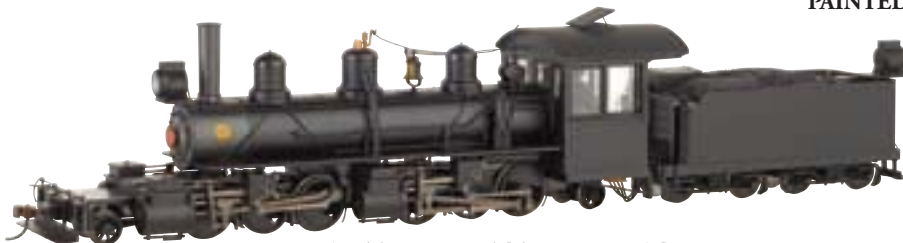

PAINTED, UNLETTERED - BLACK
Item No. 28799



ALL PRODUCTS ON THESE PAGES
EQUIPPED WITH BODY-MOUNTED
E-Z MATE® MARK II COUPLERS

SOUND ON BOARD™

Baldwin Forney 2-4-4 Steam Locomotive

Performs best on 18" radius curves or greater.

Standard Pack: 6 • \$500.00



Following stints with several prominent railroads and locomotive manufacturers, Matthias N. Forney went to work for the Illinois Central Railroad in 1861, where he designed and patented the first of the "Forney" type locomotives. Characterized by a trailing truck positioned under the coal bunker/water tank, Forney designs integrated the locomotive and fuel bunker on one frame, allowing for smooth operation in tight curves. Ideal for fast-paced railroad operation, Forneys were produced by many locomotive manufacturers to serve urban elevated railroads and narrow gauge short lines during the middle to late steam era. Two examples are our *Baldwin Forney 2-4-4*, offered in inside and outside frame versions.

Features include:

- DCC sound-equipped
- dual-mode NMRA-compliant decoder for DCC or DC operation
- die-cast frame and boiler
- vestibule cab with operating doors and interior detail
- precision motor
- operating LED headlight
- separately applied detail parts



**OUTSIDE FRAME
PAINTED, UNLETTERED**
Item No. 25498



**INSIDE FRAME
PAINTED, UNLETTERED**
Item No. 25499

Decoder features include:

- authentic sound effects uniquely appropriate to each model
- three whistles to choose from in each model
- real-time whistle for creating authentic signals
- high-quality 16-bit digital sound
- advanced motor control features, including load compensation and silent drive to provide smooth, quiet operation
- supports all recognized programming methods

DCC ON BOARD™

Baldwin Outside Frame 2-8-0 Consolidation

Performs best on 22" radius curves or greater.

Standard Pack: 6 • \$300.00



Manufactured throughout the first half of the 20th century, this versatile 30-inch gauge locomotive was used domestically and abroad in freight, industrial, and passenger service. Each version of the DCC-equipped 2-8-0 also includes wood load, coal load, oil bunker and two stack styles (onion and tapered).

Features include:

- DCC-equipped for speed, direction, and lighting
- dual-mode NMRA-compliant decoder for DCC or DC operation
- precision motor
- die-cast chassis, boiler, and tender frame
- see-through clearance under boiler
- spoked, solid, or outside bearing lead trucks per prototype
- operating headlight
- separately applied detail parts

Baldwin Forney 2-4-4 Steam Locomotive

Performs best on 18" radius curves or greater.

Standard Pack: 6 • \$325.00

Following stints with several prominent railroads and locomotive manufacturers, Matthias N. Forney went to work for the Illinois Central Railroad in 1861, where he designed and patented the first of the "Forney" type locomotives. Characterized by a trailing truck positioned under the coal bunker/water tank, Forney designs integrated the locomotive and fuel bunker on one frame, allowing for smooth operation in tight curves. Ideal for fast-paced railroad operation, Forneys were produced by many locomotive manufacturers to serve urban elevated railroads and narrow gauge short lines during the middle to late steam era. Two examples are our *Baldwin Forney 2-4-4*, offered in inside and outside frame versions.

Features include:

- DCC-equipped for speed, direction, and lighting
- dual-mode NMRA-compliant decoder for DCC or DC operation
- die-cast frame and boiler
- vestibule cab with operating doors and interior detail
- precision motor
- operating LED headlight
- separately applied detail parts



INSIDE FRAME - SANDY RIVER & RANGELY LAKE
Item No. 25477



OUTSIDE FRAME - PAINTED, UNLETTERED
Item No. 25478



INSIDE FRAME - PAINTED, UNLETTERED
Item No. 25479

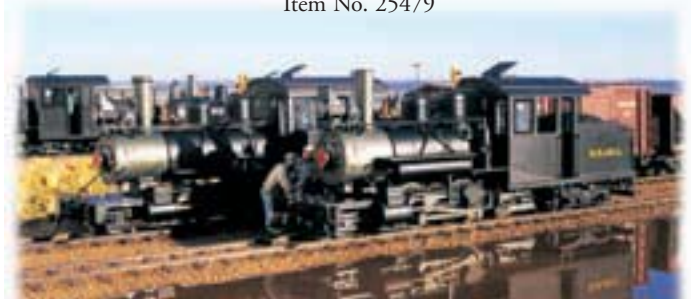

COLORADO MINING CO.
Item No. 25962



PAINTED, UNLETTERED - BLACK
Item No. 25999



ALL PRODUCTS ON THESE PAGES
EQUIPPED WITH BODY-MOUNTED
E-Z MATE® MARK II COUPLERS

Baldwin 4-6-0 Steam Locomotive

Performs best on 18" radius curves or greater.

Standard Pack: 6 • \$499.00



Along with its 4-4-0 cousin, the 4-6-0 configuration was one of the most common wheel arrangements offered by locomotive manufacturers. The combination of speed and traction made 4-6-0s suitable for both freight and passenger service, and nearly every railroad used them. Our On30 locomotives are based on stock models from Baldwin's narrow gauge catalog.

Features include:

- DCC sound-equipped
- dual-mode NMRA-compliant decoder with 8-pin plug
- flywheel drive
- idler gear box
- die-cast frame, boiler, and cab
- machined, blackened wheels
- wood cab and steel cab versions
- additional die-cast detail parts
- easy-to-install options, including three headlight/backup light styles (oil, acetylene, electric), three stack styles (cap, Rushton, tapered), and three fuel loads (wood, coal, oil) included with each model
- E-Z Mate® Mark II couplers

Decoder features include:

- authentic sound effects uniquely appropriate to each model
- three whistles to choose from in each model
- real-time whistle for creating authentic signals
- high-quality 16-bit digital sound
- advanced motor control features, including load compensation and silent drive to provide smooth, quiet operation
- supports all recognized programming methods



**PAINTED, UNLETTERED with STEEL CAB
BLACK with RED WINDOWS & WHITE TRIM**
Item No. 28901

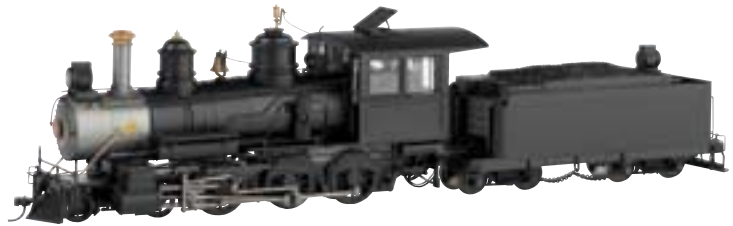

**PAINTED, UNLETTERED with WOOD CAB
and FLUTED DOMES - BLACK**
Item No. 28902

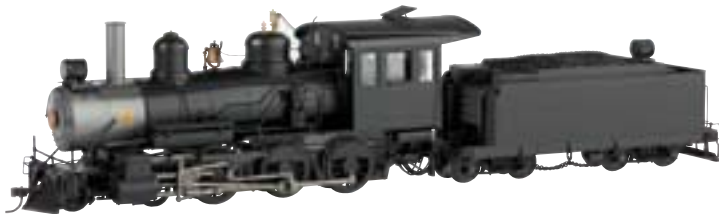

PAINTED, UNLETTERED with STEEL CAB - BLACK
Item No. 28903



**ET&WNC #12 with STEEL CAB
BLACK with RED WINDOWS & WHITE PINSTIPES**
Item No. 28904



**ET&WNC #14 with STEEL CAB
GREEN with GOLD LINING & RED WINDOWS**
Item No. 28905



**GREENBRIER & BIG RUN LUMBER CO. #32
with STEEL CAB**
Item No. 28906



ALL PRODUCTS ON THESE PAGES
EQUIPPED WITH BODY-MOUNTED
E-Z MATE® MARK II COUPLERS

Baldwin 4-6-0 Steam Locomotive



Performs best on 22" radius curves or greater.

Standard Pack: 6 • \$399.00

Along with its 4-4-0 cousin, the 4-6-0 configuration was one of the most common wheel arrangements offered by locomotive manufacturers. The combination of speed and traction made 4-6-0s suitable for both freight and passenger service, and nearly every railroad used them. Our On30 locomotives are based on stock models from Baldwin's narrow gauge catalog.

Features include:

- DCC-equipped for speed, direction, and lighting
- dual-mode NMRA-compliant decoder with 8-pin plug
- flywheel drive
- idler gear box
- die-cast frame, boiler, and cab
- machined, blackened wheels
- wood cab and steel cab versions
- additional die-cast detail parts
- easy-to-install options, including three headlight/backup light styles (oil, acetylene, electric), three stack styles (cap, Rushton, tapered), and three fuel loads (wood, coal, oil) included with each model
- E-Z Mate® Mark II couplers



**GREENBRIER & BIG RUN
LUMBER CO. with STEEL CAB**
Item No. 28657



**ET&WNC #12 with STEEL CAB
GREEN with GOLD LINING & RED WINDOWS**
Item No. 28670



**ET&WNC #11 with STEEL CAB
BLACK with RED WINDOWS**
Item No. 28671



**PAINTED, UNLETTERED
with STEEL CAB - BLACK**
Item No. 28696



**PAINTED, UNLETTERED
with WOOD CAB and FLUTED DOMES - BLACK**
Item No. 28697



**PAINTED, UNLETTERED with
STEEL CAB - BLACK with RED WINDOWS & WHITE TRIM**
Item No. 28698

Inside Frame 4-4-0 American Steam Locomotive

Performs best on 18" radius curves or greater.

Standard Pack: 6 • \$375.00

Not only was the 4-4-0 configuration the best-selling wheel arrangement of all steam locomotives, it was the longest running as well, first appearing in the late 1830s and seeing service until the end of the steam era. The 4-4-0 was a multipurpose locomotive that was stable, quick on rough track, and easy to maintain. As a result, more than 80,000 Americans were built for railroads of all gauges. Painted and striped "as delivered," our model is based on Baldwin designs for 30-inch railroads, with multiple-style accessory features that allow modelers to customize their locomotive.

Features include:

- DCC-equipped for speed, direction, and lighting
- dual-mode NMRA-compliant decoder with 8-pin plug for DCC or DC operation
- die-cast cab, boiler, frame, lead truck, drivers, and tender frame
- completely hidden precision motor with flywheel and reduction gear box for scale speed operation
- room for speaker
- wood cab and steel cab versions
- wood load, coal load, and oil bunker, plus two stack styles (tapered and cap) included with all versions
- two easily interchangeable pilot styles (footboard and road), plus two lead truck styles (spoked and solid) included with all versions
- photo-etched brass fuel bunker extensions for larger loads
- *E-Z Mate*® Mark II couplers, front and rear

DCCTM
ON BOARD



PAINTED, UNLETTERED - BLACK with GRAPHITE SMOKE & FIRE BOX
(1890s Wood Cab & Oil Headlight)
Item No. 28301



PAINTED, UNLETTERED - BLACK
with RED CAB WINDOWS, GOLD PINSTRIPES & LINING
(1890s Wood Cab & Oil Headlight)
Item No. 28302



PAINTED, UNLETTERED - BLACK
with GRAPHITE SMOKE & FIRE BOX, RED CAB WINDOWS, BRASS TRIM
(1890s Wood Cab & Oil Headlight)
Item No. 28303



PAINTED, UNLETTERED - BLACK with GRAPHITE SMOKE & FIRE BOX
(1910 - 1920s Steel Cab & Electric Visor Headlight)
Item No. 28304



PAINTED, UNLETTERED - BLACK with RED CAB
WINDOWS, WHITE TRIM
(1910 - 1920s Steel Cab & Electric Visor Headlight)
Item No. 28305



PAINTED, UNLETTERED - BLACK with
RED CAB WINDOWS, WHITE PINSTRIPES
(1910 - 1920s Steel Cab & Electric Visor Headlight)
Item No. 28306



DCC ON BOARD - Just like the real thing

Outside Frame Modern 4-4-0 Steam Locomotive



Performs best on 18" radius curves or greater.

Standard Pack: 6 • \$370.00

The prototype that inspired our On30 locomotive was a later model 4-4-0 design built at the end of the steam era. Painted and striped "as delivered," modelers can customize their locomotive with their own lettering and multiple-style accessory features.

Features include:

- DCC-equipped for speed, direction, and lighting
- dual-mode NMRA-compliant decoder with 8-pin plug for DCC or DC operation
- flywheel drive
- idler gear box
- die-cast frame, boiler, and cab
- machined, blackened wheels
- additional die-cast detail parts
- three stack styles (cap, Rushton, tapered), and three fuel loads (wood, coal, oil) included with each model
- E-Z Mate® Mark II couplers



PAINTED, UNLETTERED - BLACK
(1920s Steel Cab & Foot Board Pilot)
Item No. 28321



PAINTED, UNLETTERED - BLACK with RED WINDOWS and WHITE STRIPES
(1920s Wood Cab & Foot Board Pilot)
Item No. 28322



PAINTED, UNLETTERED - RUSSIA IRON with RED WINDOWS & SILVER TRIM
(1920s Steel Cab & Road Pilot)
Item No. 28323



PAINTED, UNLETTERED - BLACK with GRAPHITE SMOKE & FIRE BOX
(1930s - 1940s Wood Cab & Road Pilot)
Item No. 28324



PAINTED, UNLETTERED - BLACK with RED WINDOWS & SILVER TRIM
(1930s - 1940s Steel Cab & Foot Board Pilot)
Item No. 28325



PAINTED, UNLETTERED - BLACK with RED WINDOWS & WHITE PINSTRIPES
(1930s - 1940s Steel Cab & Foot Board Pilot)
Item No. 28326



ALL PRODUCTS ON THESE PAGES
EQUIPPED WITH BODY-MOUNTED
E-Z MATE® MARK II COUPLERS



COLORADO & SOUTHERN #21
Item No. 25241

NEW

DENVER & RIO GRANDE WESTERN™ #136
(green & black; not shown)
Item No. 25242



PAINTED, UNLETTERED – BUMBLE BEE
Item No. 25249



PAINTED, UNLETTERED – BLACK
Item No. 25299

Narrow Gauge 2-6-0 Steam Locomotive and Tender

Performs best on 18" radius curves or greater.

Standard Pack: 6 • \$175.00

Features include:

- operating headlight
- completely hidden drive train
- see-through clearance under boiler
- precision motor (with hardened carbon brushes)
- numerous metal detail parts
- finescale pilot
- sprung center axle for superior tracking performance and electrical pickup
- short-coupled tender with coal load



**BODY-MOUNTED
E-Z MATE® MARK II COUPLERS**

Closed Streetcar (with headlights and lighted interior)

Performs best on 15" radius curves or greater.

Standard Pack: 6 • \$75.00



CHRISTMAS
Item No. 25127



UNITED TRACTION
Item No. 25128



Rail Truck

Performs best on 15" radius curves or greater.

Standard Pack: 6 • \$175.00



Along with the financial devastation of the Great Depression, the Rio Grande Southern faced natural disaster as well when a mudslide cut the railroad into two pieces. A divided line severely reduced rail traffic, and the struggle to remain financially solvent in the face of these difficulties inspired the RGS to develop Motor Car #1, a cost-effective solution to the drop-off in passenger, freight, and US Mail traffic. Based on the replica of Rio Grande Southern Motor #1 that resides in Colorado's Ridgeway Railroad Museum, our DCC-equipped *Rail Truck* brings whimsy and realism to narrow gauge modeling.

Features include:

- DCC-equipped for speed, direction, and lighting
- dual-mode NMRA-compliant decoder for DCC or DC operation
- die-cast frame, bed, and hood
- LED headlights and rear marker light
- full interior with seats and instrument panel
- painted driver figure



GREENBRIER & BIG RUN LUMBER CO.
Item No. 29157



POCAHONTAS LUMBER CO.
Item No. 29160



MIDWEST QUARRY & MINING CO.
Item No. 29161

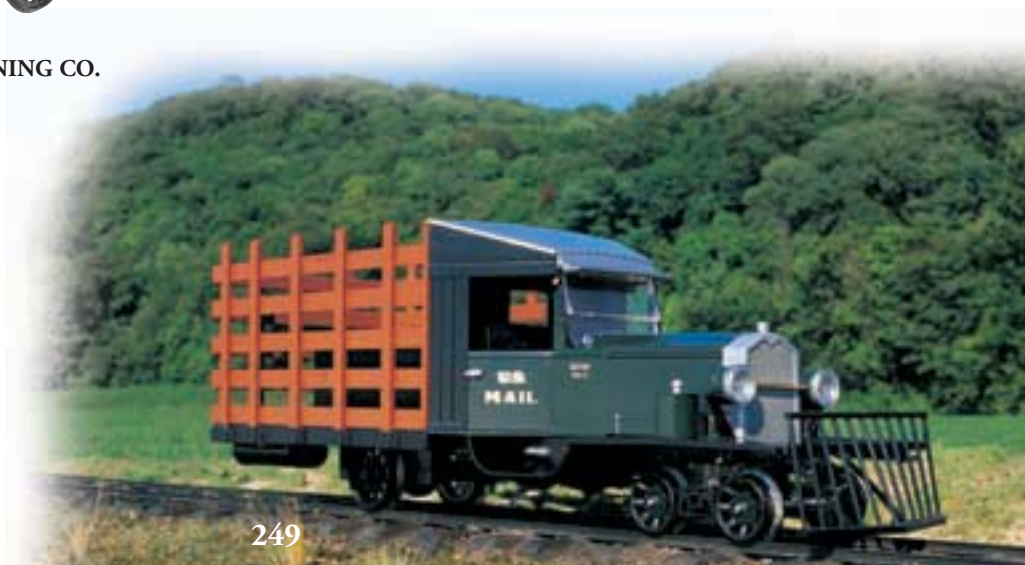

Railbus & Trailer

Performs best on 18" radius curves or greater.

Standard Pack: 6 • \$275.00

Standard gauge railbuses were produced by many manufacturers, but narrow gauge versions, though offered, were rarely seen. This inspired us to follow through on a 30-inch model that never made it past the drawing board. We're pleased to bring this design to life with models of "what might have been."

Features include:

- DCC-equipped for speed, direction, and lighting
- dual-mode NMRA-compliant decoder with 8-pin plug
- prototypical four-wheel drive
- hidden precision motor
- hidden flywheel
- scale-speed gearing
- paint schemes based on period styles
- removable roof
- full interior with seats, stove, operator's controls, gauges, gearshift, and pedals
- painted engineer figure
- LED interior lights and operating LED marker lights (railbus and trailer)
- designed for aftermarket sound installation
- *E-Z Mate*® Mark II couplers



GREENBRIER & BIG RUN LUMBER CO.
Item No. 28457



POCAHONTAS LUMBER CO.
Item No. 28460



MIDWEST QUARRY & MINING CO.
Item No. 28461



COLORADO MINING CO.
Item No. 28462



LITTLE RIVER LOGGING CO.
Item No. 28463



**PAINTED, UNLETTERED
SILVER & BLACK**
Item No. 28499



**ALL PRODUCTS ON THESE PAGES
EQUIPPED WITH BODY-MOUNTED
E-Z MATE® MARK II COUPLERS**

DCC ON BOARD

Two-Door Baggage Car (with lighted interior)

Standard Pack: 6 • \$60.00



UNLETTERED - BURGUNDY & BLACK
Item No. 26498



UNLETTERED - OLIVE
Item No. 26499

Combine Car (with lighted interior)

Standard Pack: 6 • \$60.00



UNLETTERED - BURGUNDY & BLACK
Item No. 26198



UNLETTERED - OLIVE
Item No. 26199

Observation Car (with lighted interior)

Standard Pack: 6 • \$60.00



UNLETTERED - BURGUNDY & BLACK
Item No. 26298



UNLETTERED - OLIVE
Item No. 26299



Jackson & Sharp Coach (with lighted interior)



Standard Pack: 6 • \$50.00

Features include:

- track powered lighting
- removable roof
- full, painted interior



PENNSYLVANIA
Item No. 26314



DENVER & RIO GRANDE WESTERN™
Item No. 26318



UNLETTERED - BURGUNDY & BLACK
Item No. 26398

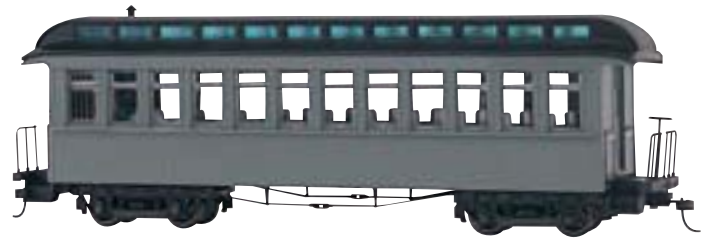

UNLETTERED - OLIVE
Item No. 26399

Reefer

Standard Pack: 6 • \$55.00



DENVER & RIO GRANDE WESTERN™
Item No. 27418



PENNSYLVANIA UNION LINE
Item No. 27464



ALL PRODUCTS ON THESE PAGES
EQUIPPED WITH BODY-MOUNTED
E-Z MATE® MARK II COUPLERS

Box Car

Standard Pack: 6 • \$43.00



BALTIMORE & OHIO®
Item No. 27012



BACHMANN 175th ANNIVERSARY
Item No. 27017



CHRISTMAS FRUITCAKE CAR
Item No. 27044



PAINTED, UNLETTERED
Item No. 27099

Pulpwood Car (with cast resin load)

Standard Pack: 6 • \$70.00



GREENBRIER & BIG RUN LUMBER CO.
Item No. 26857



LITTLE RIVER LOGGING CO.
Item No. 26863



CAROLINA PULPWOOD & PAPER CO.
Item No. 26878



Ventilated Box Car

Standard Pack: 6 • \$55.00



DENVER & RIO GRANDE WESTERN™
Item No. 27618



SOUTH PACIFIC COAST
Item No. 27634



CHESAPEAKE & DELAWARE
Item No. 27635



LAWNDALE
Item No. 27636



BIG SANDY & CUMBERLAND
Item No. 27637



ATLANTIC & DANVILLE
Item No. 27638



PAINTED, UNLETTERED
Item No. 27699

Tank Car

Standard Pack: 6 • \$43.00



ZEROLENE
Item No. 27146



ASSOCIATED
Item No. 27148

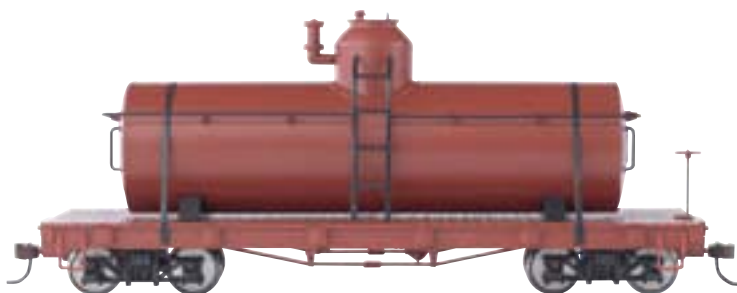

PAINTED, UNLETTERED - OXIDE RED
Item No. 27197



PAINTED, UNLETTERED - SILVER
Item No. 27198



PAINTED, UNLETTERED - BLACK
Item No. 27199



ALL PRODUCTS ON THESE PAGES
EQUIPPED WITH BODY-MOUNTED
E-Z MATE® MARK II COUPLERS

Gondola

Standard Pack: 6 • \$39.00



DENVER & RIO GRANDE WESTERN™
Item No. 27218



PAINTED, UNLETTERED
Item No. 27299

Flat Car

Standard Pack: 6 • \$39.00



DENVER & RIO GRANDE WESTERN™
Item No. 27318



COLORADO & SOUTHERN
Item No. 27323



BLACK - DATA ONLY
(not shown)
Item No. 27398



PAINTED, UNLETTERED
Item No. 27399

Stock Car

Standard Pack: 6 • \$43.00

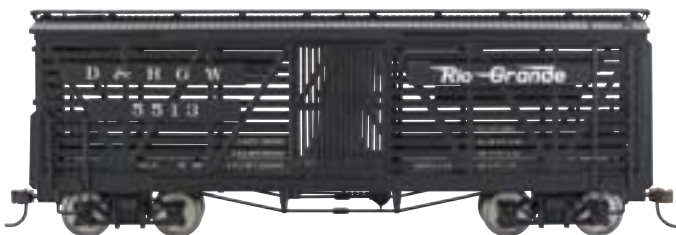

DENVER & RIO GRANDE WESTERN™
Item No. 27518



PAINTED, UNLETTERED
Item No. 27599

High-Side Gondola (with coal load)

Standard Pack: 6 • \$43.00



DENVER & RIO GRANDE WESTERN™
Item No. 27818



COLORADO & SOUTHERN
Item No. 27823



PAINTED, UNLETTERED – BROWN
Item No. 27899

2-Bay Steel Hopper (two per box)

Standard Pack: 6 • \$99.00



DENVER & RIO GRANDE WESTERN™
(two per box)
Item No. 27918



EAST BROAD TOP
(two per box)
Item No. 27930



PAINTED, UNLETTERED - OXIDE RED
(two per box)
Item No. 27999



ALL PRODUCTS ON THESE PAGES
EQUIPPED WITH BODY-MOUNTED
E-Z MATE® MARK II COUPLERS



Logging and Mining Cars (three cars per box)

Standard Pack: 6

These cars feature die-cast frames and are packed three to a box.



**BODY-MOUNTED
E-Z MATE®
MARK II COUPLERS**



SKELETON LOG CARS with RESIN LOGS
(three cars per box)
Item No. 27391 • \$105.00



WOOD SIDE-DUMP CARS
(three cars per box)
Item No. 29801 • \$88.00



V-DUMP CARS
(three cars per box)
Item No. 29802 • \$88.00

Camp Cars

Standard Pack: 6 • \$60.00

A successful logging operation needs its crew and equipment to be in top condition, and our camp cars deliver the supplies and services to keep your backwoods line running smoothly. All feature metal wheels and arch bar trucks.



SAW FILER'S CAR
Item No. 26994



MAINTENANCE-OF-WAY CAR
Item No. 26995

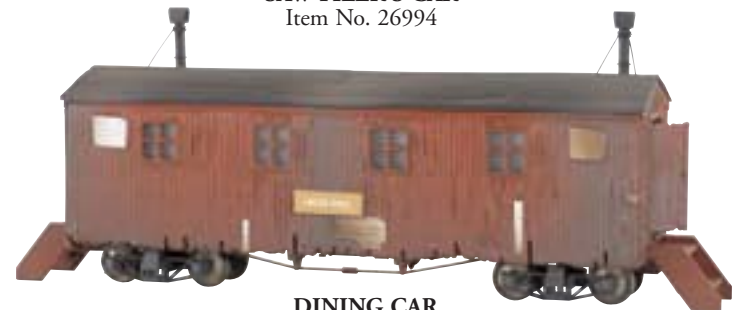

DINING CAR
Item No. 26996



COMMISSARY CAR
Item No. 26997



BUNK CAR
Item No. 26998

Caboose (with lighted interior)

Standard Pack: 6 • \$55.00



MIDWEST QUARRY & MINING COMPANY #7
Item No. 27761



COLORADO MINING #3
Item No. 27762



PAINTED, UNLETTERED with ROUND ROOF
Item No. 27798



PAINTED, UNLETTERED with CUPOLA
Item No. 27799



BODY-MOUNTED
E-Z MATE®
MARK II COUPLERS



Wood Side-Door Caboose (with lighted interior)

Standard Pack: 6 • \$75.00



SANDY RIVER & RANGELEY LAKE
Item No. 26777



PAINTED, UNLETTERED - CABOOSE RED
Item No. 26796



PAINTED, UNLETTERED - OXIDE BROWN
Item No. 26797



PAINTED, UNLETTERED - OXIDE RED
Item No. 26798



PAINTED, UNLETTERED - YELLOW & BLACK
Item No. 26799

ALL PRODUCTS ON THIS PAGE
EQUIPPED WITH BODY-MOUNTED
E-Z MATE® MARK II COUPLERS



Complete Trucks with Wheels

Standard Pack: 6



ARCH BAR FREIGHT TRUCKS
Item No. 29901 • \$16.00 per pair



DIE-CAST PASSENGER TRUCKS
Item No. 29902 • \$16.00 per pair



**LONG WHEELBASE
ARCH BAR FREIGHT TRUCKS**
Item No. 29903 • \$18.00 per pair



**LOW FRAME 4'1"
ARCH BAR FREIGHT TRUCKS**
Item No. 29904 • \$18.00 per pair



VULCAN FREIGHT TRUCKS
Item No. 29905 • \$16.00 per pair

Accessories



FREIGHT CAR UNDERFRAME - BLACK
(3 per pack)
Item No. 29906 • Standard Pack: 6
\$25.00

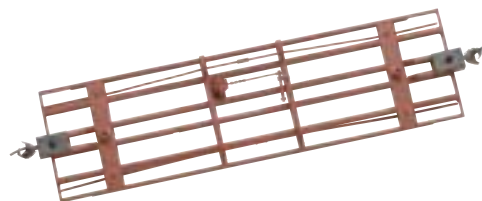

FREIGHT CAR UNDERFRAME - OXIDE RED
(3 per pack)
Item No. 29907 • Standard Pack: 6
\$25.00



**2-6-0 PILOTS with OPERATING
MAGNETIC COUPLERS**
(2 per pack)
Item No. 29908 • Standard Pack: 6
\$16.00



RESIN PULPWOOD LOAD
(1 per pack)
Item No. 29910 • Standard Pack: 6
\$39.00

1:20.3 Two-Truck Climax Locomotive

Performs best on 4' diameter curves or greater.

Standard Pack: 1 • \$1500.00



The Class "B" two-truck locomotive, introduced by Climax in 1893, featured a horizontal boiler with slanted cylinders. The new design was an instant success and quickly became Climax's most popular model, remaining so throughout the company's history. Bachmann is proud to present this Climax model with *Soundtraxx*® *Tsunami*® sound technology that allows you to enjoy every authentic whistle, bell, chuff, and much more in realistic high-quality 16-bit sound.

Features include:

- DCC sound-equipped
- nonproprietary plug-and-play electronics interface to accommodate the control system of your choice, including DC, NMRA DCC, and radio control/battery operation
- choose track or battery power pickup, operation according to NMRA or Large Scale railroading practices, motor power on/off, and DCC or DC operation of cab lights, firebox flicker, and ash pan glow with a center "off" position
- switch behind the smoke box door with center "off" position to choose either DCC or DC operation of the smoke unit
- optical sensors in the locomotive that give you the option of adjusting the timing and count of steam chuffs
- realistic firebox flicker and ash pan glow
- electrical pickup on all wheels
- precision-balanced can motor
- super-detailed power trucks with accurate sideframes, brake beams, brake hangers, brake shoes, and distinctive Climax spoked drivers
- die-cast metal I beam frames and motor mounts
- prototypically correct operating Johnson bar and inside Stephenson valve gear
- constant lighting of the LED headlight and cab light
- numerous prototype details including blackened metal handrails and coupler lift bars; air pump; accurately scaled sand lines and additional piping; brass bell, pop valves, and whistle; electric generator; and scale rivet detail
- choice of three smokestack styles
- locomotive cab with operating doors, windows and roof hatch, authentically detailed with globe valves, water sight glass, gauges, throttle, air brake stand, reversing (Johnson) bar, and piping
- choice of coal or oil fuel load



CLEAR LAKE LUMBER CO. #7
Item No. 86093

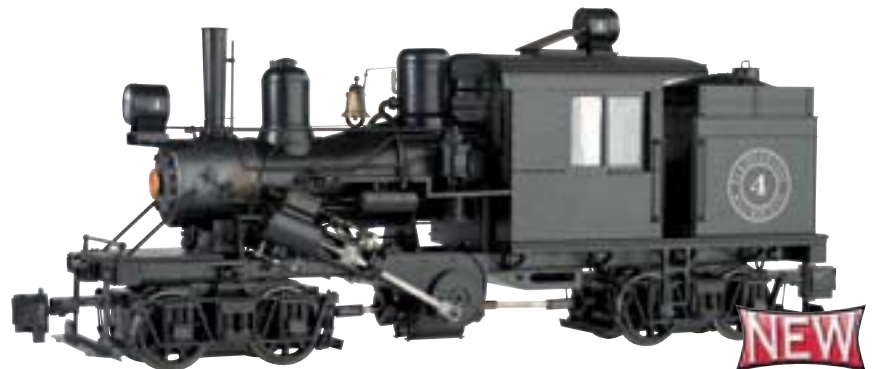

ELK RIVER COAL & LUMBER CO. #4
Item No. 86094

Decoder features include:

- authentic sound effects uniquely appropriate to each model
- three whistles to choose from in each model
- real-time whistle for creating authentic signals
- high-quality 16-bit digital sound
- advanced motor control features, including load compensation and silent drive to provide smooth, quiet operation
- supports all recognized programming methods

1:20.3 Two-Truck Climax Locomotive (continued)



CLIMAX #3
(demonstrator)
Item No. 86095



BAYSIDE LUMBER CO. #4
Item No. 86096



PAINTED, UNLETTERED – BLACK with
WHITE RUNNING BOARD STRIPING
Item No. 86097



PAINTED, UNLETTERED – BLACK with RED WINDOWS,
WHITE PINSTRIPING, & WHITE RUNNING BOARDS
Item No. 86098



SOUND ON BOARD

1:20.3 Two-Truck Climax Locomotive

Performs best on 4' diameter curves or greater.

Standard Pack: 1 • \$1350.00

The Class "B" two-truck locomotive, introduced by Climax in 1893, featured a horizontal boiler with slanted cylinders. The new design was an instant success and quickly became Climax's most popular model, remaining so throughout the company's history.

Features include:

- ready for decoder installation of your choice
- nonproprietary plug-and-play electronics interface to accommodate the control system of your choice, including DC, NMRA DCC, and radio control/battery operation
- choose track or battery power pickup, operation according to NMRA or Large Scale railroading practices, motor power on/off, and DCC or DC operation of cab lights, firebox flicker, and ash pan glow with a center "off" position
- switch behind the smoke box door with center "off" position to choose either DCC or DC operation of the smoke unit
- optical sensors in the locomotive that give you the option of adjusting the timing and count of steam chuffs
- realistic firebox flicker and ash pan glow
- electrical pickup on all wheels
- precision-balanced can motor
- super-detailed power trucks with accurate sideframes, brake beams, brake hangers, brake shoes, and distinctive Climax spoked drivers
- die-cast metal I beam frames and motor mounts
- prototypically correct operating Johnson bar and inside Stephenson valve gear
- constant lighting of the LED headlight and cab light
- numerous prototype details including blackened metal handrails and coupler lift bars; air pump; accurately scaled sand lines and additional piping; brass bell, pop valves, and whistle; electric generator; and scale rivet detail
- choice of three smokestack styles
- locomotive cab with operating doors, windows and roof hatch, authentically detailed with globe valves, water sight glass, gauges, throttle, air brake stand, reversing (Johnson) bar, and piping
- choice of coal or oil fuel load



CLEAR LAKE LUMBER CO. #6
Item No. 85093



ELK RIVER COAL & LUMBER CO. #3
Item No. 85094

1:20.3 Two-Truck Climax Locomotive (continued)



CLIMAX #2
(demonstrator)
Item No. 85095



BAYSIDE LUMBER CO. #3
Item No. 85096



PAINTED, UNLETTERED – BLACK with
WHITE RUNNING BOARD STRIPING
Item No. 85097



PAINTED, UNLETTERED – BLACK with RED WINDOWS,
WHITE PINSTRIPING, & WHITE RUNNING BOARDS
Item No. 85098



1:20.3 Large Scale 55-Ton Three-Truck Shay

Performs best on 8' diameter curves or greater.

Standard Pack: 1 • \$1500.00

Inspired by a classic Lima steel cab design (circa 1908 – 1915), this third member of our *Large Scale Shay* family was created through extensive research and our continued commitment to 1:20.3 finescale railroading.

Features include:

- DCC sound-equipped
- die-cast construction, including die-cast gear boxes
- all-wheel drive
- steel cab with detailed interior
- numerous detail parts
- operating headlight and backup light
- operating smoke unit
- three-position polarity switch for conformance to NMRA standards or large scale model railroading practices, and a center/off position



LITTLE RIVER LUMBER CO. #2147
Item No. 82697



WEST SIDE LUMBER CO. #4
Item No. 82698



PAINTED, UNLETTERED - BLACK
with RED & WHITE TRIM
Item No. 82699

Decoder features include:

- authentic sound effects uniquely appropriate to each model
- three whistles to choose from in each model
- real-time whistle for creating authentic signals
- high-quality 16-bit digital sound
- advanced motor control features, including load compensation and silent drive to provide smooth, quiet operation
- supports all recognized programming methods

1:20.3 Scale Narrow Gauge 55-Ton Three-Truck Shay

Performs best on 8' diameter curves or greater.

Standard Pack: 1 • \$1300.00

Inspired by a classic Lima steel cab design (circa 1908 – 1915), this third member of our *Large Scale Shay* family was created through extensive research and our continued commitment to 1:20.3 finescale railroading.

Features include:

- DCC ready
- die-cast construction, including die-cast gear boxes
- all-wheel drive
- steel cab with detailed interior
- numerous detail parts
- operating headlight and backup light
- operating smoke unit
- three-position polarity switch for conformance to NMRA standards or large scale model railroading practices, and a center/off position



OREGON LUMBER COMPANY #110
Item No. 82494



MEADOW RIVER LUMBER COMPANY #7
Item No. 82496



PAINTED, UNLETTERED – BLACK with RED & WHITE TRIM
Item No. 82498



PAINTED, UNLETTERED – BLACK
Item No. 82499

Shay Power Trucks with Die-Cast Power Blocks

Standard Pack: 3 • \$300.00

We're happy to offer new technology for an old favorite in the *Spectrum*® line with backward-compatible *Shay Power Trucks*. Die-cast power blocks and improved pickup make this a "must have" item for Large Scale Shay modelers and kitbashers.



SHAY POWER TRUCKS – 1 PAIR
(with die-cast power blocks)
Item No. 88999

1:20.3 Baldwin 2-6-6-2 Articulated Saddle Tank Locomotive

Performs best on 8' diameter curves or greater.

Standard Pack: 1 • \$1425.00

The 1920s marked the end of a logging push in the northwestern United States, where lumber companies needed more powerful engines to efficiently handle greater load capacities and quicker turnaround times demanded by the ever-increasing distances from the logging camps to the sawmills. In 1928, Biles Coleman Lumber Company approached the Baldwin Locomotive Works with a request for a narrow gauge 2-6-6-2 capable of handling operations on a recently developed twenty mile logging line. Baldwin responded with a scaled down version of an existing standard gauge design, which was promptly approved by Biles Coleman. Unfortunately, the Great Depression intervened and Biles-Coleman never placed an order with Baldwin. After more than 80 years, we're finishing the job with this exquisite model.

Features include:

- nonproprietary plug-and-play electronics interface to accommodate the control system of your choice, including DC, NMRA DCC, and radio control/battery operation
- two custom wound motors with flywheels
- two idler gear boxes
- prototypical equalized chassis under both power assemblies
- all-wheel driver pickup
- die-cast scale knuckle couplers, front and rear
- constant lighting of LED headlight, cab light, and rear light
- easy access to four switches in boiler to choose track or battery power pickup, operation according to NMRA or large scale model railroading practices, motor power on/off with or without lights, and center "off" position for DCC or DC operation of cab light and firebox flicker
- switch behind smokebox door with center "off" position for DCC or DC operation of smoke unit
- die-cast offset shank couplers also included for use with other popular brands of narrow gauge couplers



LITTLE RIVER LOGGING CO.
Item No. 82894



1:20.3 Baldwin 2-6-6-2 Articulated Saddle Tank Locomotive (continued)



YELLOW PINE LUMBER CO.
Item No. 82895



OREGON LUMBER CO.
Item No. 82896



WEST VIRGINIA PAPER & PULP CO.
Item No. 82897



PAINTED, UNLETTERED - BLACK
Item No. 82898



PAINTED, UNLETTERED - BLACK with RED WINDOWS & WHITE STRIPES
Item No. 82899

1:20.3 Large Scale K-27 Steam Locomotive

Performs best on 8' diameter curves or greater.

Standard Pack: 1 • \$1650.00

As the 19th century came to a close, the older, smaller engines of the Denver & Rio Grande's narrow gauge railroad struggled to haul freight and passenger traffic over the line's steep grades and tight curves. After soliciting design specifications from several builders for a locomotive able to handle at least twice the tonnage of the engines previously in use, the railroad selected Baldwin Design Specification W4213, later known as the K-27. A total of fifteen K-27s were ordered and assigned road numbers 450 to 464, with numerous modifications made throughout the course of their many years of operation. Honoring Baldwin's innovative design, we're proud to present these *Spectrum*® K-27 locomotives, each with details, paint scheme, cab, and tender shell specific to an individual road number at a certain time in its service career.

Features include:

- fully equalized locomotive suspension as on the prototype, including individually sprung drivers, trailing truck, and floating gear box
- nonproprietary plug-and-play electronics interface to accommodate DC, NMRA DCC, and remote control/battery operation
- motor with ball bearings and brass machined flywheel
- complete die-cast frame and chassis with numerous die-cast parts throughout
- heavy-duty plugs and wiring
- optical sensors in cylinders for sound synchronization
- constant lighting for LED front and rear headlights and marker lights
- three-position switches with center "off" position for DCC or DC operation of smoke unit, cab light, and firebox
- all-wheel driver and tender pickup
- three switches in tender to choose track or battery power pickup, operation according to NMRA or Large Scale model railroading practices, and motor power on/off with or without lights
- room available for aftermarket sound installation
- complete brake rigging and shoes
- prototypical detailing throughout
- body-mounted die-cast scale knuckle couplers (longer coupler shanks included for use on tight radii); offset shank couplers also included



RIO GRANDE™ #453 with DOGHOUSE
Item No. 83093



RIO GRANDE™ #463 - FLYING GRANDE VERSION
(1940s - 1950s)
Item No. 83095

1:20.3 Large Scale K-27 Steam Locomotive (continued)



RIO GRANDE SOUTHERN #455 - SUNRISE HERALD
Item No. 83096



DENVER & RIO GRANDE WESTERN™ #455
Item No. 83097



PAINTED, UNLETTERED - BLACK with GREEN BOILER
Item No. 83098



PAINTED, UNLETTERED - BLACK
Item No. 83099



1:20.3 Baldwin 2-4-4 Forney Locomotive

Performs best on 8' diameter curves or greater.

Standard Pack: 1 • \$1250.00

Matthias Forney's locomotive was designed to power elevated and surface commuter railroads in America's rapidly growing cities. It was very successful in this role but its success seemed short-lived due to the electrification of these rail lines. The unique design of Forney's locomotive enabled it to live on and made it an ideal form of motive power on railroads hauling stone in quarries, pulling log trains, and harvesting rubber on plantations as far away as Brazil. Bachmann continues this tradition by bringing you a revolutionary design from the past and updating it with exciting new engineering features from the present.

Features include:

- nonproprietary plug-and-play electronics interface to accommodate the control system of your choice, including DC, NMRA DCC, and radio control/battery operation
- custom wound motor with flywheel
- heavy-duty driver and trailing truck electrical pickup
- exclusive truck locking mechanisms for multiple radii curve operation
- LED headlight and cab lighting
- highly detailed cab interiors featuring sliding windows and operating doors
- die-cast scale knuckle couplers front and rear
- switch behind smokebox door with center "off" position for DCC or DC operation of smoke unit
- moveable ash pan grates with authentic ash pan "glow"
- glowing firebox (load compensated)
- blackened die-cast metal running gear featuring optical sensors for aftermarket sound synchronization
- hand-tooled coal load
- brass bell with bell chord
- numerous die-cast detail parts including pop valves, whistle, and piping
- easy access to electronics in coal bunker



OUTSIDE FRAME
SANDY RIVER & RANGELEY LAKE #12
Item No. 80996



INSIDE FRAME
SANDY RIVER & RANGELEY LAKE #11
Item No. 80997

1:20.3 Baldwin 2-4-4 Forney Locomotive (continued)



OUTSIDE FRAME
PAINTED, UNLETTERED - BLACK
Item No. 80998



INSIDE FRAME
PAINTED, UNLETTERED - BLACK
Item No. 80999

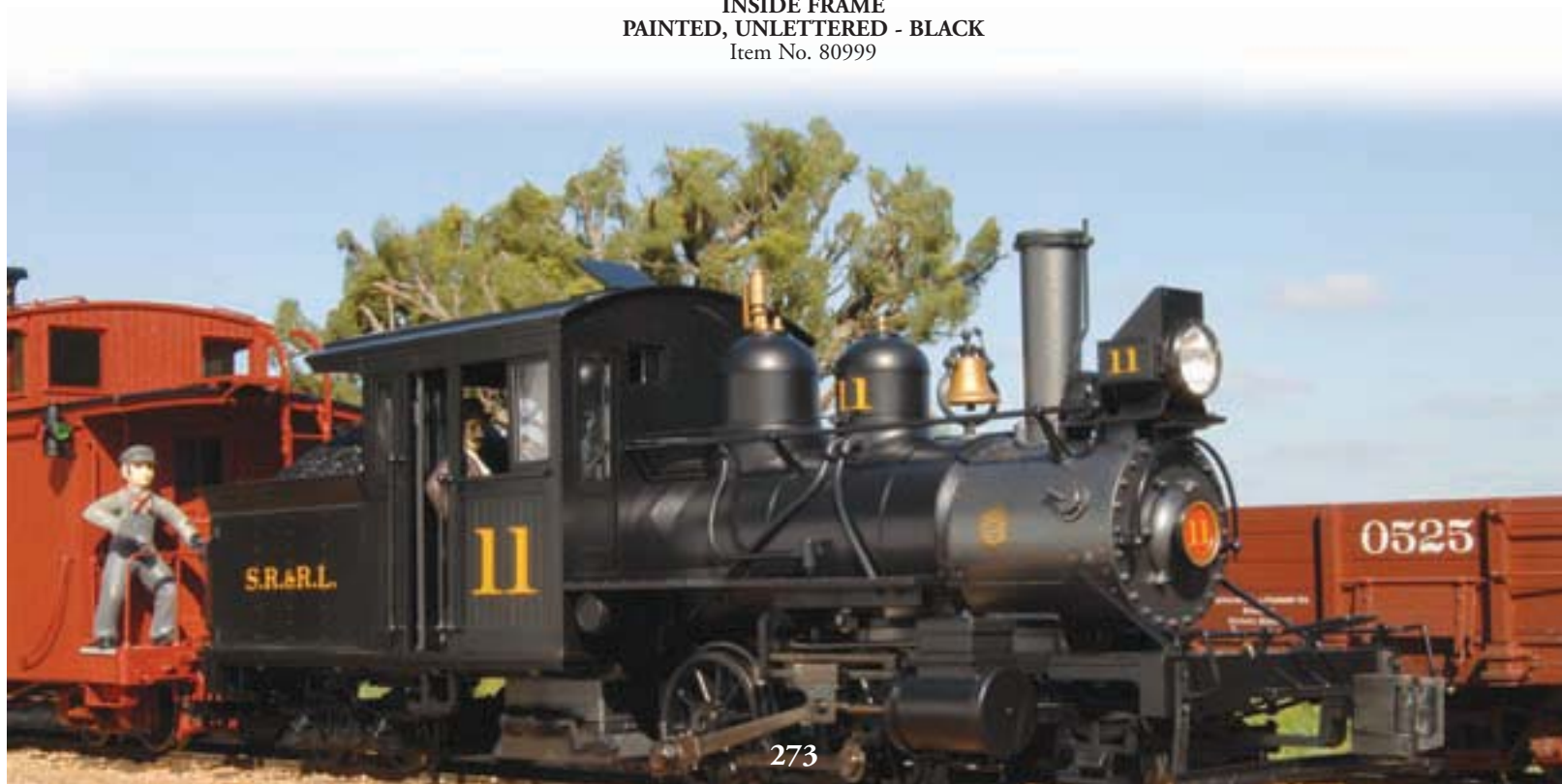

1:20.3 Scale Narrow Gauge 2-6-0 Mogul Steam Locomotive

Performs best on 8' diameter curves or greater.

Standard Pack: 1 • \$950.00

Along with a Baldwin 4-4-0, one of the prototypes for our 2-6-0 hauled 4 million customers throughout the grounds of the 1876 Centennial Exhibition held in Philadelphia. That's an impressive record of service this model is sure to emulate.

Features include:

- DCC ready
- LED headlight
- polarity selector switch for operation according to NMRA standards or large scale model railroading practice
- smoke generator with on-off switch
- load-synchronized LEDs in firebox and ashpan for realistic fire glow
- precision can motor
- metal frame
- complete backhead detail
- fully operational Stephenson valve gear with operating piston valves, Johnson bar, and linkage
- numerous separate detail parts
- metal handrails and piping
- prototypical, sprung axle bearings
- chemically blackened, machined metal wheels
- scale coupler pockets

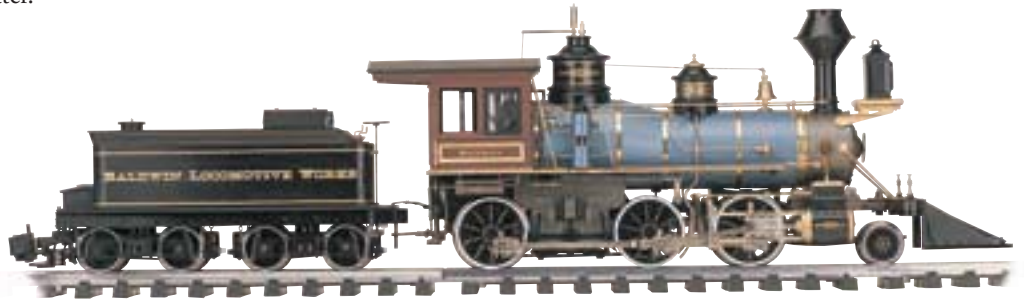

BALDWIN LOCOMOTIVE WORKS
Item No. 81495



1:20.3 Scale Narrow Gauge 0-4-0 Side Tank Porter

Performs best on 4' diameter curves or greater.

Standard Pack: 1 • \$325.00

Representing a stock model right off the pages of an H.K. Porter catalog, this side tank locomotive was commonly used in a variety of switching and industrial applications. Our 1:20.3 0-4-0 Side Tank Porter offers your railroad a tank configuration option to meet the needs of your growing industry.

Features include:

- DCC ready
- operating headlight
- smoke generator with on/off switch
- prototypical cab style
- full backhead detail
- heavy-duty can motor
- hidden gear box
- metal connecting rods and main rods
- three-position polarity switch for conformance to NMRA standards or large scale model railroading practices, and a center/off position



COLORADO MINING COMPANY
Item No. 82596



MIDWEST QUARRY & MINING CO.
Item No. 82597

1:20.3 Scale Narrow Gauge 4-4-0 American Steam Locomotive

Performs best on 8' diameter curves or greater.

Standard Pack: 1 • \$995.00

The 1876 Centennial Exhibition, which marked the 100th anniversary of our Nation's birth, was a showcase of the American spirit in industry and culture. Several locomotive manufacturers supplied motive power for the Exhibition's 3.5 mile passenger railroad, but a Baldwin 4-4-0 was the standout performer.

The Baldwin 4-4-0 went on to play a key role in the development and growth of U.S. narrow gauge railroads, and then served lines throughout the world. This style of locomotive was used more than any other in nearly every variety of service throughout the United States.

Features include:

- LED headlight
- polarity selector switch for operation according to NMRA standards or large scale model railroading practice
- smoke generator with on-off switch
- load-synchronized LEDs in firebox and ashpan for realistic fire glow
- precision can motor
- metal frame
- complete backhead detail
- fully operational Stephenson valve gear with operating piston valves, Johnson bar and linkage
- numerous separate detail parts
- metal handrails and piping
- prototypical, sprung axle bearings
- chemically blackened, machined metal wheels
- scale coupler pockets



PAINTED, UNLETTERED – LAKE & RUSSIA IRON
Item No. 81391



PAINTED, UNLETTERED – OLIVE GREEN & RUSSIA IRON
Item No. 81392

1:20.3 Scale Narrow Gauge 0-4-0 Side Tank Porter

(continued)



PAINTED, UNLETTERED – BLACK with RED & WHITE TRIM
Item No. 82598



PAINTED, UNLETTERED – BLACK
Item No. 82599

1:20.3 Scale Narrow Gauge Rail Truck

Performs best on 4' diameter curves or greater.

Standard Pack: 1 • \$400.00

Along with the financial devastation of the Great Depression, the Rio Grande Southern faced natural disaster as well when a mudslide cut the railroad into two pieces. A divided line severely reduced rail traffic, and the struggle to remain financially solvent in the face of these difficulties inspired the RGS to develop Motor Car #1, a cost-effective solution to severely reduced passenger and freight traffic. Based on the replica of Rio Grande Southern Motor #1 that resides in Colorado's Ridgeway Railroad Museum, our large scale *Rail Truck* brings whimsy and realism to narrow gauge modeling.

Features include:

- DCC ready
- powered by realistic drive-shaft
- die-cast frame, bed, and hood
- LED headlights and rear marker light
- full interior with seats and instrument panel



PAINTED, UNLETTERED – RED & BLACK
Item No. 82394



PAINTED, UNLETTERED – SILVER & BLACK
Item No. 82395



PAINTED, UNLETTERED – YELLOW & BLACK
Item No. 82397



PAINTED, UNLETTERED – BLACK
Item No. 82396



PAINTED, UNLETTERED – GREEN & BLACK
Item No. 82398



RIO GRANDE SOUTHERN #1
Item No. 82399

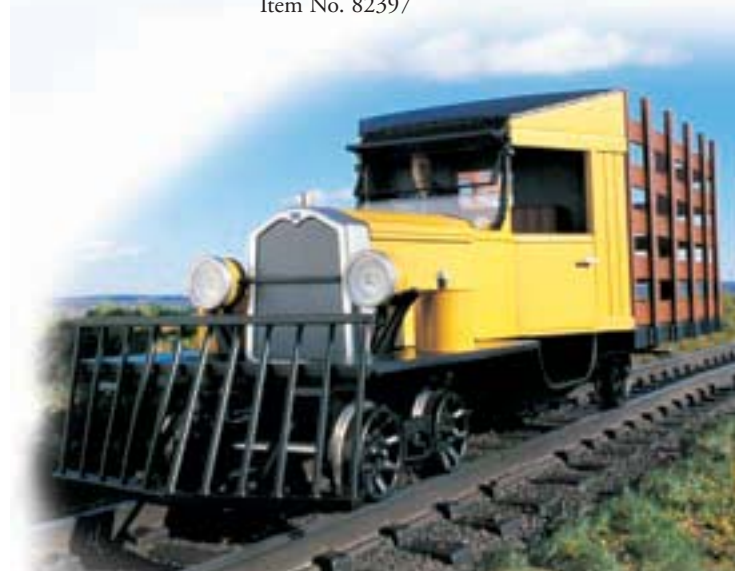

1:20.3 Narrow Gauge Rolling Stock

These Fn3 cars are excellent finescale companions to any locomotive on your Large Scale roster. Minimum 8' diameter curved track required.

Features include:

- finescale detailing
- metal wheels
- die-cast scale knuckle couplers (body-mounted coupler pockets for wide radius use only)
- offset shank couplers also included for use with other popular brands of narrow gauge couplers (1:22.5)



Low-Side Gondola (with opening side doors)

Performs best on 8' diameter curves or greater.

Standard Pack: 1 • \$180.00



PACIFIC COAST
Item No. 88296



FLORENCE & CRIPPLE CREEK
Item No. 88297



PAINTED, UNLETTERED - OXIDE RED
Item No. 88298



PAINTED, UNLETTERED - BROWN
Item No. 88299

1:20.3 Narrow Gauge Rolling Stock (continued)

Box Car

Performs best on 8' diameter curves or greater.

Standard Pack: 1 • \$225.00 each



SOUTHERN PACIFIC™
Item No. 88096



FLORENCE & CRIPPLE CREEK
Item No. 88097



PACIFIC COAST
Item No. 88098



PAINTED, UNLETTERED - OXIDE RED
Item No. 88099

1:20.3 Narrow Gauge Rolling Stock (continued)

Box Car with Murphy Roof

Performs best on 8' diameter curves or greater.

Standard Pack: 1 • \$225.00 each



COLORADO & SOUTHERN
Item No. 88695



DENVER & RIO GRANDE WESTERN™
Item No. 88696



FLORENCE & CRIPPLE CREEK
Item No. 88697



PAINTED, DATA ONLY - OXIDE RED
Item No. 88698



PAINTED, DATA ONLY - OXIDE BROWN
Item No. 88699

1:20.3 Narrow Gauge Rolling Stock (continued)

Frameless Tank Car

Performs best on 8' diameter curves or greater.

Standard Pack: 1 • \$240.00



GRAMPS
Item No. 88495



UTLX #11058
Item No. 88496



PAINTED, UNLETTERED - SILVER
Item No. 88498



PAINTED, UNLETTERED - OXIDE RED
Item No. 88499



Have a question? You can
"Ask the Bach-Man" on
our message board at
[www.bachmantrains.com!](http://www.bachmantrains.com)

1:20.3 Narrow Gauge Rolling Stock (continued)

Framed Tank Car

Performs best on 8' diameter curves or greater.

Standard Pack: 1 • \$240.00



WHITE PASS & YUKON #59
Item No. 88195



UTLX #13168
Item No. 88196



PAINTED, UNLETTERED - BLACK
Item No. 88197



PAINTED, UNLETTERED - SILVER
Item No. 88198



PAINTED, UNLETTERED - OXIDE RED
Item No. 88199

1:20.3 Narrow Gauge Rolling Stock (continued)

Flat Car

Performs best on 8' diameter curves or greater.

Standard Pack: 1 • \$120.00

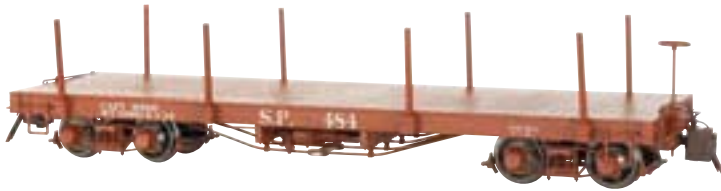

SOUTHERN PACIFIC™
Item No. 88396



DENVER & RIO GRANDE WESTERN™
Item No. 88397



PACIFIC COAST
Item No. 88398



PAINTED, UNLETTERED - BLACK
Item No. 88399

2-Bay Steel Hopper

Performs best on 8' diameter curves or greater.

Standard Pack: 1 • \$225.00



PAINTED, UNLETTERED - OXIDE RED
Item No. 88995



MIDWEST QUARRY & MINING
Item No. 88996



EAST BROAD TOP
Item No. 88997

1:20.3 Narrow Gauge Rolling Stock (continued)

Long Caboose

Performs best on 8' diameter curves or greater.

Standard Pack: 1 • \$315.00

We believe every train needs a caboose, and the remarkable detailing of our 1:20.3 Long Caboose makes it the perfect complement to any narrow gauge consist.

Features include:

- designed to operate on DC, DCC, or battery power layouts
- 8-pin socket for standard DCC decoder
- operating cupola windows (cupola style per prototype)
- removable roof
- lighted and detailed interior with bunks, seats, stove, piping, and simulated kerosene lamps
- blackened brass ladders
- die-cast caboose trucks with operating leaf springs
- metal wheels
- die-cast scale knuckle couplers (body-mounted coupler pockets for wide radius use only)
- offset shank couplers also included for use with other popular brands of narrow gauge couplers (1:22.5)
- two underside switches to choose battery, DC, or DCC operation and activation of table lights, marker lights, or both with center "off" position



DENVER & RIO GRANDE
WESTERN™ #0505
Item No. 88795



RIO GRANDE SOUTHERN™
with SINGLE WINDOW CUPOLA
Item No. 88796



RIO GRANDE™
"FLYING GRANDE"
Item No. 88797



PAINTED, UNLETTERED
OXIDE BROWN
Item No. 88798



PAINTED, UNLETTERED
OXIDE RED
Item No. 88799

1:20.3 Scale Accessories



STRAIGHT SHANK COUPLERS
(3 pairs per card)
Item No. 88011 • Standard Pack: 12
\$28.00



OFFSET SHANK COUPLERS
(3 pairs per card)
Item No. 88012 • Standard Pack: 12
\$28.00



COUPLER POCKETS with SCREWS
(4 pairs per card)
Item No. 88013 • Standard Pack: 12
\$7.50



K-27 SNOW PLOW
with **COUPLER & MOUNTING BRACKET**
Item No. 88014 • Standard Pack: 6
\$27.00



K-27 SWITCHER PILOT
Item No. 88015 • Standard Pack: 6
\$22.00



K-27 ROAD PILOT
Item No. 88016 • Standard Pack: 6
\$22.00



K-27 DOGHOUSE with INTERIOR
Item No. 88017 • Standard Pack: 6
\$25.00

NATIONAL SALES OFFICE

1400 East Erie Avenue
Philadelphia, PA 19124 USA
Telephone: 215-533-1600
Fax: 215-744-4699
www.bachmanntrains.com

UNITED KINGDOM

Bachmann Europe PLC.
Moat Way, Barwell
Leicestershire LE9 8EY
United Kingdom
Telephone: 44-1455-841756
Fax: 44-1455-841787
www.bachmann.co.uk

GERMANY

Bachmann Europe PLC.
Niederlassung Deutschland
Am Umspannwerk 5
D-90518 Altdorf Bei Nürnberg
Germany
Telephone: 49-9187-9722-0
Fax: 49-9187-9722-22
www.liliput.de



We strive to provide accurate information, but production issues sometimes occur that may alter the features of a particular item. Therefore, final product or pricing may vary from the information presented on these pages.

Thousands of Parts, in All Scales, Now Available Online

To order Bachmann parts from our Online Parts Catalog, visit the Parts & Service section of www.bachmanntrains.com and click on the "Order Parts" image. You can also contact the Parts Team at parts@bachmanntrains.com or call 1-800-356-3910 (within the United States) for more information.

If your Bachmann train product should need service, please contact our service department.

SERVICE DEPARTMENT

Bachmann Industries, Inc.
1400 East Erie Avenue
Philadelphia, Pennsylvania 19124

1-800-356-3910
service@bachmanntrains.com



Have a question? You can "Ask the Bach-Man" on our message board at www.bachmanntrains.com!