

GUARANTEED PRE-ORDER DUE DATE: WEDNESDAY MARCH 13TH, 2024
CONSUMER EDITION



ATLAS 100TH ANNIVERSARY CATALOG - VOLUME 1 N & HO SCALE - JAN. 2024

Atlas Guaranteed Pre-Order Announcements



**Atlas Master® SD-35 Locomotives
N Scale pg. 8-11; HO Scale pg. 26-29**

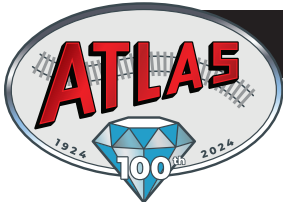

PRE-ORDER ANNOUNCEMENTS - JANUARY 2024

GUARANTEED PRE-ORDER DUE DATE: WEDNESDAY MARCH 13TH 2024

January 2023

Dear Model Railroader,

Atlas is celebrating the momentous occasion of our 100th Anniversary throughout 2024! Our year-long anniversary announcements begin with The Atlas 100th Anniversary Catalog, Volume 1. This edition of the All Scales Monthly Catalog (ASMC) is chock full of new announcements in N & HO scales. Stay tuned throughout the year for additional catalogs featuring all Atlas' offered scales!

The ASMC is the basis of the distinctive Atlas Guaranteed Pre-Order system. Before the Research & Development department gives the final go ahead for production, Atlas announces to its customers the products we are preparing to make. This announcement comes in the form of the ASMC that provides our customers with the opportunity to arrange a guaranteed pre-order if placed by the given deadline. If possible, Atlas will try to fill orders placed after the given "due date", but these can not be guaranteed.

The Atlas 100th Anniversary Catalog, Volume 1 edition includes announcements of prototypical N and HO locomotives including the SD-35 and the RS-11. We're also announcing plenty of prototype accurate rolling stock including N & HO scale 42' Coil Steel Cars and 40' Standard Height Containers. In HO, the highly sought after Thrall 2743 Gondolas and 2-Bay Offset Hoppers return to the lineup! Don't miss new paint schemes and road numbers offered in N scale on the PS-4427 Hoppers and Trainman 42' Gondolas.

While on the Atlas website, shop.atlasrr.com, be sure to peruse the "New Arrivals" pages to see what has recently arrived on Authorized Dealer shelves, or the In-Stock pages to see what is readily available from Atlas. Recently arrived and now available is Atlas' tried and true N scale True-Track, now with realistic gray roadbed! Take a look at the new roadbed color in the photos on the back cover of this catalog.

Need to do some track work? Atlas has all the pieces you need - from straights to switches and everything in between! Atlas can also help outfit you with a full layout package - check out page 24-25 for more information. We also offer a full line of instructional guides if you're looking to start fresh with a brand new layout! For a complete listing of our books, visit our website or inquire at your local hobby shop. For assistance finding an Atlas Authorized Dealer near you, use our handy Dealer locator at <https://shop.atlasrr.com/storelocator.aspx>.

Don't miss out on all of the latest Atlas news, announcements, special offers and more. You can ensure that you receive the latest Atlas news delivered to your inbox by visiting shop.atlasrr.com and signing up for our email newsletter - *the Atlas Insider*.

Thank you for your interest and enthusiasm in the exceptional multi-scale product offerings produced by Atlas Model Railroad Company.

Happy Modeling,

Drew Postle
Atlas Sales Manager

Products bearing American Refrigerator Transit; Chicago & Eastern Illinois (C&EI); Chicago and North Western Railway Company (CNW); The Denver & Rio Grande Western Railroad Company (D&RGW); Katy; Missouri-Kansas-Texas Railroad Company (MKT); Missouri Pacific (MP); Pacific Fruit Express (PFE); Southern Pacific (SP); St. Louis Southwestern Railway Company (SSW); Cotton Belt; Texas & Pacific (T&P); Union Pacific (UP); Union Pacific Fruit Express (UPFE); Western Pacific (WP) marks are made under trademark license from Union Pacific Railroad Company.



GUARANTEED PRE-ORDER DUE DATE: WEDNESDAY MARCH 13TH 2024

TABLE OF CONTENTS

ANNOUNCEMENTS

PAGE

N HO ATLAS HISTORY AND ANNIVERSARY

O Z 100 YEARS OF ATLAS HISTORY	pgs.4
ATLAS 100TH ANNIVERSARY LOCOMOTIVE & PHOTO CONTEST	pgs.5
ATLAS ARCHIVAL PHOTOGRAPHS	pgs.6-7

N SCALE N SCALE GUARANTEED PRE-ORDER ANNOUNCEMENTS

ATLAS MASTER® N SD-35 LOCOMOTIVE - <i>New Paint Schemes, New Road Numbers & Back by Popular Demand</i>	pgs.8-11
ATLAS CLASSIC® N RS-11 LOCOMOTIVE - <i>New Paint Schemes, New Road Numbers, 1st Time Offered with Sound</i>	pgs.12-15
ATLAS MASTER® N 42' COIL STEEL CAR - <i>New Paint Schemes & New Road Numbers</i>	pgs.16-17
ATLAS MASTER® N PS-4427 HOPPER - <i>All New Paint Schemes</i>	pgs.18-19
ATLAS MASTER® N 40' STANDARD HEIGHT CONTAINERS - <i>New Paint Schemes & New Road Numbers</i>	pgs.20-21
ATLAS TRAINMAN® N 42' GONDOLA - <i>New Paint Schemes</i>	pgs.22-23

N HO ATLAS INSTRUCTIONAL GUIDES AND SOFTWARE

O Z ATLAS ALL SCALE LAYOUT PACKAGES	pg. 24
ATLAS PARTS	pg. 25
ATLAS TRACK	pgs.42-43
ATLAS LOCOMOTIVES & ROLLING STOCK	pgs.44
ATLAS STRUCTURES & ACCESSORIES	pgs.45
ATLAS SIGNALS	pgs.46
	pgs.47

HO SCALE HO SCALE GUARANTEED PRE-ORDER ANNOUNCEMENTS

ATLAS MASTER® SD-35 LOCOMOTIVE - <i>New Paint Schemes, New Road Numbers & Back by Popular Demand</i>	pgs.26-29
ATLAS CLASSIC® HO RS-11 LOCOMOTIVE - <i>New Paint Schemes, New Road Numbers</i>	pgs.30-33
ATLAS MASTER® HO 42' COIL STEEL CAR - <i>New Paint Schemes & New Road Numbers</i>	pgs.34-35
ATLAS MASTER® HO THRALL GONDOLA - <i>New Paint Schemes & New Road Numbers</i>	pgs.36-37
ATLAS MASTER® HO 40' STANDARD HEIGHT CONTAINERS - <i>New Paint Schemes & New Road Numbers</i>	pgs.38-39
ATLAS TRAINMAN® 2-BAY OFFSET HOPPER - <i>New Paint Schemes & New Road Numbers</i>	pgs.40-41

To Order, Please Contact Your Authorized Atlas Dealer

All prices are in US dollars. Prices and dates are subject to change without notice. Atlas reserves the right to correct errors, change prices and modify designs without notice. Any product pricing errors and updates may be corrected at any time through notification of distributors, dealers and consumers on our website: shop.atlasrr.com.

© 2023 Atlas Model Railroad Co., Inc.

Atlas Model Railroad Co., Inc. • 378 Florence Ave., Hillside, NJ 07205 • USA • ph: 908-687-0880 • fax: 908-687-8857 • shop.atlasrr.com

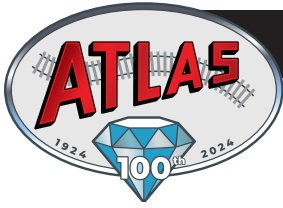

100 YEARS OF ATLAS HISTORY

Atlas Tool Company was founded by Stephan Schaffan Sr. in 1924 as a general machine shop in a small garage at 330 Waverly Avenue in Newark, New Jersey. His son, Stephan Schaffan Jr. joined him in the business in 1933. As a frequent visitor to the local hobby shop, he would often ask the owner if there was anything he could do to earn some extra spending money. Tired of listening to his requests, the hobby-store owner threw some model railroad track parts his way and said, "Here, see if you can improve on this".

In those days, railroad modelers had to assemble and build everything from scratch. Steve Jr. created a "switch kit" which sold so well, that the entire family worked on them in the basement at night, while doing business as usual in the machine shop during the day.

Not long after, Steve Jr.'s accomplishments include engineering the stapling of rail to fiber track, inventing the first practical rail joiner and pre-assembled turnouts and flexible track—all of which helped to popularize model railroading and assisted in the creation of a mass-market hobby. As the business grew, their manufacturing needs went beyond what the small garage could provide, so in 1947 Steve and his father had the first factory built in Hillside, New Jersey at 413 Florence Avenue. On September 30th, 1949, Atlas Tool Company Inc. was officially incorporated as a New Jersey company.

Over time Atlas, has expanded their product line to include much more than just track. At your local hobby store you can pick up Atlas track, locomotives, freight cars, signals, lighting and more in HO, N, O and even Z scale.

To mark the 100th anniversary of Atlas, we are publishing special edition Anniversary Catalogs throughout 2024. This catalog, featuring HO & N scale products is Volume 1 of our Anniversary Collection. Stay tuned to our website and social media pages for future Anniversary Catalog releases and other exciting news that we have planned to mark 100 years of Atlas quality and innovation!

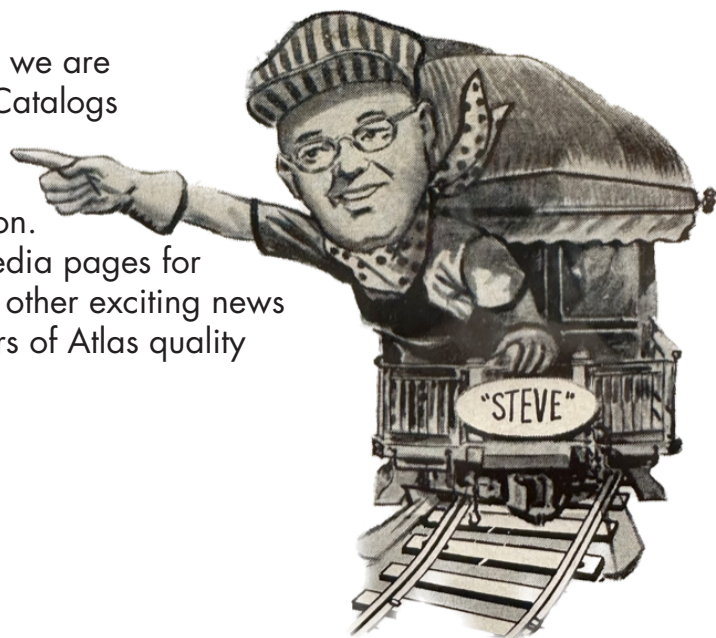



PRE-ORDER ANNOUNCEMENTS - JANUARY 2024

GUARANTEED PRE-ORDER DUE DATE: WEDNESDAY MARCH 13TH 2024

ATLAS 100 YEAR ANNIVERSARY ENGINE

We recently announced ALP-45DP locomotives and Bombardier passenger car models decorated in special 100th anniversary paint schemes that celebrate our long history. What makes it even more memorable is that residents and visitors in the New Jersey area can now see an actual locomotive wearing the Atlas 100 anniversary scheme thanks to our partnership with NJ TRANSIT. NJ TRANSIT #4503 has been wrapped with our commemorative 100 anniversary artwork, and is now in service on select NJ Transit routes.



Note: The guaranteed pre-order period for these models has closed. However, we will continue to accept orders and will fulfill as many as possible but these can not be guaranteed.

To celebrate the release of NJ TRANSIT #4503 in Atlas' 100th Anniversary paint scheme, a contest was held for eagle eyed railfans who spotted the locomotive on the rails! We received so many fantastic photo submissions that it was hard to choose the best. The 1st, 2nd and 3rd place winners are shown below! See these photos and more on our social media pages and website, shop.atlasrr.com

1st Place Winner
908 Drone Photography
Photo Taken in
Lebanon, NJ
(below left)



2nd Place Winner
Adam Reich
Photo Taken in
Cranford, NJ
(below right)

3rd Place Winner
Cody Booker
Photo Taken in
Newark, NJ
(below right)





PRE-ORDER ANNOUNCEMENTS - JANUARY 2024

GUARANTEED PRE-ORDER DUE DATE: WEDNESDAY MARCH 13TH 2024

ATLAS ARCHIVAL PHOTOGRAPHS



Stephan J. Schaffan Sr., shortly after immigrating from Czechoslovakia in the early 1900's, working on a rail crew on the East coast.

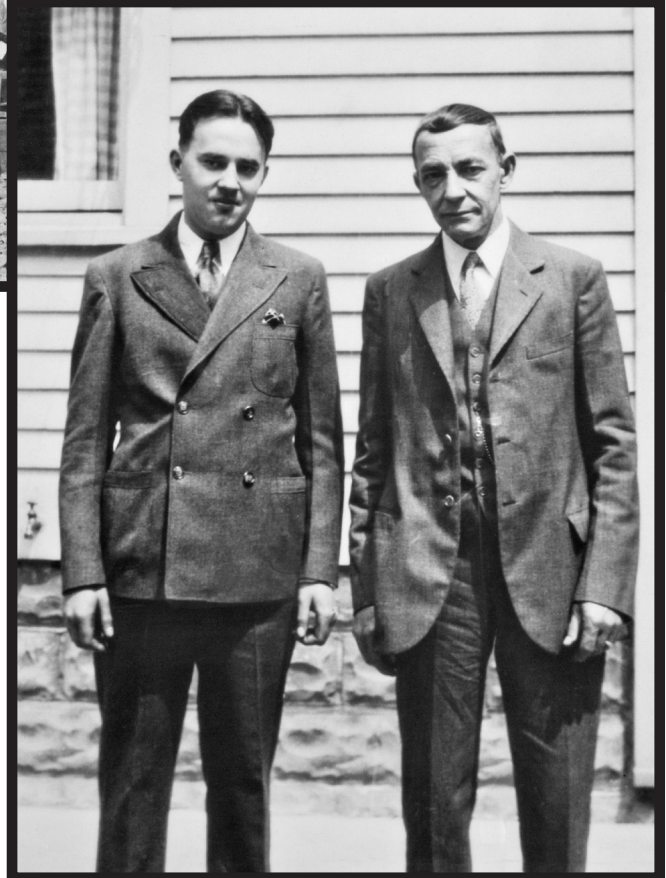

The founder of Atlas Tool Co., Stephan J. Schaffan Sr. (right), with his son Stephan J. Schaffan Jr., circa 1940.



Stephan J. Schaffan Sr. oversees the construction of the first Atlas track factory in Hillside NJ.

Atlas packaging, circa 1950

ATLAS TOOL CO., INC. HILLSIDE, N. J.

ATLAS

Ideal for:

- Terminals
- Yard Operations
- Car Storage
- Sidings, Etc.

SEE END FOR CONTENTS CONTAINED IN THIS PACKAGE

A PRECISION BUILT "HO" PRODUCT

COMPLETELY ASSEMBLED

3 SWITCH LADDER



GUARANTEED PRE-ORDER DUE DATE: WEDNESDAY MARCH 13TH 2024

ATLAS ARCHIVAL PHOTOGRAPHS

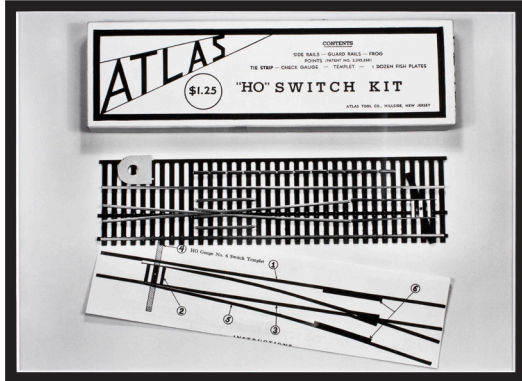

Early prototype of the Atlas HO Switch Kit



First Atlas track factory at 413 Florence Ave., Hillside, NJ. Completed 1947



Steve Jr. greets good friend Irv Athearn at the original Hillside location, 1950.



3rd & 4th Generation Atlas Family Owners & Operators-
Seated-Thomas W. Haedrich, Diane Schaffan Haedrich.
Standing, Jesse Schaffan Haedrich, left, Jarrett Schaffan Haedrich, right.

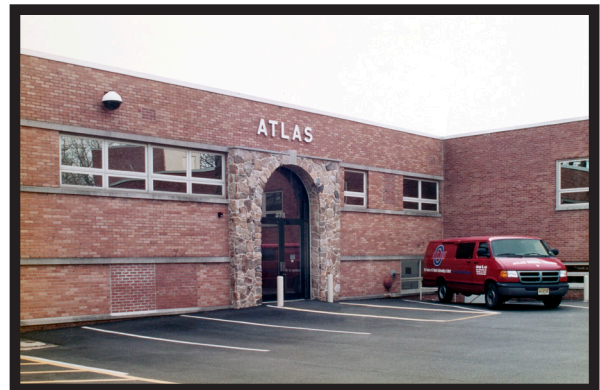

Front view of the Atlas Headquarters at 378 Florence Ave. in Hillside, NJ - 1959 (left), Present Day (right)



PRE-ORDER ANNOUNCEMENTS - JANUARY 2024

GUARANTEED PRE-ORDER DUE DATE: WEDNESDAY MARCH 13TH 2024

N
SCALE

ATLAS MASTER[®] N SD-35 LOCOMOTIVE

Product Info: <https://shop.atlasrr.com/d-715-100th-anniversary-catalog-1-n.aspx>

SILVER MODELS:
SOUND READY***

GOLD MODELS:
SOUND-EQUIPPED**

NEW
PAINT
SCHEMES



Cargill



CSX*



Montana Rail Link

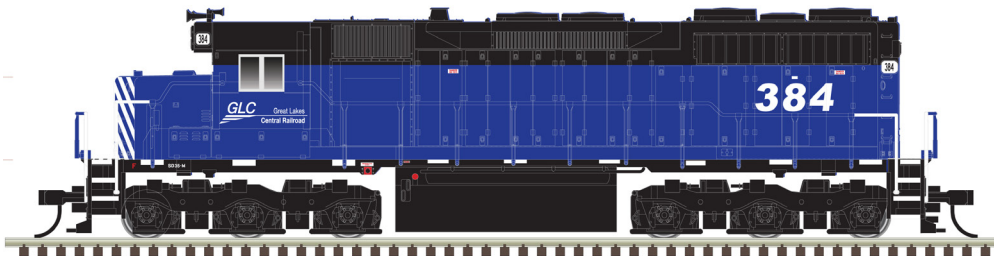

Great Lakes Central

*CSX Licensed Product

Atlas Model Railroad Co., Inc. • 378 Florence Ave., Hillside, NJ 07205 • USA • ph: 908-687-0880 • fax: 908-687-8857 • shop.atlasrr.com



PRE-ORDER ANNOUNCEMENTS - JANUARY 2024

GUARANTEED PRE-ORDER DUE DATE: WEDNESDAY MARCH 13TH 2024



ATLAS MASTER[®] N SD-35 LOCOMOTIVE

Back By Popular Demand



Guilford

NEW ROAD NUMBERS

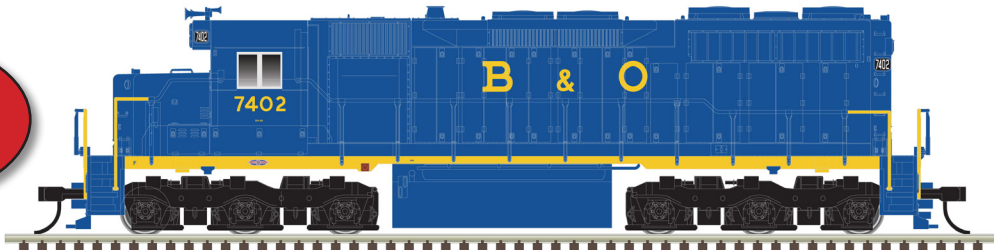

Baltimore & Ohio*

Southern Pacific models will feature new tooling for the nose light detail.

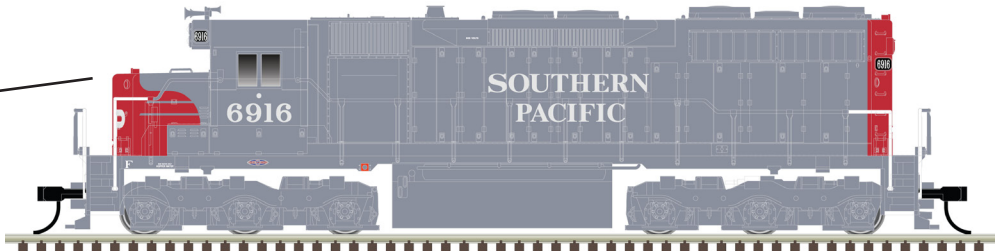

Southern Pacific

*****Silver Sound Ready™**
Atlas Silver Sound Ready models are equipped with a speaker for easy conversion to sound with the addition of a decoder. If you need assistance with the upgrade of a Sound Ready model, please contact Atlas Customer Service at 908-687-0880 or csdept@atlasrr.com



Southern



Silver Sound Ready™

Wired speaker and enclosure included for easy conversion to sound.

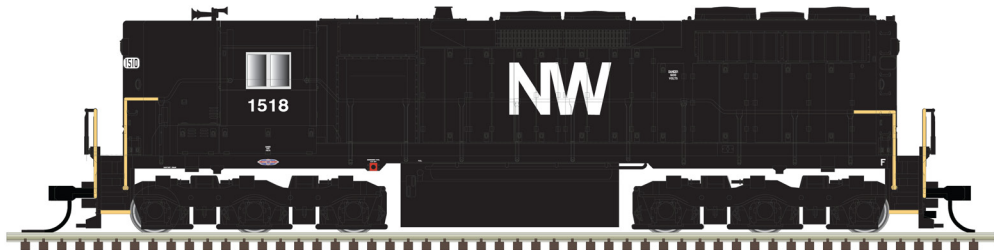

Norfolk & Western



**Gold Models with ESU Sound



PRE-ORDER ANNOUNCEMENTS - JANUARY 2024

GUARANTEED PRE-ORDER DUE DATE: WEDNESDAY MARCH 13TH 2024



ATLAS MASTER® N SD-35 LOCOMOTIVE

**SILVER MODELS:
SOUND READY*****

Product Info: <https://shop.atlasrr.com/d-715-100th-anniversary-catalog-1-n.aspx>

ESTIMATED ARRIVAL: 4th Quarter 2024 Arrival

ORDER IN PIECES	SILVER ITEM	ROAD NAME	ROAD #	COLOR	MSRP/ UNIT
SD-35 LOW NOSE LOCOMOTIVE NEW PAINT SCHEME					
	40 005 753	Cargill	606	Green/White	\$134.95
NEW ROAD NUMBERS					
	40 005 754	Baltimore & Ohio*	7402	Blue/Yellow	\$134.95
	40 005 755	Baltimore & Ohio*	7419	Blue/Yellow	\$134.95
NEW PAINT SCHEME					
	40 005 756	CSX*	4519	Gray/Blue	\$134.95
	40 005 757	CSX*	4525	Gray/Blue	\$134.95
BACK BY POPULAR DEMAND					
	40 005 758	Guilford	614	Gray/Orange/White	\$134.95
NEW PAINT SCHEMES					
	40 005 759	Montana Rail Link	701	Blue/Black	\$134.95
	40 005 760	Montana Rail Link	702	Blue/Black	\$134.95
	40 005 761	Great Lakes Central	384	Blue/Black	\$134.95
	40 005 762	Great Lakes Central	386	Blue/Black	\$134.95
NEW ROAD NUMBERS					
	40 005 763	Southern Pacific	6909	Gray/Red	\$134.95
	40 005 764	Southern Pacific	6916	Gray/Red	\$134.95
SD-35 HIGH NOSE LOCOMOTIVE NEW ROAD NUMBERS					
	40 005 765	Southern	3006	Black/White	\$134.95
	40 005 766	Southern	3030	Black/White	\$134.95
	40 005 767	Norfolk & Western	1504	Black/White	\$134.95
	40 005 768	Norfolk & Western	1518	Black/White	\$134.95
TOTAL PIECES ORDERED					

**CSX Licensed Product*

Between 1964 and 1966, EMD built a total of 360 six-axle 2,500hp SD35 locomotives. From the mid-1960s through the 1980s, the SD-35 could be found in road service on both large and mid-sized roads across the US. Today the number of active units has dwindled to a select few, including those operated by regional railroad Montana Rail Link. Atlas' model incorporates many of the subtle details that differentiated the various SD-35 production phases. This includes the detail of the engine air intake, dust bin, radiator screens, radiator fans, fuel tanks and battery boxes.

Features:

- Realistic die-cast underframe
- Five-pole skewed armature motor with dual flywheels for optimum performance at all speeds
- Golden-white LEDs
- Directional lighting
- Factory-equipped with AccuMate® knuckle couplers
- Detailed cab interior with crew
- Separately-installed scale windshield wipers, metal grab irons and fine scale handrails
- Marker lights with separate lenses
- Scale fans and grille detail
- Flat dust bin or raised dust bin as appropriate by railroad
- Snowplow (included but not installed)



**Silver
Sound Ready™**

Wired speaker and enclosure included for easy conversion to sound.

*****Silver Sound Ready™**

Atlas Silver Sound Ready models are equipped with a speaker for easy conversion to sound with the addition of a decoder. If you need assistance with the upgrade of a Sound Ready model, please contact Atlas Customer Service at 908-687-0880 or csdept@atlasrr.com

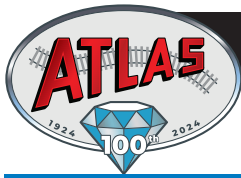

PRE-ORDER ANNOUNCEMENTS - JANUARY 2024

GUARANTEED PRE-ORDER DUE DATE: WEDNESDAY MARCH 13TH 2024



ATLAS MASTER® N SD-35 LOCOMOTIVE

**GOLD MODELS:
SOUND-EQUIPPED****

Product Info: <https://shop.atlasrr.com/d-715-100th-anniversary-catalog-1-n.aspx>

ESTIMATED ARRIVAL: 4th Quarter 2024 Arrival

ORDER IN PIECES	GOLD ITEM	ROAD NAME	ROAD #	COLOR	MSRP/ UNIT
SD-35 LOW NOSE LOCOMOTIVE					
NEW PAINT SCHEME					
	40 005 769	Cargill	606	Green/White	\$249.95
NEW ROAD NUMBERS					
	40 005 770	Baltimore & Ohio*	7402	Blue/Yellow	\$249.95
	40 005 771	Baltimore & Ohio*	7419	Blue/Yellow	\$249.95
NEW PAINT SCHEME					
	40 005 772	CSX*	4519	Gray/Blue	\$249.95
	40 005 773	CSX*	4525	Gray/Blue	\$249.95
BACK BY POPULAR DEMAND					
	40 005 774	Guilford	614	Gray/Orange/White	\$249.95
NEW PAINT SCHEMES					
	40 005 775	Montana Rail Link	701	Blue/Black	\$249.95
	40 005 776	Montana Rail Link	702	Blue/Black	\$249.95
	40 005 777	Great Lakes Central	384	Blue/Black	\$249.95
	40 005 778	Great Lakes Central	386	Blue/Black	\$249.95
NEW ROAD NUMBERS					
	40 005 779	Southern Pacific	6909	Gray/Red	\$249.95
	40 005 780	Southern Pacific	6916	Gray/Red	\$249.95
SD-35 HIGH NOSE LOCOMOTIVE					
NEW ROAD NUMBERS					
	40 005 781	Southern	3006	Black/White	\$249.95
	40 005 782	Southern	3030	Black/White	\$249.95
	40 005 783	Norfolk & Western	1504	Black/White	\$249.95
	40 005 784	Norfolk & Western	1518	Black/White	\$249.95
TOTAL PIECES ORDERED					

**CSX Licensed Product*

SILVER SOUND READY FEATURES (SILVER LOCOMOTIVES ONLY):

- Sound ready & equipped with speaker for easy conversion to DCC sound.

DCC OPERATION FEATURES (GOLD LOCOMOTIVES ONLY):

- Supports all DCC-programming modes; DCC includes RailCom and RailComPlus, with 14, 28 or 128 speed steps and with 2-digit and 4-digit addressing.
- Flexible mapping of function keys F0 to F28.
- A total of 6 DCC function outputs are available, and all can be function mapped (disable, brightness, light effects) individually
- Follows all NMRA DCC standards and recommended practices.

SOUND FUNCTIONALITY FEATURES (GOLD LOCOMOTIVES ONLY):

- Over 20 sound effects are available, including engine start-up and shutdown, prime mover sounds through all eight notches, bell, air horn, air compressor, dynamic brakes and more.
- There are up to 16 user-selectable horns, 2 user-selectable bells, and 2 user-selectable synchronized brake squeals.
- Equipped with ESU's Exclusive "Full Throttle" features for ultimate realism in prototype running.



****Gold Models
with ESU Sound**



PRE-ORDER ANNOUNCEMENTS - JANUARY 2024

GUARANTEED PRE-ORDER DUE DATE: WEDNESDAY MARCH 13TH 2024



ATLAS CLASSIC® N RS-11 LOCOMOTIVE

Product Info: <https://shop.atlasrr.com/d-715-100th-anniversary-catalog-1-n.aspx>

SILVER MODELS:
SOUND READY***

1st Time with Sound!

GOLD MODELS:
SOUND-EQUIPPED**

NEW
PAINT
SCHEMES

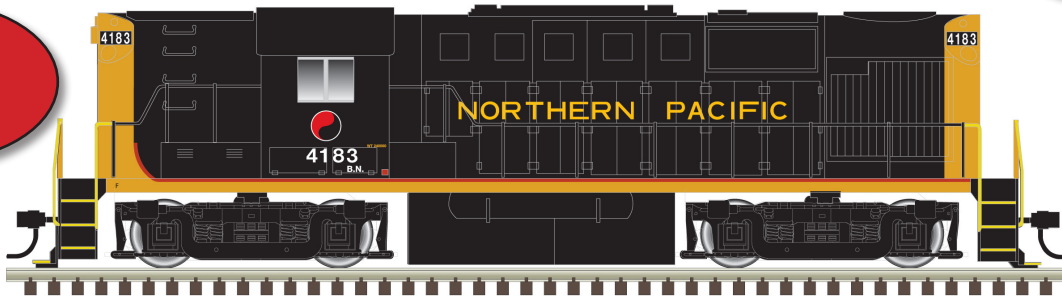

Burlington Northern (Northern Pacific patch)

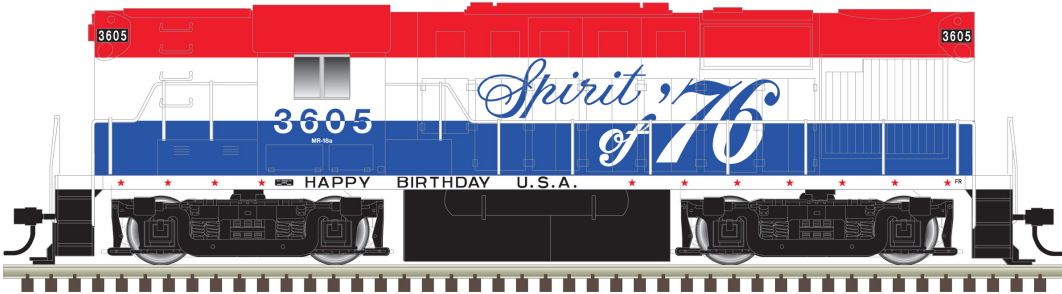

Duluth, Winnipeg & Pacific (DWP) Bicentennial

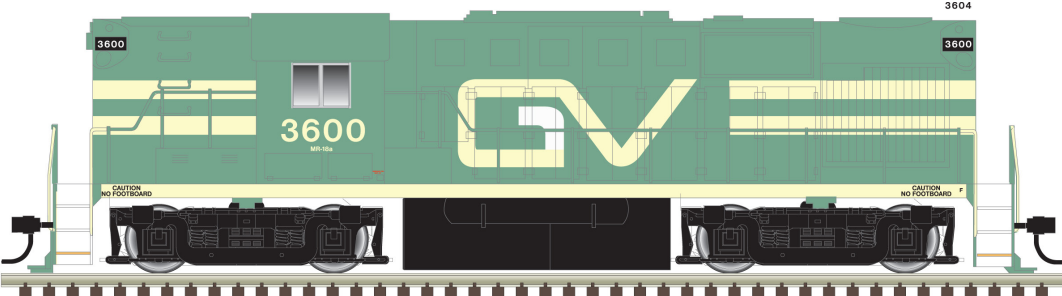

Genessee Valley



Ferrocarril del Pacifico

*CSX Licensed Product

Atlas Model Railroad Co., Inc. • 378 Florence Ave., Hillside, NJ 07205 • USA • ph: 908-687-0880 • fax: 908-687-8857 • shop.atlasrr.com



PRE-ORDER ANNOUNCEMENTS - JANUARY 2024

GUARANTEED PRE-ORDER DUE DATE: WEDNESDAY MARCH 13TH 2024



ATLAS CLASSIC® N RS-11 LOCOMOTIVE

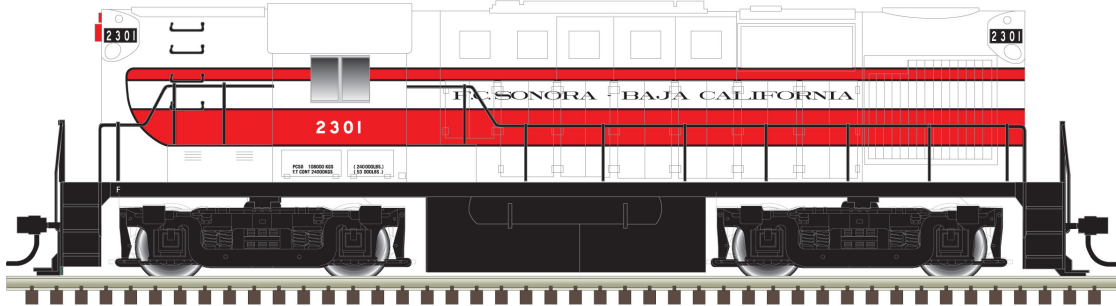

Sonora Baja California

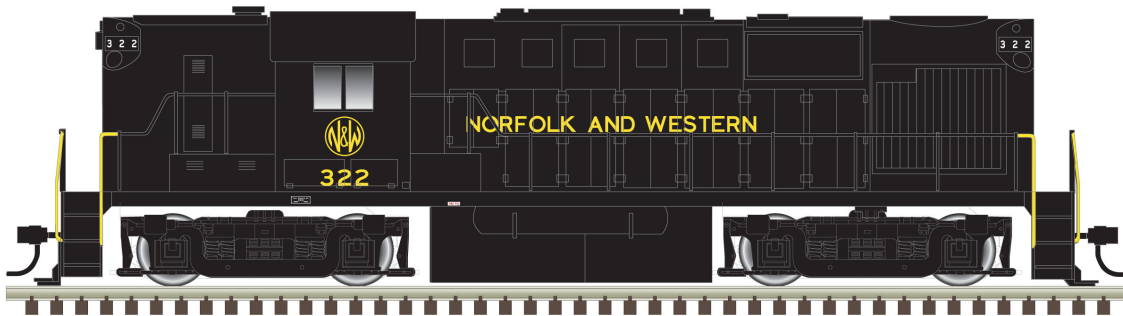

Norfolk & Western

**NEW
ROAD
NUMBERS**

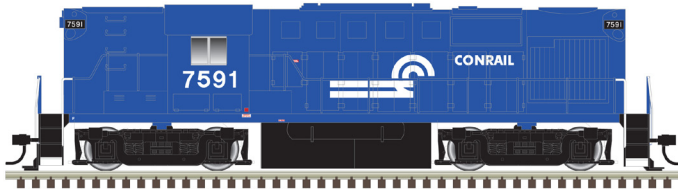

Conrail



Lehigh Valley

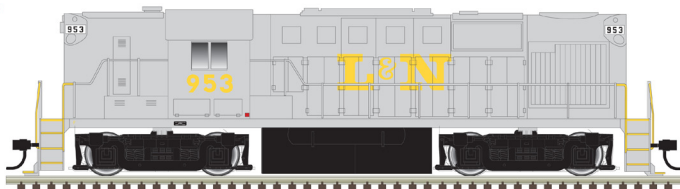

Louisville & Nashville*

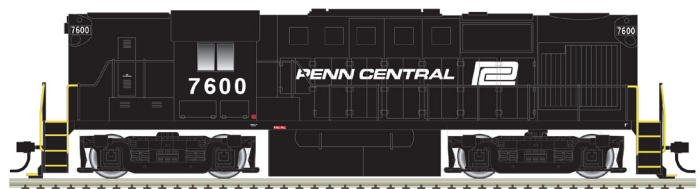

Penn Central



**Silver
Sound Ready™**

Wired speaker and enclosure included for easy conversion to sound.

***Silver Sound Ready™

Atlas Silver Sound Ready models are equipped with a speaker for easy conversion to sound with the addition of a decoder. If you need assistance with the upgrade of a Sound Ready model, please contact Atlas Customer Service at 908-687-0880 or csdept@atlasrr.com

Atlas Model Railroad Co., Inc. • 378 Florence Ave., Hillside, NJ 07205 • USA • ph: 908-687-0880 • fax: 908-687-8857 • shop.atlasrr.com

*CSX Licensed Product



**Gold Models
with ESU Sound



PRE-ORDER ANNOUNCEMENTS - JANUARY 2024

GUARANTEED PRE-ORDER DUE DATE: WEDNESDAY MARCH 13TH 2024



ATLAS CLASSIC® N RS-11 LOCOMOTIVE

**SILVER MODELS:
SOUND READY*****

Product Info: <https://shop.atlasrr.com/d-715-100th-anniversary-catalog-1-n.aspx>

ESTIMATED ARRIVAL: 4th Quarter 2024 Arrival

ORDER IN PIECES	SILVER ITEM	ROAD NAME	ROAD #	COLOR	MSRP/ UNIT
NEW PAINT SCHEMES					
	40 005 865	Burlington Northern (Northern Pacific patch)	4180	Black/Orange/Red	\$134.95
	40 005 866	Burlington Northern (Northern Pacific patch)	4183	Black/Orange/Red	\$134.95
NEW ROAD NUMBERS					
	40 005 867	Conrail	7591	Blue/White	\$134.95
	40 005 868	Conrail	7598	Blue/White	\$134.95
NEW PAINT SCHEMES					
	40 005 869	Duluth, Winnipeg & Pacific (DWP) WP Bicentennial	3605	Red/White/Blue	\$134.95
	40 005 870	Genessee Valley	3600	Green/Yellow	\$134.95
	40 005 871	Genessee Valley	3604	Green/Yellow	\$134.95
	40 005 872	Ferrocarril del Pacifico	501	Yellow/Blue	\$134.95
	40 005 873	Sonora Baja California	2301	Red/White	\$134.95
	40 005 874	Norfolk and Western	322	Black/White	\$134.95
	40 005 875	Norfolk and Western	327	Black/White	\$134.95
NEW ROAD NUMBERS					
	40 005 876	Lehigh Valley	7640	Maroon/Gold	\$134.95
	40 005 877	Lehigh Valley	7643	Maroon/Gold	\$134.95
	40 005 878	Louisville & Nashville*	953	Gray/Yellow	\$134.95
	40 005 879	Louisville & Nashville*	958	Gray/Yellow	\$134.95
	40 005 880	Penn Central	7600	Black/White	\$134.95
	40 005 881	Penn Central	7604	Black/White	\$134.95
TOTAL PIECES ORDERED					

The first RS-11s were produced by Alco in early 1956. This locomotive, classified by Alco as model DL-701, was their replacement for the very popular RS-3 road-switcher. Featuring a V-12, 1,800hp 251B diesel engine, the RS-11 was Alco's answer to EMD's very successful GP9. The turbocharged RS-11 accelerated faster, had a higher tractive effort rating and typically used less fuel than the competition. It was also quite versatile and could be found in heavy haul freight as well as passenger service.

The largest owner of RS-11s was Norfolk & Western which purchased a total of 99 units (an additional 35 were added to the fleet after the merger with Nickel Plate). Other major purchasers included Northern Pacific, Pennsylvania and Southern Pacific, all of whom placed repeat orders. With approximately 426 units built for the US and Mexico over 8 years of production, the RS-11 was successful for Alco in that it provided ongoing competition for EMD's popular road-switchers. A few examples of this model are still in service today and can be found working for various shortlines in the US.

Features:

- Full pilots
- AccuMate® couplers
- Golden-white LEDs
- Separate handrails and side sill
- Correct wheelbase

SILVER SOUND READY FEATURES (SILVER LOCOMOTIVES ONLY):

- Sound ready & equipped with speaker for easy conversion to DCC sound.



**Silver
Sound Ready™**

Wired speaker and enclosure included for easy conversion to sound.

*****Silver Sound Ready™**

Atlas Silver Sound Ready models are equipped with a speaker for easy conversion to sound with the addition of a decoder. If you need assistance with the upgrade of a Sound Ready model, please contact Atlas Customer Service at 908-687-0880 or csdept@atlasrr.com

**CSX Licensed Product*



PRE-ORDER ANNOUNCEMENTS - JANUARY 2024

GUARANTEED PRE-ORDER DUE DATE: WEDNESDAY MARCH 13TH 2024



ATLAS CLASSIC® N RS-11 LOCOMOTIVE

**GOLD MODELS:
SOUND-EQUIPPED****

Product Info: <https://shop.atlasrr.com/d-715-100th-anniversary-catalog-1-n.aspx>

ESTIMATED ARRIVAL: 4th Quarter 2024 Arrival

ORDER IN PIECES	GOLD ITEM	ROAD NAME	ROAD #	COLOR	MSRP / UNIT
NEW PAINT SCHEMES					
	40 005 882	Burlington Northern (Northern Pacific patch)	4180	Black/Orange/Red	\$249.95
	40 005 883	Burlington Northern (Northern Pacific patch)	4183	Black/Orange/Red	\$249.95
NEW ROAD NUMBERS					
	40 005 884	Conrail	7591	Blue/White	\$249.95
	40 005 885	Conrail	7598	Blue/White	\$249.95
NEW PAINT SCHEMES					
	40 005 886	Duluth, Winnipeg & Pacific (DWP) WP Bicentennial	3605	Red/White/Blue	\$249.95
	40 005 887	Genessee Valley	3600	Green/Yellow	\$249.95
	40 005 888	Genessee Valley	3604	Green/Yellow	\$249.95
	40 005 889	Ferrocarril del Pacifico	501	Yellow/Blue	\$249.95
	40 005 890	Sonora Baja California	2301	Red/White	\$249.95
	40 005 891	Norfolk and Western	322	Black/White	\$249.95
	40 005 892	Norfolk and Western	327	Black/White	\$249.95
NEW ROAD NUMBERS					
	40 005 893	Lehigh Valley	7640	Maroon/Gold	\$249.95
	40 005 894	Lehigh Valley	7643	Maroon/Gold	\$249.95
	40 005 895	Louisville & Nashville*	953	Gray/Yellow	\$249.95
	40 005 896	Louisville & Nashville*	958	Gray/Yellow	\$249.95
	40 005 897	Penn Central	7600	Black/White	\$249.95
	40 005 898	Penn Central	7604	Black/White	\$249.95
TOTAL PIECES ORDERED					

DCC OPERATION FEATURES (GOLD LOCOMOTIVES ONLY):

- Supports all DCC-programming modes; DCC includes RailCom and RailComPlus, with 14, 28 or 128 speed steps and with 2-digit and 4-digit addressing.
- Flexible mapping of function keys F0 to F28.
- A total of 6 DCC function outputs are available, and all can be function mapped (disable, brightness, light effects) individually
- Follows all NMRA DCC standards and recommended practices.

SOUND FUNCTIONALITY FEATURES (GOLD LOCOMOTIVES ONLY):

- Over 20 sound effects are available, including engine start-up and shutdown, prime mover sounds through all eight notches, bell, air horn, air compressor, dynamic brakes and more.
- There are up to 16 user-selectable horns, 2 user-selectable bells, and 2 user-selectable synchronized brake squeals.
- Equipped with ESU's Exclusive "Full Throttle" features for ultimate realism in prototype running.

AccuMate® couplers are made under license from AccuRail, Inc.

1st Time with Sound!

*CSX Licensed Product



**Gold Models
with ESU Sound



PRE-ORDER ANNOUNCEMENTS - JANUARY 2024

GUARANTEED PRE-ORDER DUE DATE: WEDNESDAY MARCH 13TH 2024



ATLAS MASTER[®] N 42' COIL STEEL CAR

Product Info: <https://shop.atlasrr.com/d-715-100th-anniversary-catalog-1-n.aspx>

NEW
PAINT
SCHEMES

NEW
ROAD
NUMBERS

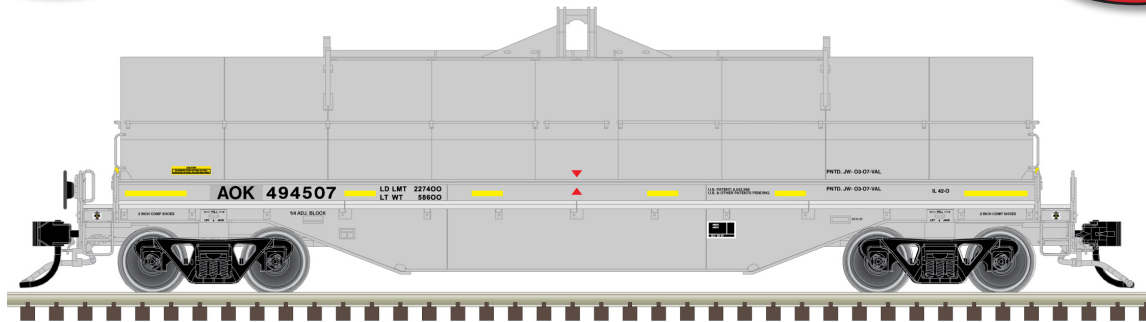

AOK (ex-CSXT)

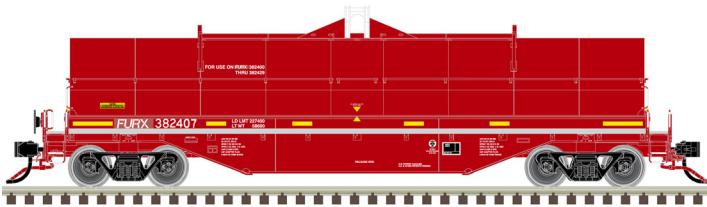

FURX (ex-NOKL)

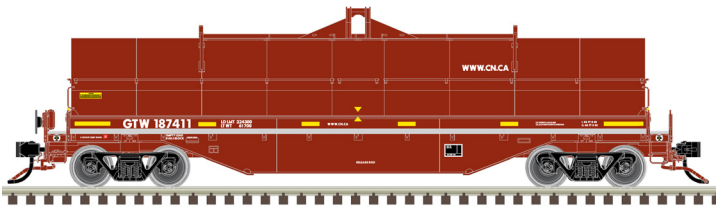

Grand Trunk Western (GTW) (CN web address)

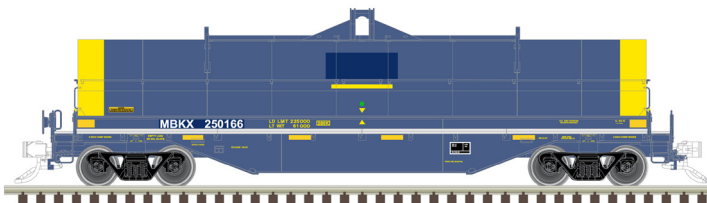

Mitsui Rail Capital (MBKX)

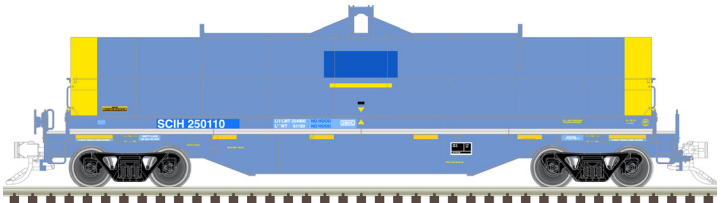

South Chicago & Indiana Harbor (SCIH)

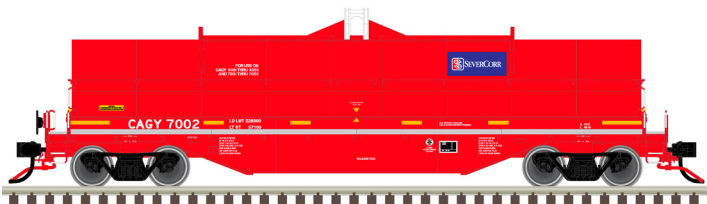

CAGY (ServerCorr)

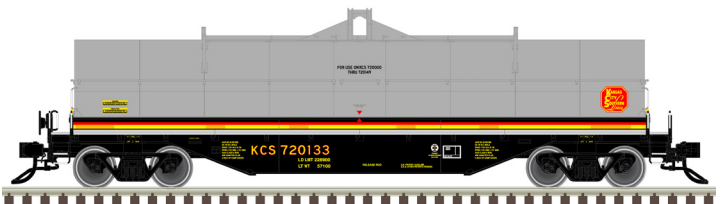

Kansas City Southern (KCS)



PRE-ORDER ANNOUNCEMENTS - JANUARY 2024

GUARANTEED PRE-ORDER DUE DATE: WEDNESDAY MARCH 13TH 2024



ATLAS MASTER® N 42' COIL STEEL CAR

ESTIMATED ARRIVAL: 3rd Quarter 2024 Arrival

ORDER IN PIECES	ITEM	ROAD NAME	ROAD #	COLOR	MSRP/ UNIT
NEW PAINT SCHEMES					
	50 006 760	AOK (ex-CSXT)	494507	Gray/Black/Yellow	\$36.95
	50 006 761	AOK (ex-CSXT)	494502	Gray/Black/Yellow	\$36.95
	50 006 762	AOK (ex-CSXT)	494606	Gray/Black/Yellow	\$36.95
	50 006 763	AOK (ex-CSXT)	494621	Gray/Black/Yellow	\$36.95
	50 006 764	FURX (ex-NOKL)	382407	Red/White/Yellow	\$36.95
	50 006 765	FURX (ex-NOKL)	382411	Red/White/Yellow	\$36.95
	50 006 766	FURX (ex-NOKL)	382420	Red/White/Yellow	\$36.95
	50 006 767	FURX (ex-NOKL)	382426	Red/White/Yellow	\$36.95
	50 006 768	Grand Trunk Western (GTW) (CN web address)	187411	Brown/White/Yellow	\$36.95
	50 006 769	Grand Trunk Western (GTW) (CN web address)	187441	Brown/White/Yellow	\$36.95
	50 006 770	Grand Trunk Western (GTW) (CN web address)	187482	Brown/White/Yellow	\$36.95
	50 006 771	Grand Trunk Western (GTW) (CN web address)	187526	Brown/White/Yellow	\$36.95
	50 006 772	Mitsui Rail Capital (MBKX)	250114	Blue/Yellow	\$36.95
	50 006 773	Mitsui Rail Capital (MBKX)	250166	Blue/Yellow	\$36.95
	50 006 774	South Chicago & Indiana Harbor (SCIH)	250110	Blue/Yellow	\$36.95
	50 006 775	South Chicago & Indiana Harbor (SCIH)	250215	Blue/Yellow	\$36.95
NEW ROAD NUMBERS					
	50 006 776	CAGY (ServerCorr)	7002	Red/Blue/White	\$36.95
	50 006 777	CAGY (ServerCorr)	7008	Red/Blue/White	\$36.95
	50 006 778	CAGY (ServerCorr)	7010	Red/Blue/White	\$36.95
	50 006 779	CAGY (ServerCorr)	7032	Red/Blue/White	\$36.95
	50 006 780	Kansas City Southern (KCS)	720017	Gray/Black/Red/Yellow	\$36.95
	50 006 781	Kansas City Southern (KCS)	720023	Gray/Black/Red/Yellow	\$36.95
	50 006 782	Kansas City Southern (KCS)	720048	Gray/Black/Red/Yellow	\$36.95
	50 006 783	Kansas City Southern (KCS)	720133	Gray/Black/Red/Yellow	\$36.95
TOTAL PIECES ORDERED					

The increased volume of coiled steel transportation gave rise to a new purpose-built freight car. Previously rolls of coiled-steel had generally traveled in specially equipped gondola cars. In the 1960's a lighter type of car emerged specifically for hauling coils of steel in an integral trough. The car type gained popularity and eventually over 17,000 cars were built. Atlas' model replicates a 42' design with a distinctive fishbelly side sill.

Features:

- Crisp painting and lettering
- See-through walks
- Removable hood
- Inside floor detail



PRE-ORDER ANNOUNCEMENTS - JANUARY 2024

GUARANTEED PRE-ORDER DUE DATE: WEDNESDAY MARCH 13TH 2024



ATLAS MASTER® N PS-4427 HOPPER

Product Info: <https://shop.atlasrr.com/d-715-100th-anniversary-catalog-1-n.aspx>

ALL NEW
PAINT
SCHEMES

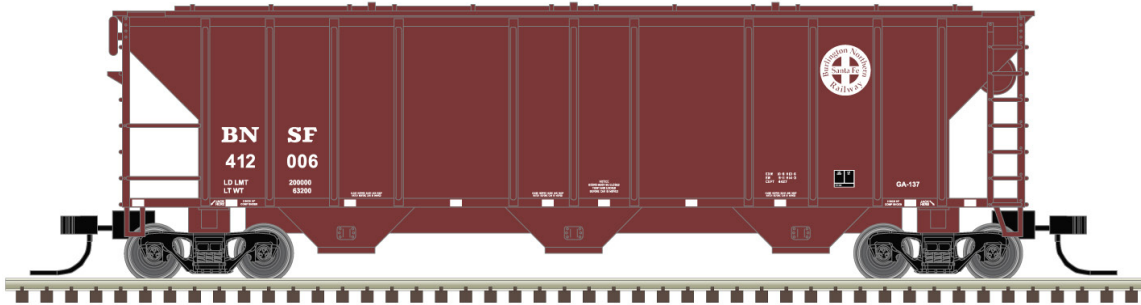

BNSF

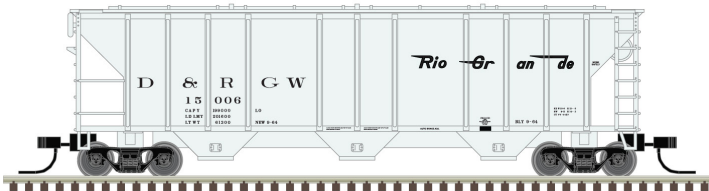

Rio Grande (DRGW)



Farmrail (GNBC) (Teal)

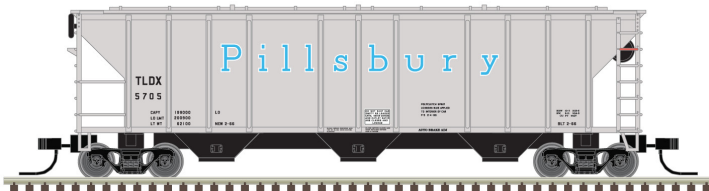

Pillsbury (TLDX)



Cargill (TLDX)



Louis Dreyfus (TLDX)



Garvey (GELX)



PRE-ORDER ANNOUNCEMENTS - JANUARY 2024

GUARANTEED PRE-ORDER DUE DATE: WEDNESDAY MARCH 13TH 2024



ATLAS MASTER® N PS-4427 HOPPER

ESTIMATED ARRIVAL: 3rd Quarter 2024 Arrival

ORDER IN PIECES	ITEM	ROAD NAME	ROAD #	COLOR	MSRP / UNIT
ALL NEW PAINT SCHEMES					
	50 006 784	BNSF	412006	Brown/White	\$33.95
	50 006 785	BNSF	412122	Brown/White	\$33.95
	50 006 786	BNSF	412264	Brown/White	\$33.95
	50 006 787	Rio Grande (DRGW)	15006	Gray/Black	\$33.95
	50 006 788	Rio Grande (DRGW)	15028	Gray/Black	\$33.95
	50 006 789	Rio Grande (DRGW)	15096	Gray/Black	\$33.95
	50 006 790	Farmrail (GNBC)	1002	Teal/White	\$33.95
	50 006 791	Farmrail (GNBC)	1003	Brown/White	\$33.95
	50 006 792	Farmrail (GNBC)	1004	Blue/White	\$33.95
	50 006 793	Farmrail (GNBC)	1005	Gray/Black	\$33.95
	50 006 794	Pillsbury (TLDX)	5703	Gray/Blue	\$33.95
	50 006 795	Pillsbury (TLDX)	5704	Gray/Blue	\$33.95
	50 006 796	Pillsbury (TLDX)	5705	Gray/Blue	\$33.95
	50 006 797	Cargill (TLDX)	2831	Yellow/White/Black	\$33.95
	50 006 798	Cargill (TLDX)	5050	Yellow/White/Black	\$33.95
	50 006 799	Cargill (TLDX)	6143	Yellow/White/Black	\$33.95
	50 006 800	Louis Dreyfus (TLDX)	5944	Blue/Black	\$33.95
	50 006 801	Louis Dreyfus (TLDX)	5946	Blue/Black	\$33.95
	50 006 802	Louis Dreyfus (TLDX)	5975	Blue/Black	\$33.95
	50 006 803	Garvey (GELX)	16	Gray /Red	\$33.95
	50 006 804	Garvey (GELX)	17	Gray /Red	\$33.95
	50 006 805	Garvey (GELX)	18	Gray /Red	\$33.95
TOTAL PIECES ORDERED					

Introduced by Pullman in the mid-1960s, the PS-4427 low side covered hopper became the backbone car for many of the large grain hauling railroads as well as the car of choice for many leasing companies. The 4427 also was used to haul malt and sand products, which increased their venerability. Many of these hoppers wore colorful, diverse schemes, which featured large logos or lettering. Some of these cars still exist in service today.

Features:

- Sturdy body
- Detailed brake wheel and air reservoir
- Crisp lettering
- Accurate paint schemes
- Knuckle couplers



Farmrail (GNBC) (Brown)



Farmrail (GNBC) (Blue)



Farmrail (GNBC) (Gray)

Atlas Model Railroad Co., Inc. • 378 Florence Ave., Hillside, NJ 07205 • USA • ph: 908-687-0880 • fax: 908-687-8857 • shop.atlasrr.com



PRE-ORDER ANNOUNCEMENTS - JANUARY 2024

GUARANTEED PRE-ORDER DUE DATE: WEDNESDAY MARCH 13TH 2024



ATLAS MASTER® N 40' STANDARD HEIGHT CONTAINERS

Product Info: <https://shop.atlasrr.com/d-715-100th-anniversary-catalog-1-n.aspx>

NEW PAINT SCHEMES

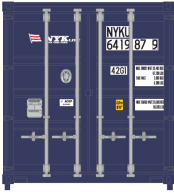

NYK Line (NYKU)

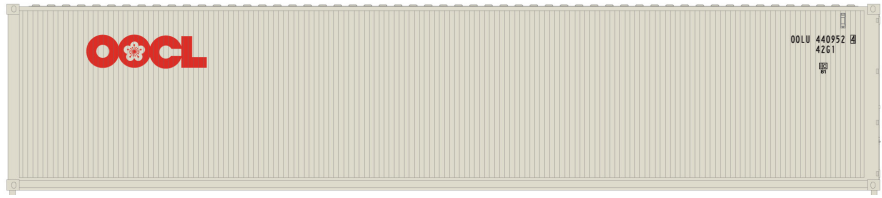

Orient Overseas Container Line (OOLU)

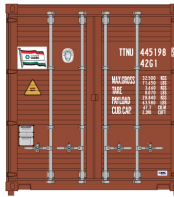

Triton/United Arab Shipping Co. (TTNU)

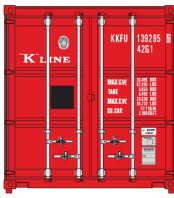

K-Line.com (KKFU)



PRE-ORDER ANNOUNCEMENTS - JANUARY 2024

GUARANTEED PRE-ORDER DUE DATE: WEDNESDAY MARCH 13TH 2024



ATLAS MASTER® N 40' STANDARD HEIGHT CONTAINERS

ESTIMATED ARRIVAL: 3rd Quarter 2024 Arrival

ORDER IN PIECES	ITEM	ROAD NAME	ROAD #	COLOR	MSRP / UNIT
NEW PAINT SCHEMES					
	50 006 824	NYK Line (NYKU)	3-pack Set #1	Blue	\$42.95
	50 006 825	NYK Line (NYKU)	3-pack Set #2	Blue	\$42.95
	50 006 826	Orient Overseas Container Line (OOLU)	3-pack Set #1	Beige	\$42.95
	50 006 827	Orient Overseas Container Line (OOLU)	3-pack Set #2	Beige	\$42.95
	50 006 828	Triton / United Arab Shipping Co. (TTNU)	3-pack Set #1	Brown	\$42.95
	50 006 829	Triton / United Arab Shipping Co. (TTNU)	3-pack Set #2	Brown	\$42.95
	50 006 830	K-Line.com (KKFU)	3-pack Set #1	Red	\$42.95
	50 006 831	K-Line.com (KKFU)	3-pack Set #2	Red	\$42.95
NEW ROAD NUMBERS					
	50 006 832	Ocean Network Express (TLLU)	3-pack Set #1	Pink	\$42.95
	50 006 833	Ocean Network Express (TLLU)	3-pack Set #2	Pink	\$42.95
TOTAL PIECES ORDERED					

The development of shipping containers reached a turning point in the late 1970s when standardization began to take place. Prior to this time numerous designs and sizes of containers were seen throughout the world. The true intermodal era began in the 1980s with the expanding world economy, Panama Canal ship size restrictions, intermodal railway car (wagon) designs and the setting of ISO standards for international shipping containers.

Today's commonly seen steel all-corrugated ISO containers still have some variations, primarily the doors. The new Atlas model will be a standard-height 40-footer which will exhibit a range of door styles, roofs, and front walls to more closely match the variations in the prototype containers seen throughout the world.

Features:

- Prototypically accurate "beveled" all corrugated sides
- Each set comes as a 3-pack

Each set comes as a 3-pack!

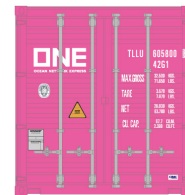

Ocean Network Express (TLLU)



PRE-ORDER ANNOUNCEMENTS - JANUARY 2024

GUARANTEED PRE-ORDER DUE DATE: WEDNESDAY MARCH 13TH 2024

N
SCALE

ATLAS TRAINMAN® N 42' GONDOLA

**ALL NEW
PAINT
SCHEMES**

Product Info: <https://shop.atlasrr.com/d-715-100th-anniversary-catalog-1-n.aspx>

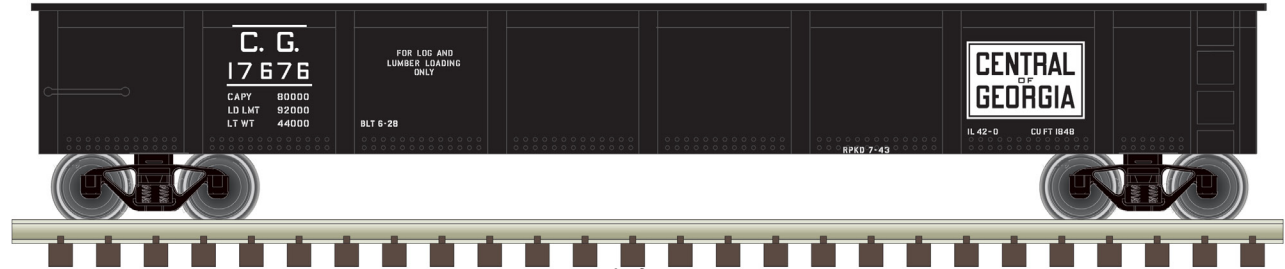

Central of Georgia

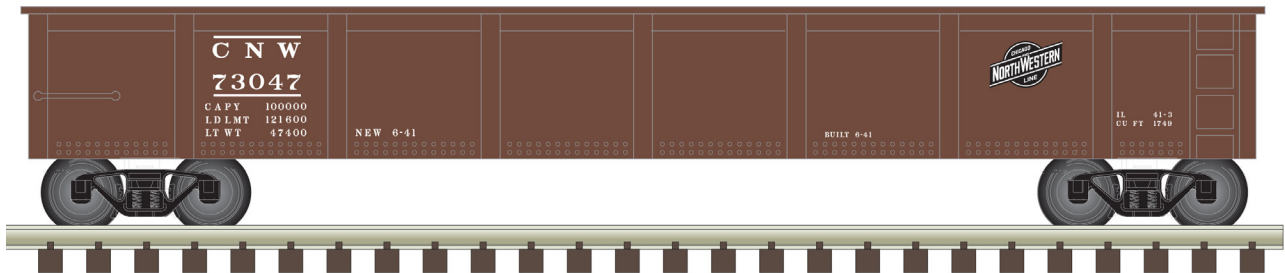

Chicago & North Western

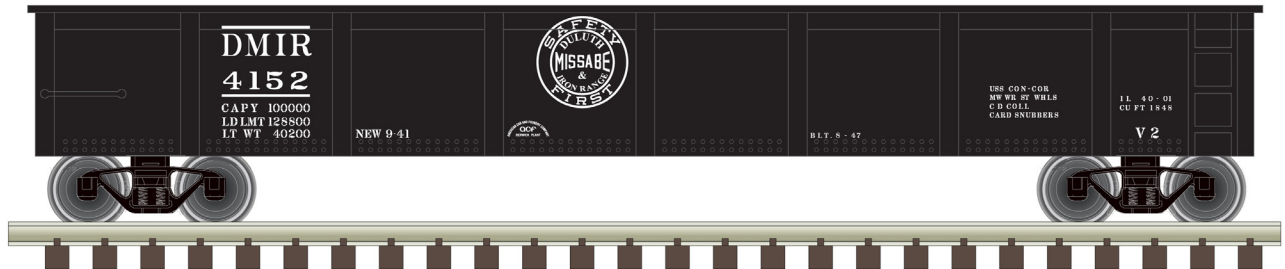

Duluth Missable & Iron Range

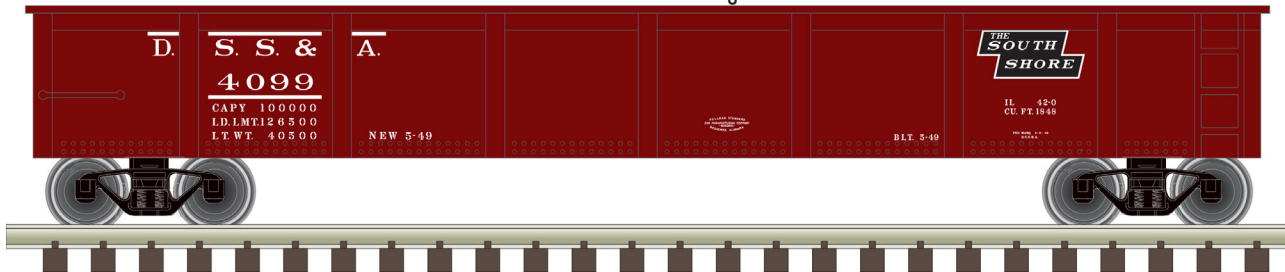

Duluth South Shore & Atlantic

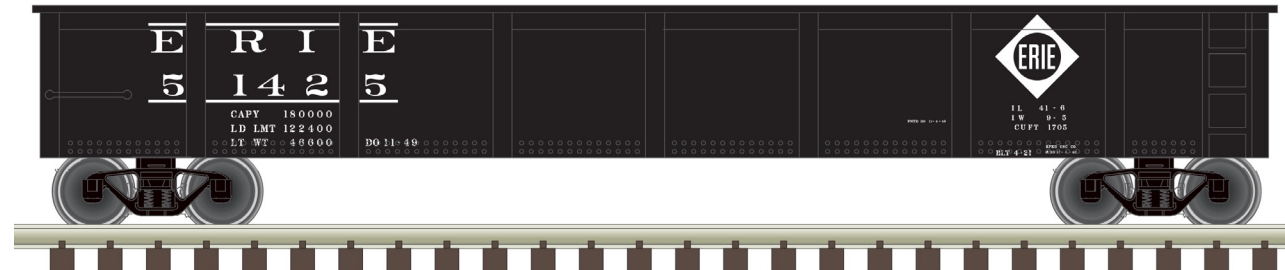

Erie

*CSX Licensed Product

Atlas Model Railroad Co., Inc. • 378 Florence Ave., Hillside, NJ 07205 • USA • ph: 908-687-0880 • fax: 908-687-8857 • shop.atlasrr.com



PRE-ORDER ANNOUNCEMENTS - JANUARY 2024

GUARANTEED PRE-ORDER DUE DATE: WEDNESDAY MARCH 13TH 2024



ATLAS TRAINMAN® N 42' GONDOLA

ESTIMATED ARRIVAL: 3rd Quarter 2024 Arrival

ORDER IN PIECES	ITEM	ROAD NAME	ROAD #	COLOR	MSRP / UNIT
ALL NEW PAINT SCHEMES					
	50 006 746	Central of Georgia (C. G.)	17553	Black/White	\$22.95
	50 006 747	Central of Georgia (C. G.)	17676	Black/White	\$22.95
	50 006 748	Chicago & North Western (C N W)	73047	Red/White	\$22.95
	50 006 749	Chicago & North Western (C N W)	73101	Red/White	\$22.95
	50 006 750	Duluth Missabe & Iron Range (DM&IR)	4152	Black/White	\$22.95
	50 006 751	Duluth Missabe & Iron Range (DM&IR)	4166	Black/White	\$22.95
	50 006 752	Duluth South Shore & Atlantic (DSS&A)	4004	Boxcar Red/White	\$22.95
	50 006 753	Duluth South Shore & Atlantic (DSS&A)	4099	Boxcar Red/White	\$22.95
	50 006 754	Erie	51425	Black/White	\$22.95
	50 006 755	Erie	51631	Black/White	\$22.95
	50 006 756	Missouri Kansas Texas (MKT)	43393	Boxcar Red/White	\$22.95
	50 006 757	Missouri Kansas Texas (MKT)	43385	Boxcar Red/White	\$22.95
	50 006 758	Nashville Chattanooga & St.Louis (NC&StL)*	44275	Boxcar Red/White	\$22.95
	50 006 759	Nashville Chattanooga & St.Louis (NC&StL)*	44499	Boxcar Red/White	\$22.95
TOTAL PIECES ORDERED					

Present on the rails from the steam era and transitioning for use through the early diesel era, gondolas carried many different types of loads, from wood chips to scrap metal to containers for goods such as cement. Atlas' model features removable cement loads and will fit layouts from the 1940s through the 1960s.

Features:

- Colorful painting and printing
- Detailed underframe
- Removable cement container load
- Ready-to-run
- Rivet detail
- AccuMate® couplers

AccuMate® couplers are made under license from AccuRail, Inc.



Previous run model shown with removable cement container load also included on this run.

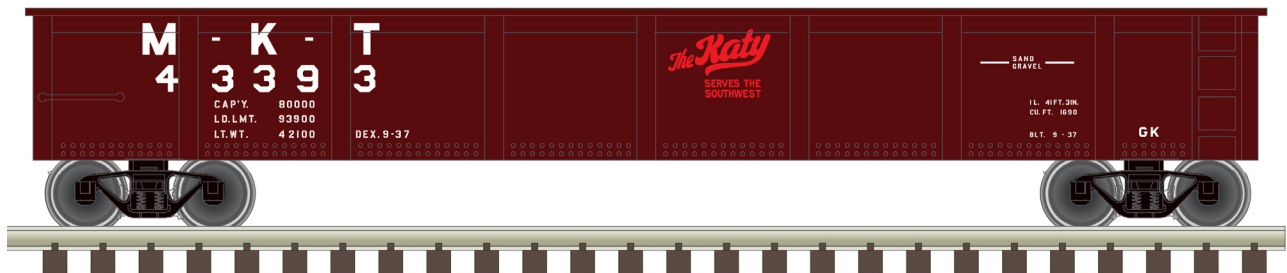

Missouri Kansas Texas

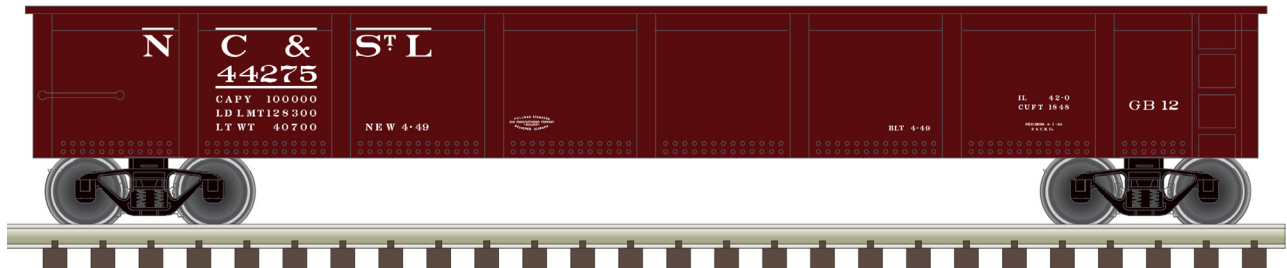

*CSX Licensed Product

Nashville Chattanooga & St. Louis*
 Atlas Model Railroad Co., Inc. • 378 Florence Ave., Hillside, NJ 07205 • USA • ph: 908-687-0880 • fax: 908-687-8857 • shop.atlasrr.com

Need A New Layout for

Atlas has you covered with a wide variety of track plans
The plans contain all of the needed track and

Books & Instructional Guides

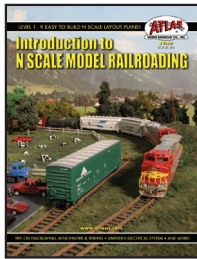

Item #6: Introduction to N Scale Model Railroading

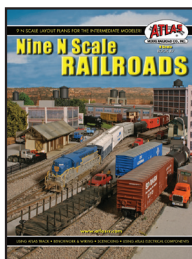

Item #7: Nine N Scale Railroads

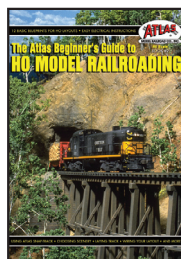

Item #9: Beginners Guide to HO Model Railroading



Item #11: Atlas HO Layouts For Every Space



Item #12: The Complete Atlas Wiring Book

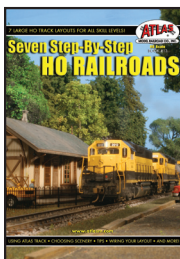

Item #13: Seven Step-by-Step HO Railroads

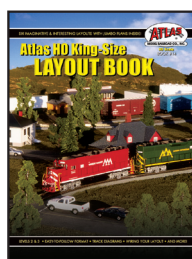

Item #14: HO King Size Layout Book

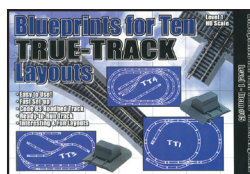

Item #15: Blueprints for Ten HO True-Track Layouts

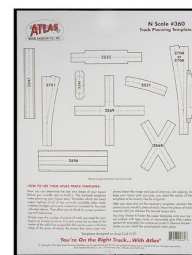

Item #360/361: N or HO Track Planning Templates

The myriad selection of Atlas layout track plans can be found online at shop.atlasrr.com, or in any of the layout books shown above.

Atlas Track Planning Software

Atlas is proud to offer Atlas Track Planning Software to help you design your dream layout. This software allows you to create & customize a layout, view it as a 3D model and then generate a shopping list to make your dream layout a reality.

Note - this software works on Windows OS only.

Features:

- Choose from a wide variety of Atlas track lines and create your dream layout.
- Model flex-track routes in an easy, intuitive and realistic way
- Arrange your layout on multiple levels with different heights and grades
- Easily draw figures to create train stations, houses, industries, roads & infrastructure
- Use the 3D tool to bring your layout to life
- Measure distances and track section lengths
- Export, Print or Share your layout with your friends
- View and print a list of the Atlas track pieces you need to begin building your layout
- Layout libraries will be available with future library updates

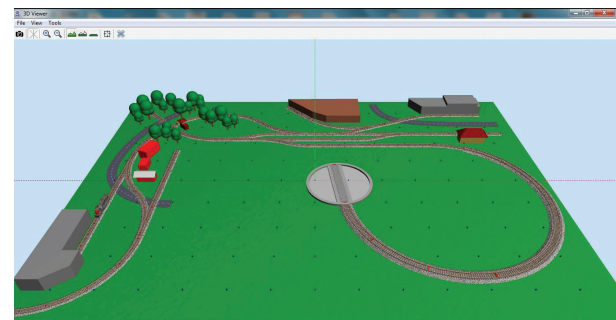

Atlas Track Planning Software 3-D viewer

Your Model Train Empire?

ried and true layout track plans in N & HO scale.
accessories to build the layout of your choice.

No Matter the Scale, No Matter the Space - Atlas Has the Layout For You!

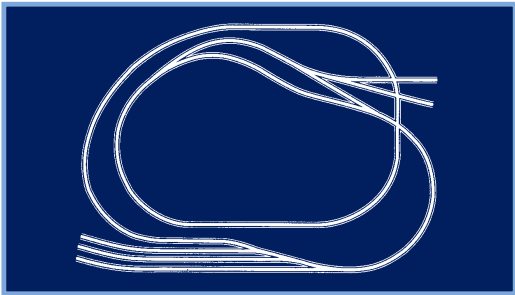

N CODE 80: N-7 TWICE AROUND VIA "UP & OVER"

From Book #6: *Introduction to N Scale Model Railroading*

Minimum Table Size Required: 32" x 45"

Products Required: Straight sections, radius sections, turnouts, a crossing, bumpers, insulated joiners and terminal joiners, necessary electrical components

If you enjoy watching a long train work its way up and down the grades of a long winding main line, the N7 is the layout for you. On this layout, yard tracks are available for breaking up and storing long trains, and a passing track with two industry spurs is available to provide additional operating diversions.

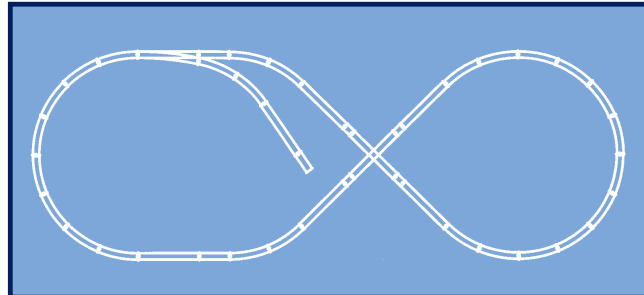

N SCALE CODE 55: N-504 PLATTSBURG PRETZEL

From web site: shop.atlasrr.com **Minimum Table Size Required:** 2' x 5'

Products Required: Straight & radius sections, turnouts, a crossing, terminal joiners, bumper and a selector

Take an ordinary oval track, twist one end and you have one of the most popular track plan elements: the Figure 8. The Plattsburg Pretzel is a Figure 8, keeping operation interesting by making the train appear to reverse its direction as it proceeds. This layout also adds interest by adding a spur for more train enjoyment.

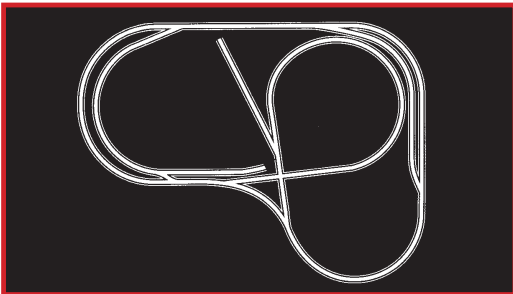

HO CODE 83/100: HO-7 THE JUNIOR PRETZEL

From Book #9: *Beginner's Guide to HO Model Railroading*

Minimum Table Size Required: 6' x 8'

Products Required: Straight sections, radius sections, Snap-Switches, rerailers, terminal sections, a crossing, bumpers, rail joiners and the necessary electrical components

Since it is built on an extended platform, there are many possibilities with the HO-7; such as longer runs, longer trains and more realistic operations.

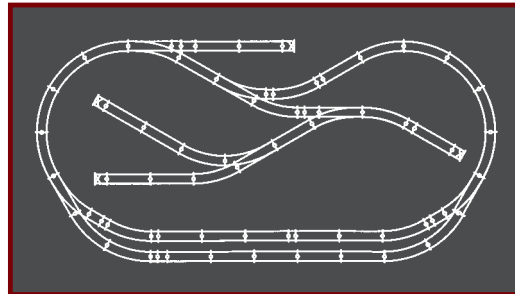

TT-3 MARTIN'S CREEK & SOUTHERN

From Book #15: *Blueprints for 10 True-Track® Layouts*

Minimum Table Size Required: 4' x 8'

Products Required: Straight sections, radius sections, Snap-Switches, bumpers, insulated joiners and terminal joiners, a Selector, necessary electrical components

The Martin's Creek & Southern adds a passing siding and a dogleg to the basic oval, increasing interest and slightly lengthening the main line run. The spurs on the inside of the oval, along with the one in the dogleg, add switching locations.

***Find all of Atlas' N & HO Scale Layout Packages,
Books, Software & MORE at shop.atlasrr.com!***



PRE-ORDER ANNOUNCEMENTS - JANUARY 2024

GUARANTEED PRE-ORDER DUE DATE: WEDNESDAY MARCH 13TH 2024

HO
SCALE

ATLAS MASTER® HO SD-35 LOCOMOTIVE

Product Info: <https://shop.atlasrr.com/d-714-100th-anniversary-catalog-1-ho.aspx>

SILVER MODELS:
SOUND READY***

GOLD MODELS:
SOUND-EQUIPPED**

NEW
PAINT
SCHEMES



Cargill



CSX*



Montana Rail Link

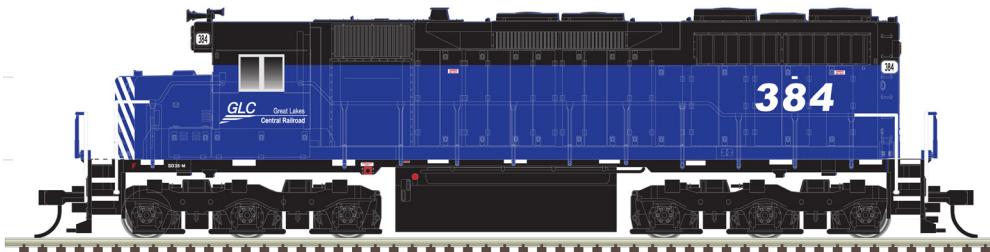

Great Lakes Central

*CSX Licensed Product

Atlas Model Railroad Co., Inc. • 378 Florence Ave., Hillside, NJ 07205 • USA • ph: 908-687-0880 • fax: 908-687-8857 • shop.atlasrr.com



PRE-ORDER ANNOUNCEMENTS - JANUARY 2024

GUARANTEED PRE-ORDER DUE DATE: WEDNESDAY MARCH 13TH 2024

HO
SCALE

ATLAS MASTER® HO SD-35 LOCOMOTIVE

Back By Popular Demand



Guilford



Baltimore & Ohio*

Southern Pacific models will feature new tooling for the nose light detail.

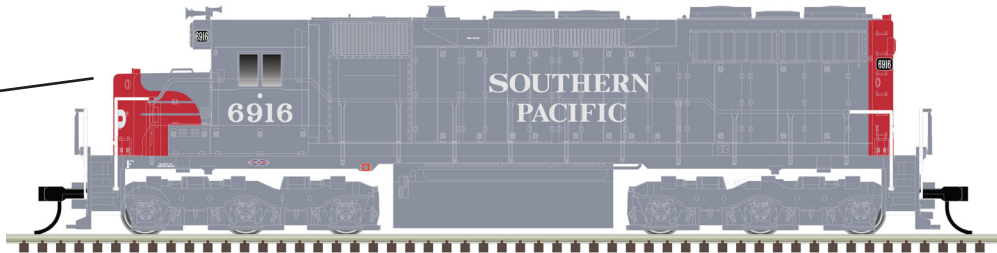

Southern Pacific

*****Silver Sound Ready™**
Atlas Silver Sound Ready models are equipped with a speaker for easy conversion to sound with the addition of a decoder. If you need assistance with the upgrade of a Sound Ready model, please contact Atlas Customer Service at 908-687-0880 or csdept@atlasrr.com



Southern



Silver Sound Ready™

Wired speaker and enclosure included for easy conversion to sound.

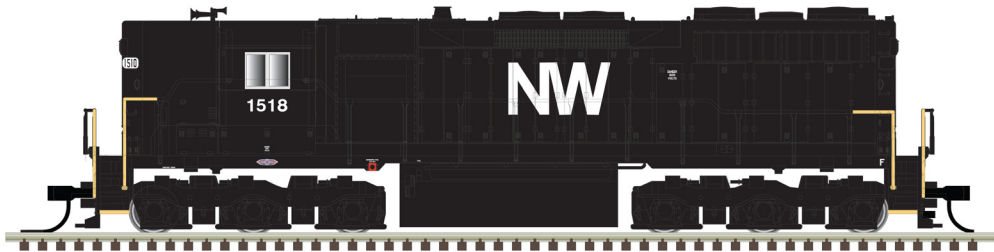

Norfolk & Western



****Gold Models with ESU Sound**



PRE-ORDER ANNOUNCEMENTS - JANUARY 2024

GUARANTEED PRE-ORDER DUE DATE: WEDNESDAY MARCH 13TH 2024



ATLAS MASTER® HO SD-35 LOCOMOTIVE

**SILVER MODELS:
SOUND READY*****

Product Info: <https://shop.atlasrr.com/d-714-100th-anniversary-catalog-1-ho.aspx>

ESTIMATED ARRIVAL: 4th Quarter 2024 Arrival

ORDER IN PIECES	SILVER ITEM	ROAD NAME	ROAD #	COLOR	MSRP/UNIT
SD-35 LOW NOSE LOCOMOTIVE					
NEW PAINT SCHEME					
	10 004 449	Cargill	606	Green/White	\$189.95
NEW ROAD NUMBERS					
	10 004 450	Baltimore & Ohio*	7402	Blue/Yellow	\$189.95
	10 004 451	Baltimore & Ohio*	7419	Blue/Yellow	\$189.95
NEW PAINT SCHEME					
	10 004 452	CSX*	4519	Gray/Blue	\$189.95
	10 004 453	CSX*	4525	Gray/Blue	\$189.95
BACK BY POPULAR DEMAND					
	10 004 454	Guilford	614	Gray/Orange/White	\$189.95
NEW PAINT SCHEMES					
	10 004 455	Montana Rail Link	701	Blue/Black	\$189.95
	10 004 456	Montana Rail Link	702	Blue/Black	\$189.95
	10 004 457	Great Lakes Central	384	Blue/Black	\$189.95
	10 004 458	Great Lakes Central	386	Blue/Black	\$189.95
NEW ROAD NUMBERS					
	10 004 459	Southern Pacific	6909	Gray/Red	\$189.95
	10 004 460	Southern Pacific	6916	Gray/Red	\$189.95
SD-35 HIGH NOSE LOCOMOTIVE					
NEW ROAD NUMBERS					
	10 004 461	Southern	3006	Black/White	\$189.95
	10 004 462	Southern	3030	Black/White	\$189.95
	10 004 463	Norfolk & Western	1504	Black/White	\$189.95
	10 004 464	Norfolk & Western	1518	Black/White	\$189.95
TOTAL PIECES ORDERED					

Between 1964 and 1966, EMD built a total of 360 six-axle 2,500hp SD35 locomotives. From the mid-1960s through the 1980s, the SD-35 could be found in road service on both large and mid-sized roads across the US. Today the number of active units has dwindled to a select few, including those operated by regional railroad Montana Rail Link. Atlas' model incorporates many of the subtle details that differentiated the various SD-35 production phases. This includes the detail of the engine air intake, dust bin, radiator screens, radiator fans, fuel tanks and battery boxes.

Features:

- Realistic die-cast underframe
- Five-pole skewed armature motor with dual flywheels for optimum performance at all speeds
- Golden-white LEDs
- Directional lighting
- Factory-equipped with AccuMate® knuckle couplers (AccuMate® couplers are made under license from AccuRail, Inc.)
- Detailed cab interior with crew
- Separately-installed scale windshield wipers, metal grab irons and fine scale handrails
- Marker lights with separate lenses
- Scale fans and grille detail
- Flat dust bin or raised dust bin as appropriate by railroad
- Snowplow (included but not installed)
- Atlas Master™ Series Silver Additional Features:
- NMRA 21-pin plug for DCC (Decoder-ready)

Atlas Model Railroad Co., Inc. • 378 Florence Ave., Hillside, NJ 07205 • USA • ph: 908-687-0880 • fax: 908-687-8857 • shop.atlasrr.com



**Silver
Sound Ready™**

Wired speaker and enclosure included for easy conversion to sound.

***Silver Sound Ready™

Atlas Silver Sound Ready models are equipped with a speaker for easy conversion to sound with the addition of a decoder. If you need assistance with the upgrade of a Sound Ready model, please contact Atlas Customer Service at 908-687-0880 or csdept@atlasrr.com

**CSX Licensed Product*



PRE-ORDER ANNOUNCEMENTS - JANUARY 2024

GUARANTEED PRE-ORDER DUE DATE: WEDNESDAY MARCH 13TH 2024



ATLAS MASTER® HO SD-35 LOCOMOTIVE

**GOLD MODELS:
SOUND-EQUIPPED****

Product Info: <https://shop.atlasrr.com/d-714-100th-anniversary-catalog-1-ho.aspx>

ESTIMATED ARRIVAL: 4th Quarter 2024 Arrival

ORDER IN PIECES	GOLD ITEM	ROAD NAME	ROAD #	COLOR	MSRP/ UNIT
SD-35 LOW NOSE LOCOMOTIVE					
NEW PAINT SCHEME					
	10 004 465	Cargill	606	Green/White	\$294.95
NEW ROAD NUMBERS					
	10 004 466	Baltimore & Ohio*	7402	Blue/Yellow	\$294.95
	10 004 467	Baltimore & Ohio*	7419	Blue/Yellow	\$294.95
NEW PAINT SCHEME					
	10 004 468	CSX*	4519	Gray/Blue	\$294.95
	10 004 469	CSX*	4525	Gray/Blue	\$294.95
BACK BY POPULAR DEMAND					
	10 004 470	Guilford	614	Gray/Orange/White	\$294.95
NEW PAINT SCHEMES					
	10 004 471	Montana Rail Link	701	Blue/Black	\$294.95
	10 004 472	Montana Rail Link	702	Blue/Black	\$294.95
	10 004 473	Great Lakes Central	384	Blue/Black	\$294.95
	10 004 474	Great Lakes Central	386	Blue/Black	\$294.95
NEW ROAD NUMBERS					
	10 004 475	Southern Pacific	6909	Gray/Red	\$294.95
	10 004 476	Southern Pacific	6916	Gray/Red	\$294.95
SD-35 HIGH NOSE LOCOMOTIVE					
NEW ROAD NUMBERS					
	10 004 477	Southern	3006	Black/White	\$294.95
	10 004 478	Southern	3030	Black/White	\$294.95
	10 004 479	Norfolk & Western	1504	Black/White	\$294.95
	10 004 480	Norfolk & Western	1518	Black/White	\$294.95
TOTAL PIECES ORDERED					

DCC Operation Features:

- Supports all DCC-programming modes • Flexible mapping of function keys F0 to F28. • A total of six DCC function outputs are available
- Follows all NMRA DCC standards and recommended practices.

Analog (DC) Operation Features:

- The LokSound Select Dual-Mode decoder allows your Atlas Gold Series locomotive to be used on DC as well as on DCC layouts. Please note that the Atlas Quantum Engineer will NOT operate an Atlas Gold Series locomotive equipped with a LokSound Select decoder on an analog (DC) layout. However, the sound and lighting functions of the LokSound Select decoder in the locomotive can be controlled by an easy-to-use basic DCC system
- Also note that on a DC-powered layout, a DCC and sound equipped locomotive CANNOT be consisted with another locomotive that does not also have both DCC and sound. (This statement does NOT apply to DCC-equipped locomotives operating on a DCC layout.)

ESU Sound Functionality Features:

- Over 20 sound effects are available, including engine start-up and shutdown, prime mover sounds through all eight notches, bell, air horn, air compressor, dynamic brakes and more. There are 16 user-selectable horns, 2 user-selectable bells, and 2 user-selectable synchronized brake squeals.
- Manual and Automatic Notching modes with the ability to change modes "on the fly" are provided for true realism.

*CSX Licensed Product



**Gold Models
with ESU Sound



PRE-ORDER ANNOUNCEMENTS - JANUARY 2024

GUARANTEED PRE-ORDER DUE DATE: WEDNESDAY MARCH 13TH 2024



ATLAS CLASSIC[®] HO RS-11 LOCOMOTIVE

Product Info: <https://shop.atlasrr.com/d-714-100th-anniversary-catalog-1-ho.aspx>

**NEW
PAINT
SCHEMES**

**SILVER MODELS:
SOUND READY*****

**GOLD MODELS:
SOUND-EQUIPPED****

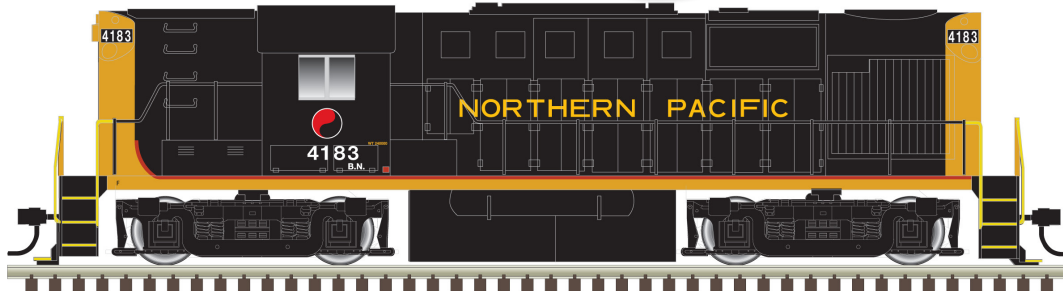

Burlington Northern (Northern Pacific patch)



Duluth, Winnipeg & Pacific (DWP) Bicentennial

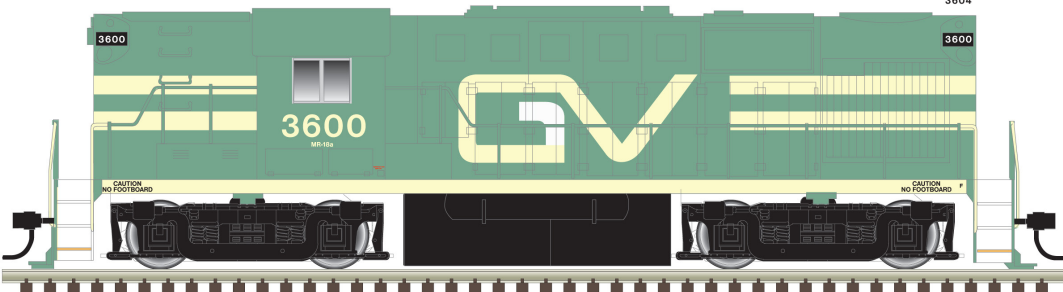

Genesee Valley



Ferrocarril del Pacifico

*CSX Licensed Product

Atlas Model Railroad Co., Inc. • 378 Florence Ave., Hillside, NJ 07205 • USA • ph: 908-687-0880 • fax: 908-687-8857 • shop.atlasrr.com

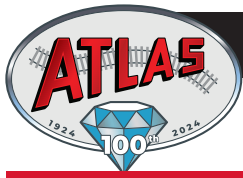

PRE-ORDER ANNOUNCEMENTS - JANUARY 2024

GUARANTEED PRE-ORDER DUE DATE: WEDNESDAY MARCH 13TH 2024



ATLAS CLASSIC® HO RS-11 LOCOMOTIVE

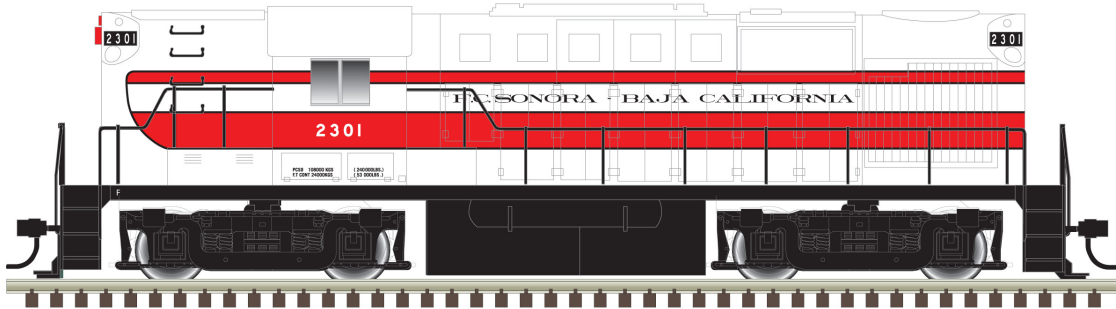

Sonora Baja California



Norfolk & Western

**NEW
ROAD
NUMBERS**

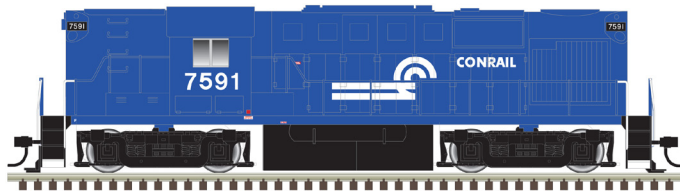

Conrail



Lehigh Valley



Louisville & Nashville*

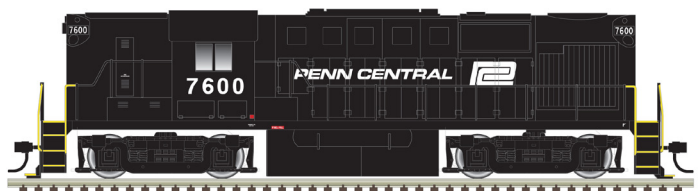

Penn Central



**Silver
Sound Ready™**

Wired speaker and enclosure included for easy conversion to sound.

***Silver Sound Ready™

Atlas Silver Sound Ready models are equipped with a speaker for easy conversion to sound with the addition of a decoder. If you need assistance with the upgrade of a Sound Ready model, please contact Atlas Customer Service at 908-687-0880 or csdept@atlasrr.com

*CSX Licensed Product



**Gold Models
with ESU Sound

Atlas Model Railroad Co., Inc. • 378 Florence Ave., Hillside, NJ 07205 • USA • ph: 908-687-0880 • fax: 908-687-8857 • shop.atlasrr.com



PRE-ORDER ANNOUNCEMENTS - JANUARY 2024

GUARANTEED PRE-ORDER DUE DATE: WEDNESDAY MARCH 13TH 2024



ATLAS CLASSIC® HO RS-11 LOCOMOTIVE

**SILVER MODELS:
SOUND READY*****

Product Info: <https://shop.atlasrr.com/d-714-100th-anniversary-catalog-1-ho.aspx>

ESTIMATED ARRIVAL: 4th Quarter 2024 Arrival

ORDER IN PIECES	SILVER ITEM	ROAD NAME	ROAD #	COLOR	MSRP / UNIT
NEW PAINT SCHEMES					
	10 004 517	Burlington Northern (Northern Pacific patch)	4180	Black/Orange/Red	\$174.95
	10 004 518	Burlington Northern (Northern Pacific patch)	4183	Black/Orange/Red	\$174.95
NEW ROAD NUMBERS					
	10 004 519	Conrail	7591	Blue/White	\$174.95
	10 004 520	Conrail	7598	Blue/White	\$174.95
NEW PAINT SCHEMES					
	10 004 521	Duluth, Winnipeg & Pacific (DWP) Bicentennial	3605	Red/White/Blue	\$174.95
	10 004 522	Genessee Valley	3600	Green/Yellow	\$174.95
	10 004 523	Genessee Valley	3604	Green/Yellow	\$174.95
	10 004 524	Ferrocarril del Pacifico	501	Yellow/Blue	\$174.95
	10 004 525	Sonora Baja California	2301	Red/White	\$174.95
	10 004 526	Norfolk and Western	322	Black/White	\$174.95
	10 004 527	Norfolk and Western	327	Black/White	\$174.95
NEW ROAD NUMBERS					
	10 004 528	Lehigh Valley	7640	Maroon/Gold	\$174.95
	10 004 529	Lehigh Valley	7643	Maroon/Gold	\$174.95
	10 004 530	Louisville & Nashville*	953	Gray/Yellow	\$174.95
	10 004 531	Louisville & Nashville*	958	Gray/Yellow	\$174.95
	10 004 532	Penn Central	7600	Black/White	\$174.95
	10 004 533	Penn Central	7604	Black/White	\$174.95
TOTAL PIECES ORDERED					

The first RS-11s were produced by Alco in early 1956. This locomotive, classified by Alco as model DL-701, was their replacement for the very popular RS-3 road-switcher. Featuring a V-12, 1,800hp 251B diesel engine, the RS-11 was Alco's answer to EMD's very successful GP9. The turbocharged RS-11 accelerated faster, had a higher tractive effort rating and typically used less fuel than the competition. It was also quite versatile and could be found in heavy haul freight as well as passenger service.

The largest owner of RS-11s was Norfolk & Western which purchased a total of 99 units (an additional 35 were added to the fleet after the merger with Nickel Plate). Other major purchasers included Northern Pacific, Pennsylvania and Southern Pacific, all of whom placed repeat orders. With approximately 426 units built for the US and Mexico over 8 years of production, the RS-11 was successful for Alco in that it provided ongoing competition for EMD's popular road-switchers. A few examples of this model are still in service today and can be found working for various shortlines in the US.

Features:

- Golden-white LEDs
- Realistic die-cast mainframe
- Five-pole skewed armature motor with dual flywheels for optimum performance at all speeds
- Directional lighting
- Factory-equipped with AccuMate® knuckle couplers
- Separately-applied wire grab irons
- MU hoses and coupler cut bars
- Two painted crew members

Atlas Master™ Series Silver Additional Features:

- NMRA 21-pin plug for DCC (Decoder-ready)

Atlas Model Railroad Co., Inc. • 378 Florence Ave., Hillside, NJ 07205 • USA • ph: 908-687-0880 • fax: 908-687-8857 • shop.atlasrr.com



**Silver
Sound Ready™**

Wired speaker and enclosure included for easy conversion to sound.

***Silver Sound Ready™

Atlas Silver Sound Ready models are equipped with a speaker for easy conversion to sound with the addition of a decoder. If you need assistance with the upgrade of a Sound Ready model, please contact Atlas Customer Service at 908-687-0880 or csdept@atlasrr.com

**CSX Licensed Product*



PRE-ORDER ANNOUNCEMENTS - JANUARY 2024

GUARANTEED PRE-ORDER DUE DATE: WEDNESDAY MARCH 13TH 2024



ATLAS CLASSIC® HO RS-11 LOCOMOTIVE

**GOLD MODELS:
SOUND-EQUIPPED****

Product Info: <https://shop.atlasrr.com/d-714-100th-anniversary-catalog-1-ho.aspx>

ESTIMATED ARRIVAL: 4th Quarter 2024 Arrival

ORDER IN PIECES	GOLD ITEM	ROAD NAME	ROAD #	COLOR	MSRP / UNIT
NEW PAINT SCHEMES					
	10 004 534	Burlington Northern (Northern Pacific patch)	4180	Black/Orange/Red	\$289.95
	10 004 535	Burlington Northern (Northern Pacific patch)	4183	Black/Orange/Red	\$289.95
NEW ROAD NUMBERS					
	10 004 536	Conrail	7591	Blue/White	\$289.95
	10 004 537	Conrail	7598	Blue/White	\$289.95
NEW PAINT SCHEMES					
	10 004 538	Duluth, Winnipeg & Pacific (DWP) Bicentennial	3605	Red/White/Blue	\$289.95
	10 004 539	Genessee Valley	3600	Green/Yellow	\$289.95
	10 004 540	Genessee Valley	3604	Green/Yellow	\$289.95
	10 004 541	Ferrocarril del Pacifico	501	Yellow/Blue	\$289.95
	10 004 542	Sonora Baja California	2301	Red/White	\$289.95
	10 004 543	Norfolk and Western	322	Black/White	\$289.95
	10 004 544	Norfolk and Western	327	Black/White	\$289.95
NEW ROAD NUMBERS					
	10 004 545	Lehigh Valley	7640	Maroon/Gold	\$289.95
	10 004 546	Lehigh Valley	7643	Maroon/Gold	\$289.95
	10 004 547	Louisville & Nashville*	953	Gray/Yellow	\$289.95
	10 004 548	Louisville & Nashville*	958	Gray/Yellow	\$289.95
	10 004 549	Penn Central	7600	Black/White	\$289.95
	10 004 550	Penn Central	7604	Black/White	\$289.95
TOTAL PIECES ORDERED					

DCC Operation Features:

- Supports all DCC-programming modes • Flexible mapping of function keys F0 to F28. • A total of six DCC function outputs are available
- Follows all NMRA DCC standards and recommended practices.

Analog (DC) Operation Features:

- The LokSound Select Dual-Mode decoder allows your Atlas Gold Series locomotive to be used on DC as well as on DCC layouts. Please note that the Atlas Quantum Engineer will NOT operate an Atlas Gold Series locomotive equipped with a LokSound Select decoder on an analog (DC) layout. However, the sound and lighting functions of the LokSound Select decoder in the locomotive can be controlled by an easy-to-use basic DCC system
- Also note that on a DC-powered layout, a DCC and sound equipped locomotive CANNOT be consisted with another locomotive that does not also have both DCC and sound. (This statement does NOT apply to DCC-equipped locomotives operating on a DCC layout.)

ESU Sound Functionality Features:

- Over 20 sound effects are available, including engine start-up and shutdown, prime mover sounds through all eight notches, bell, air horn, air compressor, dynamic brakes and more. There are 16 user-selectable horns, 2 user-selectable bells, and 2 user-selectable synchronized brake squeals.
- Manual and Automatic Notching modes with the ability to change modes "on the fly" are provided for true realism.

**CSX Licensed Product*



****Gold Models
with ESU Sound**



PRE-ORDER ANNOUNCEMENTS - JANUARY 2024

GUARANTEED PRE-ORDER DUE DATE: WEDNESDAY MARCH 13TH 2024



ATLAS MASTER® HO 42' COIL STEEL CAR

Product Info: <https://shop.atlasrr.com/d-714-100th-anniversary-catalog-1-ho.aspx>

**NEW
PAINT
SCHEMES**

**NEW
ROAD
NUMBERS**

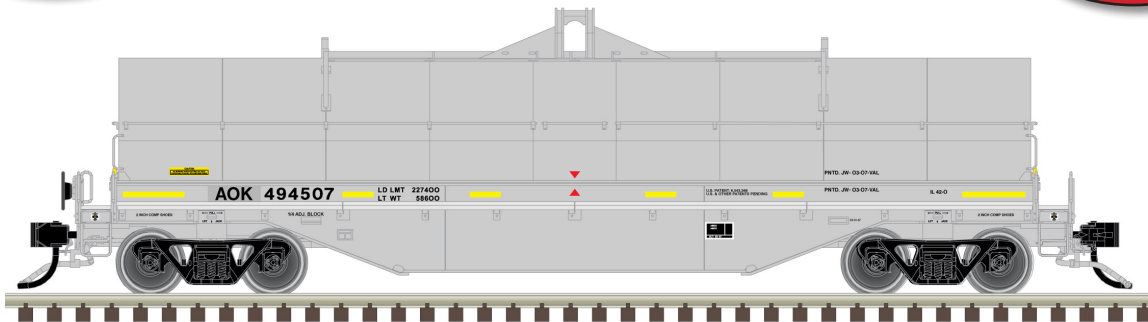

AOK (ex-CSXT)

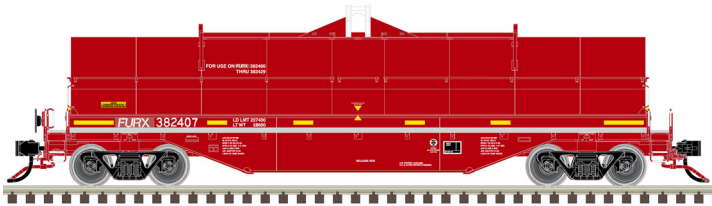

FURX (ex-NOKL)

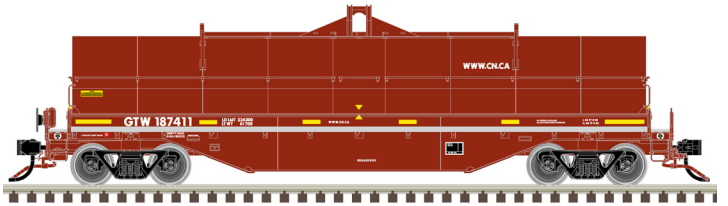

Grand Trunk Western (GTW) (CN web address)

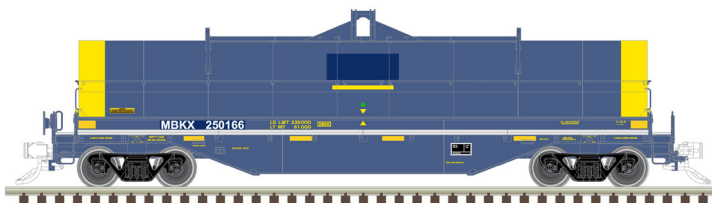

Mitsui Rail Capital (MBKX)

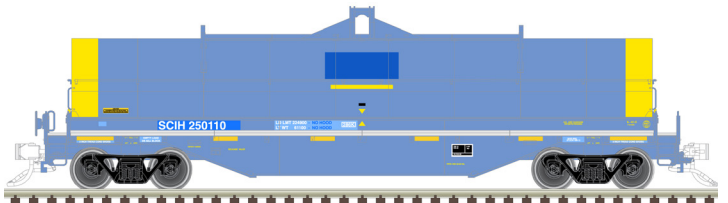

South Chicago & Indiana Harbor (SCIH)

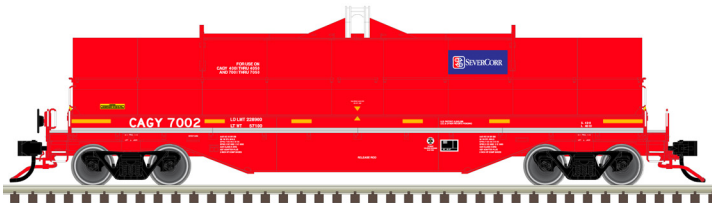

CAGY (ServerCorr)



Kansas City Southern (KCS)



PRE-ORDER ANNOUNCEMENTS - JANUARY 2024

GUARANTEED PRE-ORDER DUE DATE: WEDNESDAY MARCH 13TH 2024



ATLAS MASTER® HO 42' COIL STEEL CAR

ESTIMATED ARRIVAL: 3rd Quarter 2024 Arrival

ORDER IN PIECES	ITEM	ROAD NAME	ROAD #	COLOR	MSRP / UNIT
NEW PAINT SCHEMES					
	20 007 445	AOK (ex-CSXT)	494507	Gray/Black/Yellow	\$42.95
	20 007 446	AOK (ex-CSXT)	494502	Gray/Black/Yellow	\$42.95
	20 007 447	AOK (ex-CSXT)	494606	Gray/Black/Yellow	\$42.95
	20 007 448	AOK (ex-CSXT)	494621	Gray/Black/Yellow	\$42.95
	20 007 449	FURX (ex-NOKL)	382407	Red/White/Yellow	\$42.95
	20 007 450	FURX (ex-NOKL)	382411	Red/White/Yellow	\$42.95
	20 007 451	FURX (ex-NOKL)	382420	Red/White/Yellow	\$42.95
	20 007 452	FURX (ex-NOKL)	382426	Red/White/Yellow	\$42.95
	20 007 453	Grand Trunk Western (GTW) (CN web address)	187411	Brown/White/Yellow	\$42.95
	20 007 454	Grand Trunk Western (GTW) (CN web address)	187441	Brown/White/Yellow	\$42.95
	20 007 455	Grand Trunk Western (GTW) (CN web address)	187482	Brown/White/Yellow	\$42.95
	20 007 456	Grand Trunk Western (GTW) (CN web address)	187526	Brown/White/Yellow	\$42.95
	20 007 457	Mitsui Rail Capital (MBKX)	250114	Blue/Yellow	\$42.95
	20 007 458	Mitsui Rail Capital (MBKX)	250166	Blue/Yellow	\$42.95
	20 007 459	South Chicago & Indiana Harbor (SCIH)	250110	Blue/Yellow	\$42.95
	20 007 460	South Chicago & Indiana Harbor (SCIH)	250215	Blue/Yellow	\$42.95
NEW ROAD NUMBERS					
	20 007 461	CAGY (ServerCorr)	7002	Red/Blue/White	\$42.95
	20 007 462	CAGY (ServerCorr)	7008	Red/Blue/White	\$42.95
	20 007 463	CAGY (ServerCorr)	7010	Red/Blue/White	\$42.95
	20 007 464	CAGY (ServerCorr)	7032	Red/Blue/White	\$42.95
	20 007 465	Kansas City Southern (KCS)	720017	Gray/Black/Red/Yellow	\$42.95
	20 007 466	Kansas City Southern (KCS)	720023	Gray/Black/Red/Yellow	\$42.95
	20 007 467	Kansas City Southern (KCS)	720048	Gray/Black/Red/Yellow	\$42.95
	20 007 468	Kansas City Southern (KCS)	720133	Gray/Black/Red/Yellow	\$42.95
TOTAL PIECES ORDERED					

The increased volume of coiled steel transportation gave rise to a new purpose-built freight car. Previously rolls of coiled-steel had generally traveled in specially equipped gondola cars. In the 1960's a lighter type of car emerged specifically for hauling coils of steel in an integral trough. The car type gained popularity and eventually over 17,000 cars were built. Atlas' model replicates a 42' design with a distinctive fishbelly side sill.

Features:

- Crisp painting and lettering
- See-through walks
- Removable hood
- Inside floor detail
- Cut-levers



PRE-ORDER ANNOUNCEMENTS - JANUARY 2024

GUARANTEED PRE-ORDER DUE DATE: WEDNESDAY MARCH 13TH 2024



ATLAS MASTER[®] HO THRALL GONDOLA

Product Info: <https://shop.atlasrr.com/d-714-100th-anniversary-catalog-1-ho.aspx>

NEW
PAINT
SCHEMES

NEW
ROAD
NUMBERS



ICE (Iowa, Chicago & Eastern)

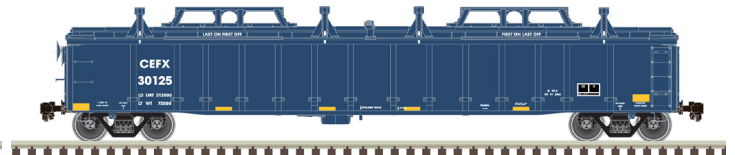

CEFX (CIT Group)



JTLX (CIT Group)

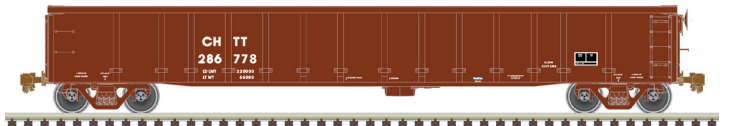

CHTT (Chicago Heights Terminal Transfer)



NS (Norfolk Southern) (ex CSXT)

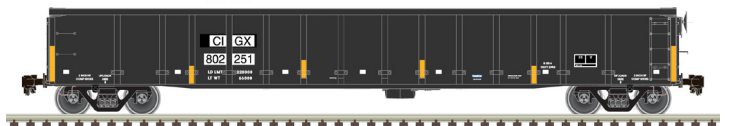

CIGX (CIT Group) (ex BNSF)

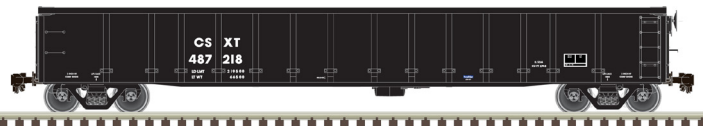

CSXT*

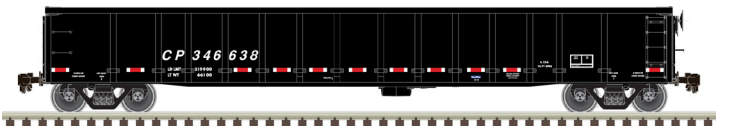

CP (Canadian Pacific)



PRE-ORDER ANNOUNCEMENTS - JANUARY 2024

GUARANTEED PRE-ORDER DUE DATE: WEDNESDAY MARCH 13TH 2024



ATLAS MASTER® HO THRALL GONDOLA

ESTIMATED ARRIVAL: 3rd Quarter 2024 Arrival

ORDER IN PIECES	ITEM	ROAD NAME	ROAD #	COLOR	MSRP / UNIT
NEW PAINT SCHEMES					
	20 007 405	ICE (Iowa Chicago & Eastern)	320024	Blue/Yellow	\$39.95
	20 007 406	ICE (Iowa Chicago & Eastern)	320061	Blue/Yellow	\$39.95
	20 007 407	ICE (Iowa Chicago & Eastern)	320063	Blue/Yellow	\$39.95
NEW ROAD NUMBERS					
	20 007 408	CEFX (CIT Group) (1st time offered with cover)	30125	Blue/White	\$44.95
	20 007 409	CEFX (CIT Group) (1st time offered with cover)	30126	Blue/White	\$44.95
	20 007 410	CEFX (CIT Group) (1st time offered with cover)	30276	Blue/White	\$44.95
	20 007 411	JTLX (CIT Group)	192	Black/White	\$39.95
	20 007 412	JTLX (CIT Group)	240	Black/White	\$39.95
	20 007 413	JTLX (CIT Group)	262	Black/White	\$39.95
NEW PAINT SCHEMES					
	20 007 414	CHTT (Chicago Heights Terminal Transfer)	286778	Brown	\$39.95
	20 007 415	CHTT (Chicago Heights Terminal Transfer)	286845	Brown	\$39.95
	20 007 416	CHTT (Chicago Heights Terminal Transfer)	286853	Brown	\$39.95
NEW ROAD NUMBERS					
	20 007 417	NS (Norfolk Southern) (ex CSXT)	201802	Black/White	\$39.95
	20 007 418	NS (Norfolk Southern) (ex CSXT)	201824	Black/White	\$39.95
	20 007 419	NS (Norfolk Southern) (ex CSXT)	201917	Black/White	\$39.95
NEW PAINT SCHEMES					
	20 007 420	CIGX (CIT Group) (ex BNSF)	802206	Black w/white patch	\$39.95
	20 007 421	CIGX (CIT Group) (ex BNSF)	802217	Black w/white patch	\$39.95
	20 007 422	CIGX (CIT Group) (ex BNSF)	802251	Black w/white patch	\$39.95
NEW ROAD NUMBERS					
	20 007 423	CSXT*	487218	Black/White	\$39.95
	20 007 424	CSXT*	487236	Black/White	\$39.95
	20 007 425	CSXT*	487398	Black/White	\$39.95
	20 007 426	CP (Canadian Pacific)	346638	Black/Red/White	\$39.95
	20 007 427	CP (Canadian Pacific)	346682	Black/Red/White	\$39.95
	20 007 428	CP (Canadian Pacific)	346784	Black/Red/White	\$39.95
TOTAL PIECES ORDERED					

The Thrall Car 2743 cubic foot gondola was introduced in 1995. This new 52' 6" interior length design was in response to the newly allowed increase in Gross Rail Loading (GRL) to 286,000 lbs (up from 263,000 lbs). This allowed an increase of the inside height from the previously standard 5'0" to a new standard of 5'6", giving it a 2,743 cubic foot capacity. Thrall produced over 6,700 of these from 1995 to 1999. The design resumed production under TrinityRail® in 2005.

Features:

- Prototypical scale height reflecting the new higher capacities standard.
- Fourteen side posts
- Detailed brake components
- Etched platform
- Etched end reinforcement plate
- Detailed ladders and stirrups
- Metal hand grabs
- Metal brake rods
- Air hoses
- Corner pins and correct open notch
- Detailed side post support angle plates
- Opt. coupler pocket for Kadee #78 or Accumate Scale Coupler
- Accurate painting and lettering
- Ready-to-run

AccuMate® couplers are made under license from AccuRail, Inc.



PRE-ORDER ANNOUNCEMENTS - JANUARY 2024

GUARANTEED PRE-ORDER DUE DATE: WEDNESDAY MARCH 13TH 2024



ATLAS MASTER® HO 40' STANDARD HEIGHT CONTAINERS

Product Info: <https://shop.atlasrr.com/d-714-100th-anniversary-catalog-1-ho.aspx>

**NEW
PAINT
SCHEMES**

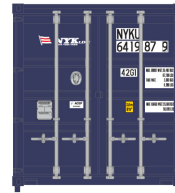

NYK Line (NYKU)

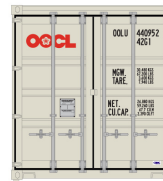
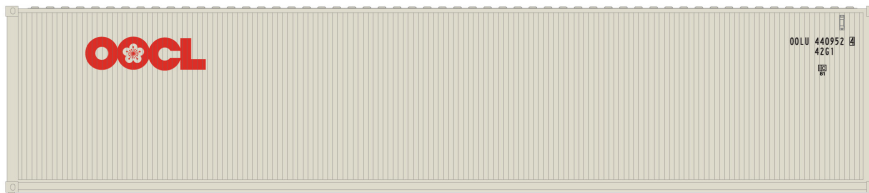

Orient Overseas
Container Line (OOLU)



Triton/United Arab
Shipping Co. (TTNU)



K-Line.com (KKFU)



PRE-ORDER ANNOUNCEMENTS - JANUARY 2024

GUARANTEED PRE-ORDER DUE DATE: WEDNESDAY MARCH 13TH 2024



ATLAS MASTER® HO 40' STANDARD HEIGHT CONTAINERS

ESTIMATED ARRIVAL: 3rd Quarter 2024 Arrival

ORDER IN PIECES	ITEM	ROAD NAME	ROAD #	COLOR	MSRP / UNIT
NEW PAINT SCHEMES					
	20 007 469	NYK Line (NYKU)	3-pack Set #1	Blue	\$49.95
	20 007 470	NYK Line (NYKU)	3-pack Set #2	Blue	\$49.95
	20 007 471	Orient Overseas Container Line (OOLLU)	3-pack Set #1	Beige	\$49.95
	20 007 472	Orient Overseas Container Line (OOLLU)	3-pack Set #2	Beige	\$49.95
	20 007 473	Triton / United Arab Shipping Co. (TTNU)	3-pack Set #1	Brown	\$49.95
	20 007 474	Triton / United Arab Shipping Co. (TTNU)	3-pack Set #2	Brown	\$49.95
	20 007 475	K-Line.com (KKFU)	3-pack Set #1	Red	\$49.95
	20 007 476	K-Line.com (KKFU)	3-pack Set #2	Red	\$49.95
NEW ROAD NUMBERS					
	20 007 477	Ocean Network Express (TLLU)	3-pack Set #1	Pink	\$49.95
	20 007 478	Ocean Network Express (TLLU)	3-pack Set #2	Pink	\$49.95
TOTAL PIECES ORDERED					

The development of shipping containers reached a turning point in the late 1970s when standardization began to take place. Prior to this time numerous designs and sizes of containers were seen throughout the world. The true intermodal era began in the 1980s with the expanding world economy, Panama Canal ship size restrictions, intermodal railway car (wagon) designs and the setting of ISO standards for international shipping containers.

Today's commonly seen steel all-corrugated ISO containers still have some variations, primarily the doors. This Atlas model represents a standard-height 40-footer which will exhibit a range of door styles, roofs, and front walls to more closely match the variations in the prototype containers seen throughout the world.

Features:

- Production rail guides
- Roof corner pads
- LTR style handles
- Separately applied door rods and handles
- Optional separate vents
- Prototypically accurate "beveled" all corrugated sides
- Each set comes as a 3-pack

Each set comes as a 3-pack!



Ocean Network Express (TLLU)



PRE-ORDER ANNOUNCEMENTS - JANUARY 2024

GUARANTEED PRE-ORDER DUE DATE: WEDNESDAY MARCH 13TH 2024



ATLAS TRAINMAN® HO 2-BAY OFFSET HOPPER

Product Info: <https://shop.atlasrr.com/d-714-100th-anniversary-catalog-1-ho.aspx>

**NEW
PAINT
SCHEMES**

**NEW
ROAD
NUMBERS**



Southern (A.G.S.)

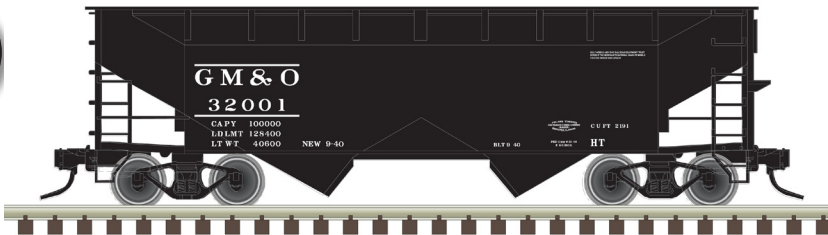

GM&O

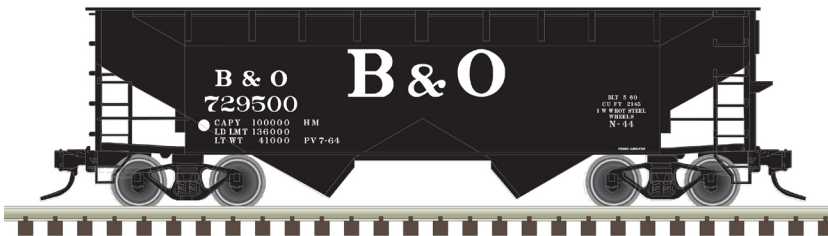

Baltimore & Ohio*

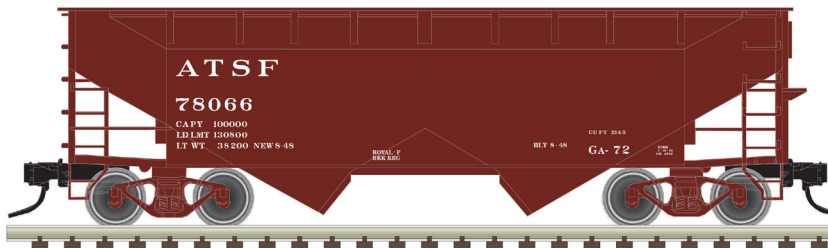

Santa Fe



Hallett

**CSX Licensed Product*



PRE-ORDER ANNOUNCEMENTS - JANUARY 2024

GUARANTEED PRE-ORDER DUE DATE: WEDNESDAY MARCH 13TH 2024



ATLAS TRAINMAN® HO 2-BAY OFFSET HOPPER

ESTIMATED ARRIVAL: 3rd Quarter 2024 Arrival

ORDER IN PIECES	ITEM	ROAD NAME	ROAD #	COLOR	MSRP / UNIT
NEW ROAD NUMBERS					
	20 007 430	Southern (A.G.S.)	320101	Black/White	\$26.95
	20 007 431	Southern (A.G.S.)	320253	Black/White	\$26.95
NEW PAINT SCHEME					
	20 007 433	Gulf, Mobile & Ohio	32001	Black/White	\$26.95
	20 007 434	Gulf, Mobile & Ohio	32033	Black/White	\$26.95
NEW ROAD NUMBERS					
	20 007 436	Baltimore & Ohio*	729500	Black/White	\$26.95
	20 007 437	Baltimore & Ohio*	729506	Black/White	\$26.95
	20 007 439	Santa Fe	78066	Oxide Red	\$26.95
	20 007 440	Santa Fe	78099	Oxide Red	\$26.95
NEW PAINT SCHEME					
	20 007 442	Hallett	9704	Green/White	\$26.95
	20 007 443	Hallett	9732	Green/White	\$26.95
3-PACK - NEW ROAD NUMBERS					
	20 007 432	Southern (A.G.S.) 320461, 320623, 320699		Black/White	\$80.85
3-PACK - NEW PAINT SCHEME					
	20 007 435	GM&O 32126, 32212, 32249		Black/White	\$80.85
3-PACK - NEW ROAD NUMBERS					
	20 007 438	Baltimore & Ohio* 729529, 729956, 730210		Black/White	\$80.85
	20 007 441	Santa Fe 78114, 78131, 78299		Oxide Red	\$80.85
3-PACK - NEW PAINT SCHEME					
	20 007 444	Hallett 9710, 9718, 9730		Green/White	\$80.85
TOTAL PIECES ORDERED					

In the aftermath of World War One United States railroads learned there were financial advantages to standardization of the freight car fleet. The newly formed Association of American Railroads was tasked with developing standard freight car designs for North American railroads. Out of this work came the AAR Standard 50 ton 2-Bay Offset Hopper.

Atlas' version of this 2-Bay Offset, open top hopper with flat ends is modeled after this AAR Standard design built from the mid 1930's through the 1960's to transport coal.

Features:

- Ready-to-run
- Blackened metal wheels
- Free-rolling 50-ton trucks
- Detailed brake gear
- Body mounted AccuMate® knuckle couplers
- Prototypical painting and lettering

AccuMate® couplers are made under license from AccuRail, Inc.

**CSX Licensed Product*

Need a Part for Your Atlas

It's never been easier with the new Atlas **PRODUCT/ORDER PARTS** link up pages. Go to the Atlas website shop.atlasrr.com and click on the scale (N, HO, O) and product (locomotive or rolling stock) you're looking for...

The screenshot shows the Atlas website home page. At the top left is the Atlas logo with the tagline "You're on the Right Track...with Atlas." and the text "MODEL RAILROAD CO., INC.". To the right is a search bar. Below the logo is a navigation menu with links for HOME, HO SCALE, N SCALE, O SCALE, Z SCALE, CATALOGS, PRODUCTION, DEALERS, BLOG, and INFORMATION. A large blue "N SCALE" graphic is prominent. A dropdown menu is open under "N SCALE", listing categories: PRODUCTS, TRACK, LOCOMOTIVES, ROLLING STOCK, PARTS, BLMA PARTS, LOCOMOTIVE PARTS, MISCELLANEOUS PARTS, and ROLLING STOCK PARTS. To the right of this menu is another dropdown menu for "ACCESSORIES" with sub-categories: BOOKS, BRIDGES, ELECTRICAL, GIFT CERTIFICATES, SIGNAL SYSTEM, STRUCTURES, and MISCELLANEOUS. Below the navigation is a "New Arrivals" section featuring a "SHOP NOW" button and a banner for "N, HO, O & Z Scale Track, Layouts & Accessories".

Once selected you arrive at the library of locomotives or rolling stock and click on the product of interest...

The screenshot shows the Atlas website product page for "N MASTER LOCOMOTIVE SPARE PARTS". The page features a grid of eight product images, each with a caption below it. The products are: N MASTER GP-7/9 LOCOMOTIVE..., N MASTER 2-6-0 MOGUL STEAM..., N MASTER 4-4-0 LOCOMOTIVE S..., N MASTER SHAY LOCOMOTIVE P..., N MASTER MP-15DC LOCOMOTI..., N MASTER U23B LOCOMOTIVE S..., N MASTER GP38-2 LOCOMOTIVE..., and N MASTER C420 LOCOMOTIVE S... The page also includes the Atlas logo, tagline, and navigation menu at the top.

Locomotive or Rolling Stock?

Selecting the product of interest takes you to an exploded diagram and the **ORDER PARTS** page...

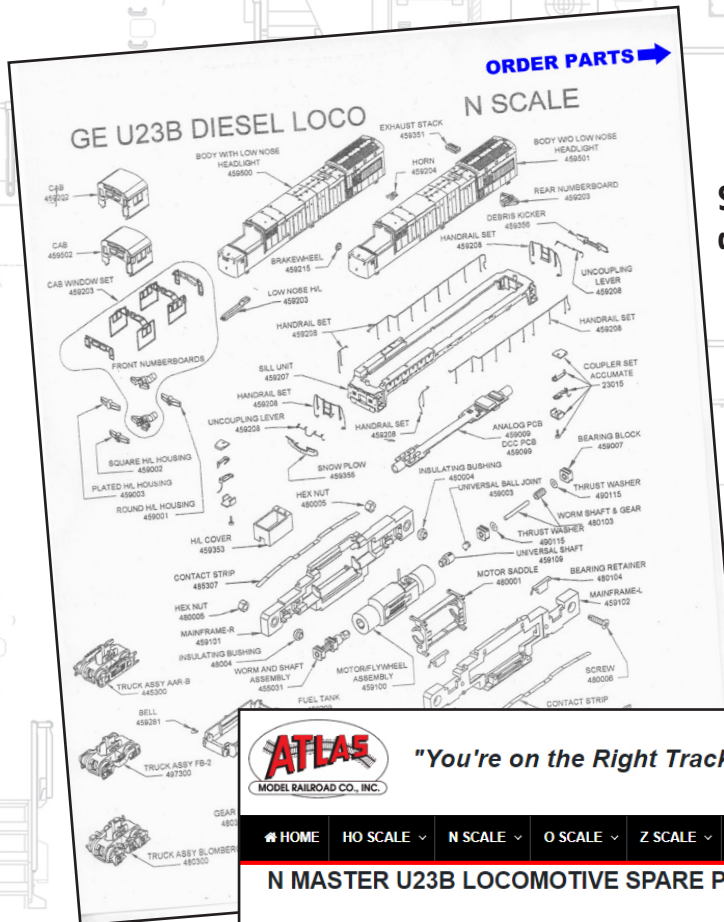

Sample Locomotive Exploded Diagram (left) and Order Parts Page (below)

ATLAS "You're on the Right Track...with Atlas."®
MODEL RAILROAD CO., INC.





Search

HOME HO SCALE N SCALE O SCALE Z SCALE CATALOGS PRODUCTION DEALERS BLOG INFO

N MASTER U23B LOCOMOTIVE SPARE PARTS

[Click Here for Exploded Diagram](#)

Sort By: Best Match

			
N U23B analog PCB MSRP: \$11.50 ITEM# 459009	N U23B MAIN FRAME RIGHT MSRP: \$5.45 ITEM# 459101	N U23B MAIN FRAME LEFT MSRP: \$5.45 ITEM# 459102	N U23B PLATED HL HOUSING MSRP: \$5.45 ITEM# 459003

**Atlas Model Railroad Customer Service experts are available at:
908-687-0880**

Put Your Trains on the Right Track!

With time tested, modeler approved Atlas HO & N scale track!

Whether you're finishing an existing layout, starting a new one, or just giving that trainset loop some extra pieces, Atlas has the 'right track' for you. The rugged plastic construction, nickel silver rail and U.S. prototype detail, assures longevity, maximum conductivity and accurate realism that guarantees your trains look good and keep running smoothly. Atlas track provides industry leading **quality** at unequalled **value**, and our **selection** is so large we have an entire catalog devoted to it. HO and N scale track, in a variety of rail sizes, is fully stocked and ready to ship to you and your favorite Atlas authorized dealer now. For more information, and the dealer nearest you, visit shop.atlasrr.com and request a catalog of your own. And remember... *You're on the right track...with Atlas!*

HO SCALE TRACK

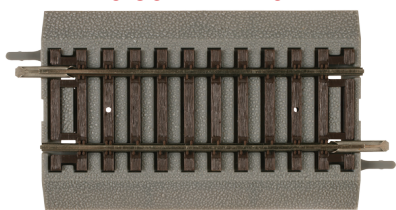

HO True-Track®

Atlas HO True-Track® has true-to-life gray gravel bed, correctly angled roadbed shoulders and features Atlas Code 83 Snap-Track®.



HO Code 83

Atlas HO Code 83 track features prototypically-fine brown ties and nickel silver rail, and not only looks realistic but is incredibly reliable.



HO Code 100

Atlas HO Code 100 track features black injection molded plastic ties and solid nickel silver rail, and is suitable for all skill levels.

N SCALE TRACK

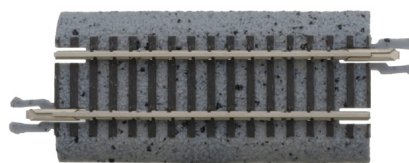

N True-Track®

Atlas N True-Track® features Code 65 rail & dark brown ties with prototypical spacing and is now improved with true-to-life gray gravel bed making it even more realistic!

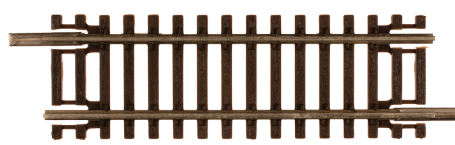

N Code 55

Atlas N Code 55 track features simulated wood brown ties and smaller nickel silver rail, and is praised for its superior design and ease of use.

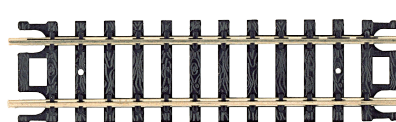

N Code 80

Atlas N Code 80 track features black ties and nickel silver rail, and is built to last for ultimate performance.

ATLAS SUPER-FLEX® TRACK

- Item #168 HO Code 100 Super Flex Track
- Item #500 HO Code 83 Super Flex Track

- Item #2000 N Code 55 Super Flex Track
- Item #2500 N Code 80 Super Flex Track

Invented and patented by Atlas founder Stephen J. Schaffan Jr., this innovative, finely engineered precision track is the first choice of experts who demand the best. Easy to install, Super-Flex Track® enhances the realism of your layout. Unlike other flexible track which can become inflexible and kink, Atlas' Super-Flex Track® can be formed and re-formed with ease to achieve the desired shape. This unique track can be shaped to form curves of any radius, is ideal for spiral easement curves and is easily manipulated to help you make your layout vision a reality.



**ATLAS
SUPER-FLEX® TRACK**
the original and still the best.

ACCEPT NO IMITATORS.



Visit shop.atlasrr.com for more information on Atlas track & accessories, the All Scales Signal System, locomotives, rolling stock, & more!



ATLAS MODEL RAILROAD CO, INC. • 378 Florence Ave., Hillside, NJ 07205 • shop.atlasrr.com

Atlas Keeps the Trains Rollin'

You built your layout with Atlas track - the best track around, now you'll want to run the best trains! Our locomotives and rolling stock don't just look fantastic, they run like a dream and the details & features are second to none. With several different lines to choose from, we have you covered no matter the era!

Master and Classic Line Locomotives & Rolling Stock

Atlas Master and Classic Line trains are top-of-the-line and feature the highest level of detail we offer. Each model comes ready-to-run, which means no assembly is required. Sometimes we include small plastic or etched metal detail parts for you to apply, to add a finishing touch. Locomotives from these lines are noted for their reliability and smooth operation.



MASTER LINE  LOCOMOTIVES

MASTER LINE  ROLLING STOCK

Classic



Trainman Line Locomotives & Rolling Stock

Atlas Trainman Line products use the same drive train and feature the same prototypical accuracy as our other lines, but the shells have less separate detail added, and are generally offered in fewer variations or phases for each model as compared to our Master line.



TRAINMAN



Licensed, Limited Edition & Special Run Models

While Atlas takes great pride in prototypical accuracy, we also enjoy creating fun, commemorative paint schemes to help modelers celebrate the holidays. We also partner with multiple brands to offer licensed models such as our 40' Plug Door Box Cars decorated with beer branded paint schemes! Still don't see what you've been dreaming of? Why not order it as a special run? Atlas offers the ability for customers to do custom runs on any model we currently make, provided you meet the minimum order quantities.



Visit shop.atlasrr.com for more information on our locomotives, rolling stock, track & accessories, signal system & more!



Bring Your Layout to Life!

With Layout Details, Structures & Accessories from Atlas!



Item #2840 - N Signal Tower Kit

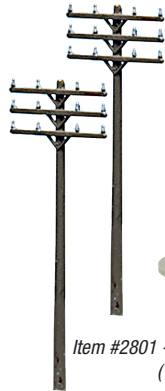

Item #2801 - N Telephone Poles (12 pcs.)

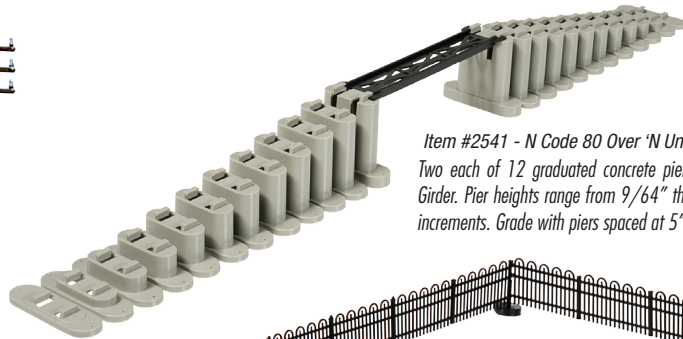

Item #2541 - N Code 80 Over 'N Under Pier Set (25 pcs.)
Two each of 12 graduated concrete piers plus #2542 Straight Pier Girder. Pier heights range from 9/64" through 1-11/16" by 9/64" increments. Grade with piers spaced at 5" intervals is 2.8%.

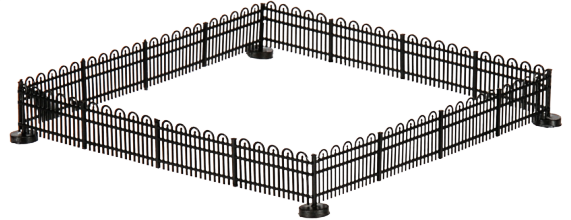

Item #2850 - N Hairpin Style Fence



Item #776 - HO Picket Fence & Gate Kit (72")



Item #2841 & 2842 - N Passenger Station Kit & N Station Platform Kit



Item #760 - HO Roadside Restaurant Kit



Item #779- HO Sheep (12 white, 1 black)



Item #793- HO Undecorated Pedestrian Figures (24 pcs. - Pictured Decorated)



Item #2851 - N Kim's Classic Home Kit



Item #721 - HO Middlesex Manufacturing Co. Kit

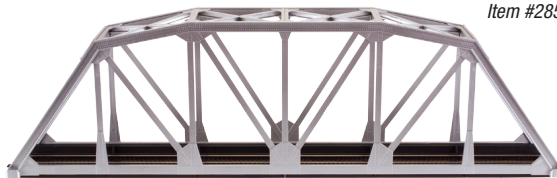

Item #594 - HO Code 83 18" Through Truss Bridge Kit (Silver) (9" x 2-1/2" x 2")



Item #883 - HO Code 100 Warren Truss Bridge (9" x 2-1/2" x 2")



Visit shop.atlasrr.com for more information on Atlas track & accessories, the All Scales Signal System, locomotives, rolling stock, & more!

Full product line not pictured. Visit shop.atlasrr.com for a full listing of available accessories.



Operating Signals Create an Authentic RR Experience

With Atlas' All Scale Signal System!

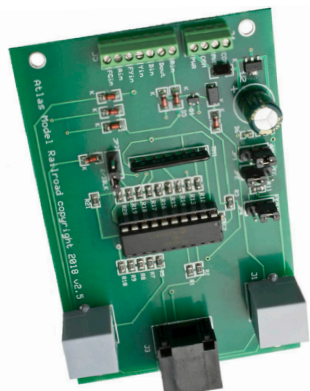

Item #70 000 046
Universal Signal Control Board

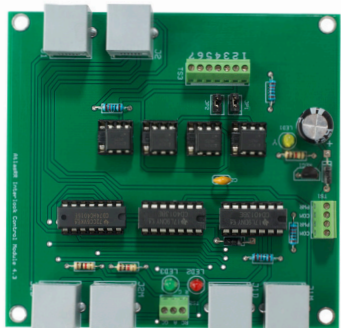

Item #70 000 047 - Interlock Control Module



Item #70 000 050 -
Signal Attachment Cable
additional cable styles and lengths
are available



Item #70 000 060 -
Universal Cable
Connector



Item #70 000 143 - N Scale Signal System Starter Kit
contains: 1- 70 000 102 N Type G Signal
1- 70 000 046 Universal Signal Control Board
1- 70 000 050 Signal Attachment Cable
1- Quick Start Guide



Item #70 000 102 -
N Signal,
Type G, Single Head



Item #70 000 103
N Signal, Type G, Double Head,
Common Cathode



Item #70 000 104
N Signal, Type G, Bidirectional,
Common Cathode

Item #70 000 104 - N Signal
Type G, Bidirectional



Item #70 000 142 - HO Scale Signal System Starter Kit
contains: 1- 70 000 076 HO Type G Signal
1- 70 000 046 Universal Signal Control Board
1- 70 000 050 Signal Attachment Cable
1- Quick Start Guide



Item #70 000 076 - HO Signal,
Type G, Single Head



Item #70 000 077 - HO Signal,
Type G, Double Head



Item #70 000 098 - HO Signal, Modern
Cantilever Bridge, 2 Track, 4 Head, LH
Also available: Item #70 000 099 - HO Signal,
Modern Cantilever Bridge, 2 Track, 4 Head, RH



Visit shop.atlasrr.com for more information on the All Scale Signal System,
track, locomotives, rolling stock, & more!

Full product line not pictured.
Visit shop.atlasrr.com for a
listing of all signal products.



Visually Stunning Spans



NEW HO VIADUCT KITS FROM ATLAS

NEW PRODUCT
AVAILABLE NOW!



The Atlas Expandable Viaduct Kits will be available in three different surfaces – Concrete, Cut Stone, and Rough Stone – and in single and double-track widths. Pre-production Concrete Single Track Kit shown assembled.

Features:

- Kit contains single arch and two half-arch ends – combine kits for longer applications
- Can be used w/o pier units for lower heights such as in urban settings
- Concrete double track viaduct also suitable for O scale single track applications
- Length 18"; Width – overall (Single) 3 1/4", (Double) 5 1/4"; Width – btw. walkways (Single) 2 1/8", (Double) 4 1/8"
- Height (w/ piers) – to deck 9 5/8", to top of railings 10 3/8"; Height (w/o piers) – to deck 3 1/2", to top of railings 4 1/4"



For more information on these and other high quality Atlas products,
visit your local hobby shop or www.atlasrr.com!



ATLAS MODEL RAILROAD CO., INC. • 378 Florence Ave., Hillside, NJ 07205 • www.atlasrr.com