

HOBBY STORE ARRIVALS

Below are the products arriving at your hobby stores for April-July 2008. This index will help you find the model you are looking for and its pertinent info quickly and easily. If you don't see the product you're looking for, please visit our home page at www.atlasrr.com and check out our comprehensive A-Z Shipping Schedule for the most up-to-date information on announcements and shipping dates.

'Arrivals' are products that are currently in hobby stores or will be delivered to hobby stores between April and July of 2008.

MODEL NAME

CATALOG PAGE

APRIL ARRIVALS

N Trainman® 70 Ton Ore Car page 100

MAY ARRIVALS

N Master™ RS-3 Locomotives..... page 101

N Master™ 2-Bay Offset Hopper page 102

N Master™ 45' Pines Trailers page 102

N Trainman® 40' PS-1 Box Car page 103

N Trainman® 5250 Hopper page 103

JUNE ARRIVALS

N Master™ C420 Locomotives..... page 104

N Ford® Tractor Cabs page 105

N Trainman® 50' Single Door Box Car page 106

JULY ARRIVALS

N Master™ DASH 8-40C Locomotives page 107

N Master™ ACF® 5800 Centerflow Plastics & Grain Hoppers..... page 108

N Kim's Classic American Home page 108

N Trainman® N Thrall 4750 Hopper page 109

April 2008 STORE ARRIVAL

N Trainman® 70 Ton Ore Car - <http://www.atlasrainman.com/NFreight/tmn70tonore.htm>



Canadian National



Canadian Pacific



Canadian National



Erie Mining



Great Northern



Southern Pacific



Pere Marquette*



Union Pacific

Road Name/Road Numbers

Item

N TRAINMAN® 70 TON ORE CAR- NEW PAINT SCHEMES!

Undecorated	3200
Canadian National 114132, 114263	39984A - 39985A
Erie Mining 2301, 2319	39986A - 39987A
Great Northern 95310, 95331	39988A - 39989A
Pere Marquette* CF1512, CF1523	39990A - 39991A
Southern Pacific 467501 467520	39992A - 39993A

N TRAINMAN® 70 TON ORE CAR- NEW ROAD NUMBERS!

Canadian National 343003, 343041	39962B - 39963B
Canadian Pacific 377210, 377222	39964B - 39965B
Union Pacific 26422, 26469	39994B - 39995B

Standard MSRP: \$7.95 Undecorated MSRP: \$6.95

*CSX Licensed Product

N Scale Highlight

N Master™ C420 phase 2A & phase 2B Locomotive!

This latest addition to Atlas' N Scale fleet of highly detailed Master Line™ locomotives, an all-new low-nose "phase 2" C420, is due to arrive in hobby shops in June 2008. All phase 2 versions will feature the low/vertical mounted engine air intake located ahead of the radiator area on the long hood. Early phase 2 locomotives feature phase 1-style walkways/sills with stanchions mounted into the top walkway deck (referred to as "Phase 2a" models). Later phase 2 locomotives feature a revised configuration where the stanchions are mounted to the sides of the sill (referred to as "phase 2b" models).

Phase 2a production ran from December 1964 through September 1965. Phase 2b units were produced from December 1965 through the end of C420 locomotive production in August 1968.

Features of this beautifully painted and decorated locomotive include flat or "step" pilots used where appropriate, long hood with or without dynamic brake where appropriate, 3,100 or 2,400 gallon fuel tank used when appropriate per road name, separately-applied coupler cut levers, painted safety rails, dual flywheels, directional lighting, blackened metal wheels, Scale Speed™ motor, factory installed AccuMate® magnetic couplers, and low nose headlight in low position where appropriate per road name.

To see the available road names, and road numbers, please visit www.atlasrr.com/nloco/nc420a.htm and page 104 of this catalog.



(Item #40000026)

Highly Detailed!

MAY 2008 STORE ARRIVAL

N Master™ RS-3 Locomotives - <http://www.atlasrr.com/NLoco/nrs34.htm>



Long Island



Burlington Northern



Jersey Central (Coast Guard Scheme)



Rock Island



Rutland



Green Bay & Western



Spokane, Portland & Seattle



Lehigh & Hudson River



Ontario Northland

Road Name/Road Numbers	Item #
N RS-3 LOCOMOTIVE - NEW ROAD NUMBERS!	
Undecorated	42000
Burlington Northern 4056, 4064	42062 - 42063
N RS-3 LOCOMOTIVE - NEW PAINT SCHEMES!	
Green Bay & Western 305, 307	42064 - 42065
Jersey Central (Coast Guard Scheme) 1540, 1546	42066 - 42067
Lehigh & Hudson River 4, 11	42068 - 42069
Long Island 1551, 1555	42070 - 42071
Ontario Northland 1306, 1308	42072 - 42073
Rock Island 455, 458	42074 - 42075
Rutland 205, 208	42076 - 42077
Spokane, Portland & Seattle 66, 79	42078 - 42079
MSRP: \$104.95	

MAY 2008 STORE ARRIVAL

N Master™ 2-Bay Offset Hopper - <http://www.atlasrr.com/NFreight/n2bayoffsethopper.htm>



Canadian Pacific



Jersey Central



Baltimore & Ohio*



Erie

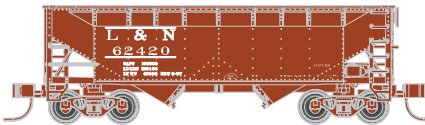

Louisville & Nashville*

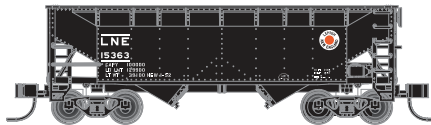

Lehigh & New England

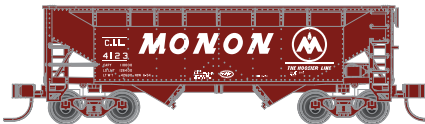

Monon*

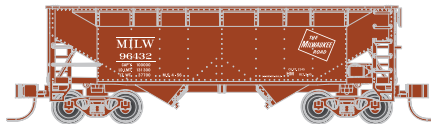

Milwaukee Road

Road Name/Road Numbers

Item

N 2-BAY OFFSET SIDE HOPPER - NEW MODEL!

Undecorated - Flat End	40800
Baltimore & Ohio* 640460, 640499	40801 - 40802
Canadian Pacific 357001, 357189	40803 - 40804
Erie 28007, 28279	40805 - 40806
Jersey Central 10258, 10311	40807 - 40808
Lehigh & New England 15123, 15363	40809 - 40810
Louisville & Nashville* 62214, 62420	40811 - 40812
Milwaukee Road 96244, 96512	40813 - 40814
Monon* (C.I.L.) 4019, 4123	40815 - 40816

N 2-BAY OFFSET SIDE HOPPER 3-PACKS - NEW MODEL!

Baltimore & Ohio* 640475, 640483, 640515	5600
Canadian Pacific 357044, 357150, 357249	5601
Erie 28000, 28120, 28301	5602
Jersey Central 10285, 10303, 10347	5603
Lehigh & New England 15187, 15206, 15314	5604
Louisville & Nashville* 62266, 62493, 62601	5605
Milwaukee Road 96091, 96347, 96432	5606
Monon* (C.I.L.) 4010, 4099, 4142	5607

**Standard MSRP: \$15.95 Undecorated MSRP: \$13.95
3-Pack MSRP: \$47.85**

*CSX Licensed Product

MAY 2008 STORE ARRIVAL

N Master™ 45' Pines Trailers - <http://www.atlasrr.com/NFreight/ntrailers4.htm>



Xtra Lease



Vermont Railway



Burlington Motor Carriers

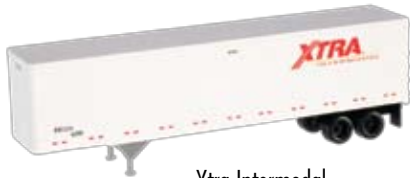

Xtra Intermodal



Preferred 45



Chicago Central & Pacific



Milwaukee Road

Road Name/Road Numbers

Item

N 45' PINES TRAILER - NEW ROAD NUMBERS!

Undecorated	2960
Chicago Central & Pacific* 230033, 230250	29612 - 29613
Vermont Railway* 237630, 238000	29662 - 29663
Xtra Intermodal* 231130, 231154	29672 - 29673
Xtra Lease* 850235, 850319	29682 - 29683
Burlington Motor Carriers* A11022, A11029	29692 - 29693
Milwaukee Road 251015, 251020	29723 - 29724
Preferred 45 254333, 254347	29733 - 29734

Standard MSRP: \$12.95 Undecorated MSRP: \$7.95

*Paint Schemes are correct for 45' Trailers manufactured by Pines
HO Models Shown

MAY 2008 STORE ARRIVAL

N Trainman® 40' PS-1 Box Car - <http://www.atlastrainman.com/NFreight/tmn40ps1.htm>



Western Pacific



Toronto, Hamilton & Buffalo



Burlington Route



Richmond, Fredericksburg,
& Potomac



Vermont Railway



Western Maryland*

Road Name/Road Numbers	Item #
N TRAINMAN® 40' PS-1 BOX CAR - NEW PAINT SCHEMES!	
Undecorated	3400
Burlington Route 63001, 63114	34606A - 34607A
Richmond, Fredericksburg & Potomac 2814, 2839	34608A - 34609A
Toronto, Hamilton & Buffalo 3666, 3694	34610A - 34611A
Vermont Railway 341, 365	34612A - 34613A
Western Maryland* 4225, 4323	34614A - 34615A
Western Pacific 20821, 20959	34616A - 34617A
Standard MSRP: \$9.95	Undecorated MSRP: \$7.95

*CSX Licensed Product

MAY 2008 STORE ARRIVAL

N Trainman® 5250 Hopper - <http://www.atlastrainman.com/NFreight/tmn5250.htm>

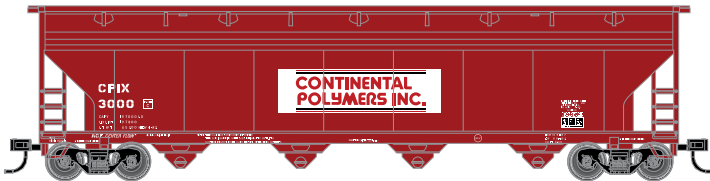

Continental Polymers (CPIX)

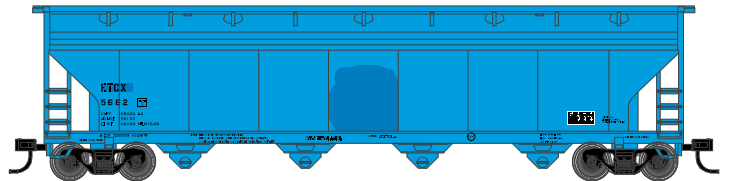

Eastman Chemical (ex-CSPX)

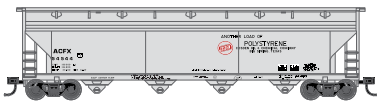

Cosden Oil & Chemical

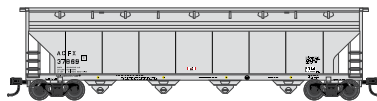

General Electric "5251"



El Rexene

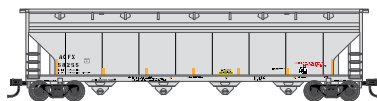

General Electric Railcar
"Conspicuity Stripes"

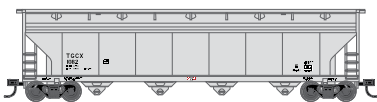

The Polyone Company

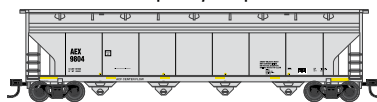

The Andersons

Road Name/Road Numbers	Item #
N TRAINMAN® ACF® 5250 HOPPER - NEW TO TRAINMAN®!	
Undecorated	3950
The Andersons 9804, 9825	50 000 085 - 50 000 086
Continental Polymers (CPIX) 1000, 3000	50 000 087 - 50 000 088
Cosden Oil & Chemical 54544, 54550	50 000 089 - 50 000 090
Eastman Chemical (ex-CSPX) 5662, 5677	50 000 091 - 50 000 092
El Rexene 53807, 53844	50 000 093 - 50 000 094
General Electric Railcar "5251" 37869, 37950	50 000 095 - 50 000 096
General Electric Railcar "Conspicuity Stripes" 58255, 58273	50 000 097 - 50 000 098
The PolyOne Company (Rescar Repaint) 1082, 1094	50 000 099 - 50 000 100
Standard MSRP: \$9.95	Undecorated MSRP: \$7.95

JUNE 2008 STORE ARRIVAL

N Master™ C420 LOCOMOTIVES - <http://www.atlasrr.com/NLoco/nc420a.htm>



Susquehanna



British Columbia Railway



Seaboard Air Line*



Lehigh & Hudson River



Monon*



Piedmont & Northern*

Road Name/Road Numbers	Standard Item #	Decoder Item #
N C420 PHASE 2A LOCOMOTIVES - NEW MODEL!		
Undecorated ^y Low Nose w/o nose light	40 000 002	40 000 102
Seaboard Air Line* ^y 111, 116, 118	40 000 023-40 000 025	40 000 119-40 000 120
N C420 PHASE 2B LOCOMOTIVES - NEW MODEL!		
Undecorated Low Nose w/o nose light	40 000 004	40 000 104
Undecorated Low Nose w/ nose light	40 000 005	40 000 105
British Columbia Railway 631, 632	40 000 026-40 000 027	40 000 121-40 000 122
Lehigh & Hudson River 26, 29	40 000 028-40 000 029	40 000 123-40 000 124
Monon* ^y 505, 506, 509	40 000 030-40 000 032	40 000 125-40 000 126
Piedmont & Northern* 2000, 2001	40 000 033-40 000 034	40 000 127-40 000 128
Susquehanna [†] 2000	40 000 035	40 000 129
MSRP: \$109.95		Decoder-Equipped MSRP: \$139.95

*CSX Licensed Product

^yModel equipped with dynamic brakes

[†]Model includes low nose headlight

Check with your local hobby store for product availability

JUNE 2008 STORE ARRIVAL

N Ford® Tractor Cabs - <http://www.atlasrr.com/NFreight/ntractorcabs4.htm>



Cory's Cartage



RP Transfer

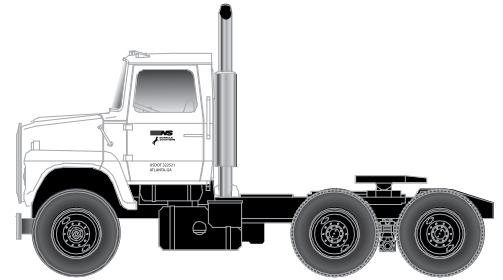

Norfolk Southern

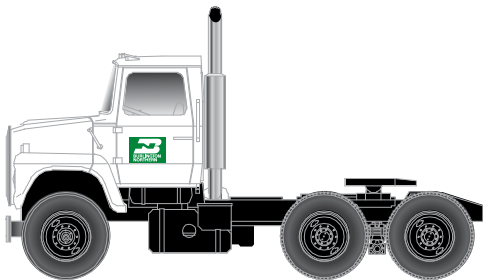

Burlington Northern

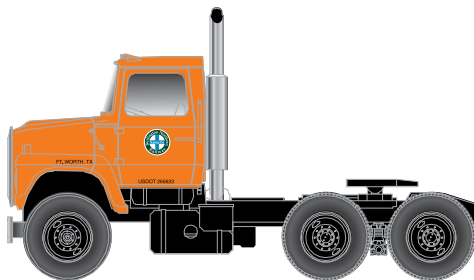

BNSF



This is an officially licensed product by the Ford Motor Company®.

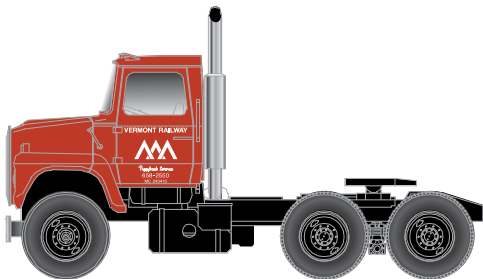

Vermont Railway



CSX*

Road Name	Item #	MSRP
N FORD® TRACTOR CABS NEW PAINT SCHEMES!		
Burlington Northern	60 000 020	\$14.95
Delaware & Hudson	60 000 021	\$14.95
Providence & Worcester	60 000 022	\$14.95
Vermont Railway	60 000 023	\$14.95

Road Name	Item #	MSRP
N FORD® TRACTOR CABS MOW KITBASHER'S SERIES†		
BNSF	60 000 024	\$14.95
CSX*	60 000 025	\$14.95
Kansas City Southern	60 000 026	\$14.95
Norfolk Southern	60 000 027	\$14.95
Union Pacific	60 000 028	\$14.95

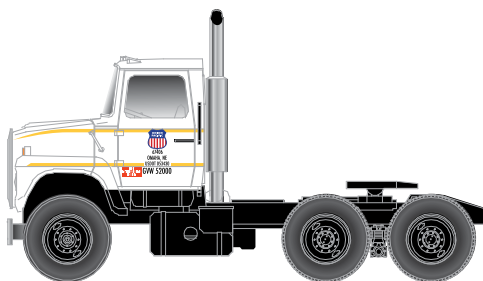

Union Pacific

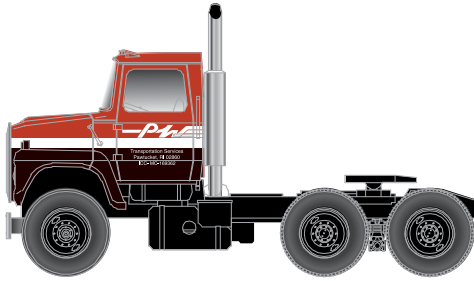

Providence & Worcester

Road Name	Item #	MSRP
N FORD® TRACTOR CABS - RE-RUN ITEMS!		
Cory's Cartage	60 000 000	\$14.95
DC Transportation	60 000 001	\$14.95
RP Transfer	60 000 002	\$14.95
Undecorated	2920	\$9.95
Black	2921	\$12.50
Dark Blue	2922	\$12.50
Green	2923	\$12.50
Red	2924	\$12.50
White	2925	\$12.50
Yellow	2926	\$12.50
Medium Blue	2927	\$12.50
Orange	2928	\$12.50
Dark Green	2913	\$12.50
Brown	2914	\$12.50
Gray	2915	\$12.50
Orange/Blue	2916	\$14.95
Red/White	2917	\$14.95
White/Black	2918	\$14.95
Yellow/Green	2919	\$14.95

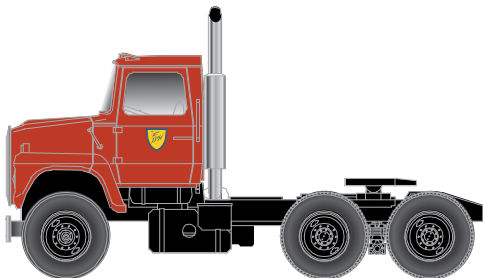

Delaware & Hudson



Kansas City Southern

MSRP: \$9.95-\$14.95

*CSX Licensed Product

JUNE 2008 STORE ARRIVAL

N Trainman® 50' Single Door Box Car - <http://www.atlstrainman.com/NFreight/tmn50sdboxcar.htm>



Norfolk & Western



Bangor & Aroostook



Delaware, Lackawanna, & Western



Seaboard Air Line



Pennsylvania

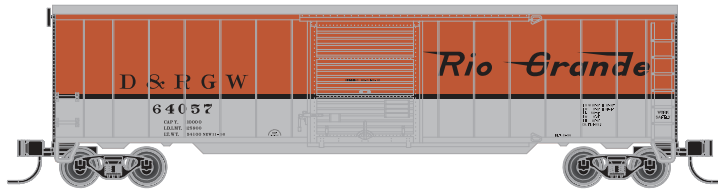

Rio Grande

Road Name/Road Numbers	Item #
ATLAS N TRAINMAN® 50' SINGLE DOOR BOX CAR	
NEW TOOLING!	
Undecorated	38900
Bangor & Aroostook 10362, 10405	38901A - 38902A
Delaware, Lackawanna & Western 12079, 12098	38903A - 38904A
Norfolk & Western 55915, 55991	38905A - 38906A
Pennsylvania 73079, 73173	38907A - 38908A
Rio Grande 64057, 64064	38909A - 38910A
Seaboard Air Line® 27093, 27190	38911A - 38912A
Standard MSRP: \$10.95	
Undecorated MSRP: \$8.95	

*CSX Licensed Product

N SCALE Highlight

The Summer is Sizzlin' with...

N Master™ ACF® 5800 Centerflow Plastics & Grain Hoppers!

Don't wait to order this new Atlas Master Line™ freight, due to arrive in hobby shops in July. You'll marvel at its exceptional features - nine full-width panel body with ten weld seams! Ten 20" hatches or continuous hatch (grain)! Pneumatic or gravity outlets (grain)! It's a sure-fire way to enhance your summer model railroading enjoyment.

The 5800 cubic foot covered hopper evolved from the earlier 5701 for transporting bulk plastic pellets. Most of these were acquired by private companies including leasing companies, chemical companies, oil companies, and plastics companies.

Additional features include etched metal roof walks, transverse mounted air reservoir, continuous hatch and gravity outlets (5748 Grain), 100-ton roller-bearing trucks and AccuMate® couplers. To admire the fine details, paint schemes and road numbers for yourself, please visit www.atlasrr.com/NFreight/n5800cf.htm and page 108 of this catalog.

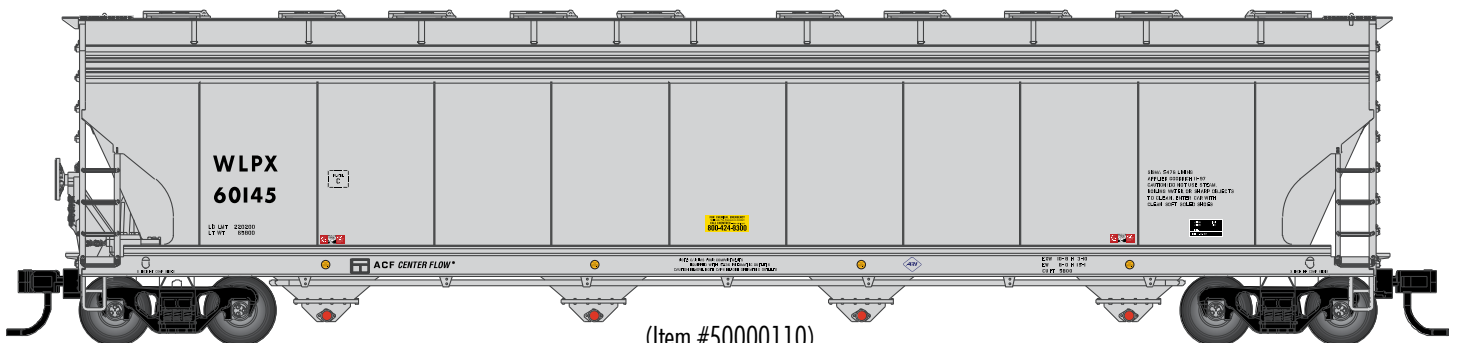

(Item #50000110)

July 2008 STORE ARRIVAL

N Master® DASH 8-40C Locomotives - <http://www.atlasrr.com/NLoco/ndash840c.htm>



Union Pacific



CSX*



Conrail



Chicago & North Western



Norfolk Southern

Road Name/Road Number	Standard Item #	Decoder Item #
N DASH 8-40C LOCOMOTIVES - NEW MODEL!		
Undecorated - Phase 1	51800	-
Undecorated - Phase 2	51801	-
Chicago & North Western 8501, 8503, 8518	51802-51804	51851-51852
Conrail 6025, 6039, 6045	51805-51807	51853-51854
CSX* 7503, 7545, 7551	51808-51810	51855-51856
Norfolk Southern 8692, 8698, 8709	51811-51813	51857-51858
Union Pacific 9234, 9240, 9247	51814-51816	51859-51860
MSRP: \$109.95		Decoder-Equipped MSRP: \$149.95

(HO Models Shown)

*CSX Licensed Product

Check with your local hobby store for product availability

July 2008 STORE ARRIVAL

N Master® ACF® 5800 Centerflow Plastics & Grain Hoppers - <http://www.atlasrr.com/NFreight/n5800cf.htm>

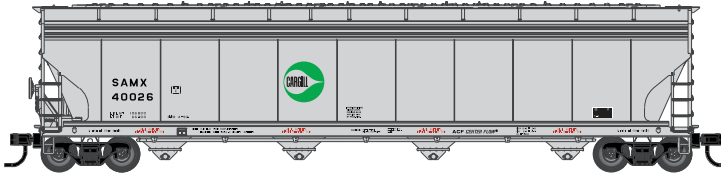

Cargill

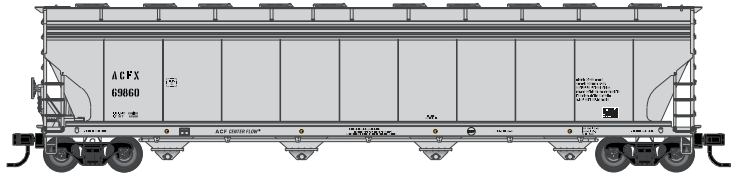

ACF® Industries

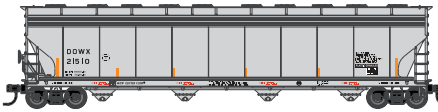

Dow Chemical

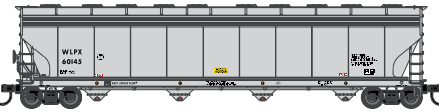

Westlake Polymers



Occidental Chemical

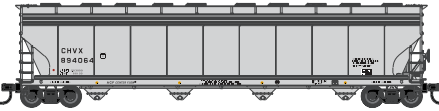

Chevron

Road Name/Road Numbers

Item

N ACF® 5800 CENTERFLOW PLASTICS HOPPER

NEW MODEL!

Undecorated	50 000 101
ACF® Industries 69860, 69918	50 000 102-50 000 103
Chevron 894001, 894064	50 000 104-50 000 105
Dow Chemical 21497, 21510	50 000 106-50 000 107
Occidental Chemical 71165, 71170	50 000 108-50 000 109
Westlake Polymers 60145, 60168	50 000 110-50 000 111

N ACF® 5748 CENTERFLOW GRAIN HOPPER

NEW MODEL!

Undecorated	50 000 126
Cargill 40026, 40088	50 000 112-50 000 113

Standard MSRP: \$21.95 Undecorated MSRP: \$15.95

July 2008 STORE ARRIVAL

N Kim's Classic American Home - <http://www.atlasrr.com/Trackmisc/nkimshouse.htm>



N Kim's Classic American Home Kit



N Kim's Classic American Home Build-ups

FEATURES:

- Approximate Dimensions: 3-1/2" x 1-3/4" x 2-1/2"

Road Name

Item

MSRP

N KIMS CLASSIC AMERICAN HOME - NEW MODEL!

Kim's Classic American Home—Kit	2851	\$20.95
Kim's Classic American Home—Built-Up	2852-1, -2, -3	\$34.95
• 2852-1 Maroon/Taupe/Cream/Black		
• 2852-2 Tan/Mustard/Yellow/Cream/Dark Green		
• 2852-3 Light Blue/Dark Blue/Beige/Black		

(HO models shown; scenery and cars not included)

Check with your local hobby store for product availability

July 2008 STORE ARRIVAL

N Trainman® N Thrall 4750 Hopper - <http://www.atlstrainman.com/NFreight/tmthrall4750.htm>

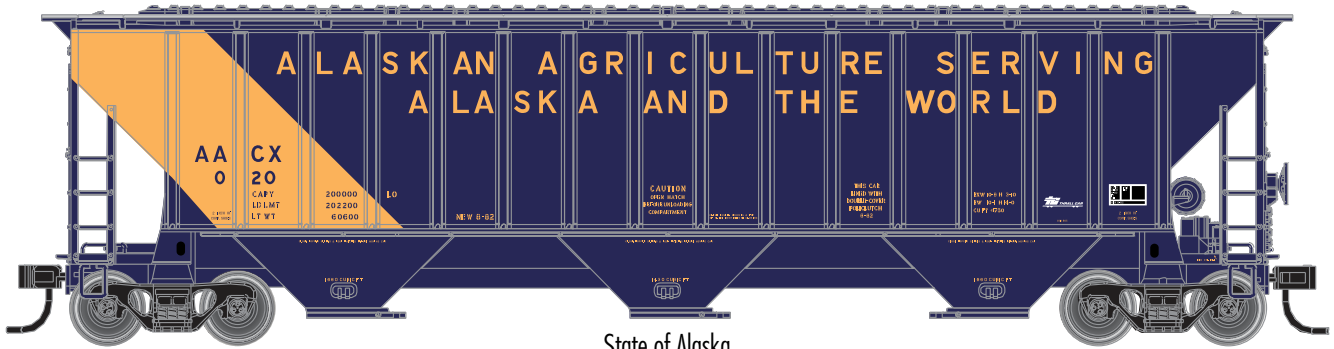

State of Alaska

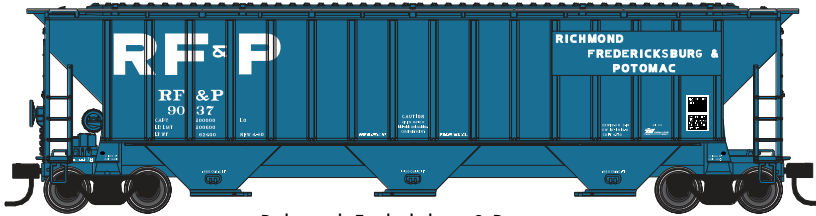

Richmond, Fredricksburg & Potomac



BNSF

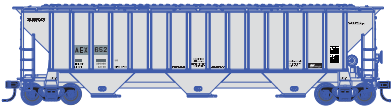

The Andersons

Road Name/Road Numbers	Item #
ATLAS N TRAINMAN® THRALL 4750 COVERED HOPPER NEW PAINT SCHEMES!	
Undecorated	50 000 027
State of Alaska (AACX) 008, 020	50 000 127-50 000 128
The Andersons 647, 652	50 000 129-50 000 130
BNSF 431023, 431080	50 000 131-50 000 132
Richmond, Fredericksburg & Potomac 9029, 9037	50 000 133-50 000 134
Standard MSRP: \$10.95 Undecorated MSRP: \$8.95	

N SCALE Highlight

N Master™ DASH 8-40C Locomotive - New Model!

Things will be heating up this July at your local hobby shop when the all-new Atlas N Dash8-40C locomotives roll in! Sizzling with the fine details only Atlas Master Line™ can deliver, these stunning locomotives come in phase 1 and phase 2 undecorated versions, as well as five road names with three road numbers each. Atlas Master Line® locomotives are the epitome of high quality, prototypical accuracy, superior performance and fine detailing, built to the strictest standards of research, engineering and production. They are specifically designed to bring the discriminating modeler many hours of smooth performance and impressive pulling power.

First built for Union Pacific in the late 1980s by General Electric, the DASH 8-40C diesel locomotives were identified by an enlarged exhaust stack and the mounting of the dynamic brake grids in a square-like unit behind the cab, which housed an enlarged equipment blower fan. These six-axle, 4,000 hp engines are still in service today throughout North America.

The hot, hot Atlas version features a separate coupler cut lever, directional lighting, golden white LEDs, painted safety rails, blackened metal wheels, dual flywheel equipped 5-pole skewed armature motor with a low friction mechanism, and factory-installed AccuMate® magnetic knuckle couplers.

Don your shades and check them out at www.atlasrr.com/nloco/ndash840c.htm and on page 107 of this catalog.



(Item #51803)

Summer Exclusive!